



TOGGLER[®]
HIGH-PERFORMANCE ANCHORS[®]

wej-it[®]
FASTENING SYSTEMS

Mechanical and Adhesive Anchors

for Masonry,
Concrete and
Drywall

Buyer's Guide
2012

*We didn't build the USA,
but we do hold it together!™*

Two Proven Product Lines – Now Together!

Over 100 Years of Fastening Experience

TOGGLER®
HIGH-PERFORMANCE ANCHORS®

wej-it®
FASTENING SYSTEMS



Since its inception in 1968, TOGGLER Anchor System, division of Mechanical Plastics Corp., has continued to invent, improve, manufacture and sell only TOGGLER® brand anchors, the highest quality, best-performing anchors on the market. All are designed to solve real problems on the job site and at home.

High-strength, multi-functional TOGGLER High-Performance Anchors® provide fast, easy, and secure fastening in many applications and substrates, from light- to heavy-duty.

We are the only manufacturer that proudly makes all of its anchors in the USA and the only one that puts its name on every anchor.

You can always rely on TOGGLER anchors to work properly the first time, every time.



Wej-It®, the original wedge anchor, first came on the scene over 60 years ago. Today professional installers around the world still rely on its outstanding performance. Over the years, the quality and reliability of the Wej-It brand has expanded into a full range of mechanical and adhesive concrete and drywall fasteners.

Wej-It Fastening Systems is now the newest division of Mechanical Plastics Corp. This means the proven reliability of Wej-It products is combined with the high level of customer service and support that has been provided to TOGGLER customers for over 44 years.

Investment into updated processes and technology will ensure the best quality concrete anchoring systems available to meet your high-strength concrete anchoring needs now and in the future.

We didn't build the USA, but we do hold it together!™

TOGGLER®
HIGH-PERFORMANCE ANCHORS®

wej-it®
FASTENING SYSTEMS

Call us toll-free: 888-TOGGLER (888-864-4537)

Fax: 203-857-2201 • E-mail: info@toggler.com

www.toggler.com • www.wejit.com

Divisions of Mechanical Plastics Corp.











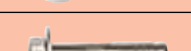

110 Richards Avenue • Norwalk, CT 06854

Mechanical and Adhesive Anchors

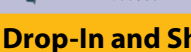
Alphabetical Product Code Listing





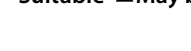











#### Original Wej-It® Wedge Anchors	15	HWLD Hollow Wall Drive Anchor, Long	38
A ALLIGATOR® All-Purpose Flush Mount Anchors	41	HWS Hollow Wall Anchor, Short	38
AF ALLIGATOR All-Purpose Flanged Anchors	41	HWSD Hollow Wall Drive Anchor, Short	38
ASA Sleeve Anchors, Acorn Nut	18	HWXL Hollow Wall Anchor, Extra Long	38
AT Ankr-TITE® Wedge Anchors, Zinc Plated	10	HWXS Hollow Wall Anchor, Extra Short.....	38
ATEZ POWER Screw Bolt™, Zinc Plated	22	LSL Lag Screw Shields, Long	31
ATEZG POWER Screw Bolt, Mechanically Galvanized	22	LSS Lag Screw Shields, Short.....	31
ATG Ankr-TITE Wedge Anchors, Hot-Dip Galvanized.....	10	M Spin-In Chemical Capsules	57
ATS Ankr-TITE Wedge Anchors, 304 Stainless Steel	10	MINI SPM . MINI SnapSkru® Self-Drilling Drywall Anchors.....	39
ATSS Ankr-TITE Wedge Anchors, 316 Stainless Steel.....	10	MS Machine Screw Anchors	31
BA SNAPTOGGLE® 3/16-24 Heavy-Duty Hollow-Wall Anchors ..	35	PD POWER-Drop™ Drop-In Anchors	27
BB SNAPTOGGLE 1/4-20 Heavy-Duty Hollow-Wall Anchors.....	35	PS2 POWER-Sert™ High-Performance Anchors.....	45
BC SNAPTOGGLE 3/8-16 Heavy-Duty Hollow-Wall Anchors.....	35	SDS SDS-plus® Carbide-Tipped Drill Bits	43
BD SNAPTOGGLE 1/2-13 Heavy-Duty Hollow-Wall Anchors.....	35	SDSH SDS Hex For Tapcon®/UltraCon Tools.....	43
BE SNAPTOGGLE 5/16-18 Heavy-Duty Hollow-Wall Anchors.....	35	SDSMHQ .. SDS-max® Cutter Carbide-Tipped Drill Bits	44
CCAT Ankr-TITE CCAT Wedge Anchors Cat. 1 Cracked Concrete.....	7	6SDS SDS Bulk Quality Economy Bits	43
CP Center Pin Anchor	20	SES Single Expansion Shields.....	30
CS Bevel Cut Stud Assm. for Spin-In Chemical Capsules	57	SP SnapSkru® Self-Drilling Anchors	39
CS2 Straight Cut Stud Assm. for Epoxies/Hammer-In Caps.....	47	SPL Standard Spline Carbide-Tipped Drill Bits	44
CS6 Straight Cut Stud Assm. for Epoxies/Hammer-In Caps.....	47	SPM MINI SnapSkru Self-Drilling Drywall Anchors.....	39
CSS Straight Cut Stud Assm. for Epoxies/Hammer-In Caps.....	47	ST Setting Tool for Drop-In Anchors/Mini Drop-In Anchors.....	29
DES Double Expansion Shields	30	T35 TOGLER® Plastic Toggle Anchors: 1-3/8" Grip	32
DN Drive Nail Anchor	21	T39 TOGLER Plastic Toggle Anchors: 1-1/2" Grip.....	32
ECA Inject-TITE™ AWF All-Weather Formula Epoxy Acrylate.....	49	TA ®..... TOGLER Plastic Toggle Anchors: Hollow-Core Door	32
ECANZ Break-Off Mixing Nozzles	47	TAP Taper Bits For Tapcon/UltraCon Tools.....	43
ECT22 Inject-TITE Two-Part Struct. Epoxy Standard-Set Formula...54		TB ®..... TOGLER Plastic Toggle Anchor: Residential Drywall.....	32
ECT22F Inject-TITE Two-Part Struct. Epoxy Fast-Set Formula, 22 oz. ..52		TBM Standard Wing Toggles.....	37
ECT8F Inject-TITE Two-Part Struct. Epoxy Fast-Set Formula, 8.5 oz. ..52		TBS1 TOGLER Specialty Anchors: Shelving.....	34
EHT 10" Dispensing Tools	47	TBS2 TOGLER Specialty Anchors: Pegboard	34
ENZ Break-Off Mixing Nozzles	47	TBW TOGLER Specialty Anchors: Wire Shelf.....	34
ESCN Nylon Screens for Hollow Wall Applications.....	47	TC ®..... TOGLER Plastic Toggle Anchors: Commercial Drywall.....	32
ESCS Stainless Steel Short Screens for Brick and Block	47	TD TOGLER Plastic Toggle Anchors: Double Drywall	32
ESCS Stainless Steel Screens for Brick and Block.....	47	TH ®..... TOGLER Specialty Anchors: Picture Hook	34
FCS UltraCon® Concrete Screws, Phillips Flat Head.....	25	WD Drop-In Anchors/Mini Drop-In Anchors, Steel.....	28
FSA Sleeve Anchors, Flat Head.....	18	WDL Drop-In Anchors/Mini Drop-In Anchors, Lipped Steel.....	28
HCS UltraCon Concrete Screws, Slotted Hex Washer Head.....	25	WDS Drop-In Anchors/Mini Drop-In Anchors, 303 Stainless Stl....28	
HMC Slam-TITE™ Hammer-In Chemical Capsules	55	WDSS Drop-In Anchors/Mini Drop-In Anchors, 316 Stainless Stl. ...28	
HSA Sleeve Anchors, Hex Nut	18	WDU Drop-In Anchors/Mini Drop-In Anchors, Domestic Subs.....	28
HWL Hollow Wall Anchor, Long.....	38	WTW Wej-It Tie Wire WTW Anchor.....	17

Application Guide and Table of Contents

		Page No.	Optimal Application Materials						Code Compliance
			cracked concrete	normal weight concrete	lightweight concrete	hollow masonry	solid masonry	wallboard/ drywall	
Expansion Anchors: Heavy-duty bolts with an expanding clip or sleeve									
	Ankr-TITE [®] CCAT Wedge Anchors for Cracked and Uncracked Concrete	7	▲	▲	▲		▲	Category 1 ICC-ES ESR-2777 Miami-Dade NOA: #09-0319.05 COLA RR 24939	
	Ankr-TITE [®] Wedge Anchors	10		▲	▲		▲	GSA FFS-325 Group II, Type 4, Class 1 Miami-Dade NOA: #08-0911.02	
	Original Wej-It [®] Wedge Anchors	15		▲	▲		▲	GSA FFS-325, Group II, Type 4, Class 1 Former ICC-ES Legacy Report #1821	
	Wej-It [®] Tie Wire (WTW) Anchors	17		▲	▲		▲		
	Sleeve Anchors	18		▲	▲	▲	▲	GSA: FFS-325, Group II, Type 3, Class 3	
Nail Anchors: Combines the ease of hammering with the holding power of an expansion anchor									
	Center Pin Anchors	20		▲	▲		▲	GSA FFS-325 Group II Type 4 Class I	
	Drive Nails	21		▲	▲	▲	▲	GSA FFS-325, Group V, Type 2, Class 2	
Threaded Anchors: Removable and reusable fasteners for concrete and masonry									
	POWER Screw Bolt [™]	22		▲	▲	▲	▲		
	UltraCon [®] Threaded Anchors	25		▲	▲	▲	▲	Miami-Dade NOA: #11-0406.01	
Drop-In and Shield Anchors: Internally-threaded anchors for concrete and masonry applications									
	POWER-Drop [™] Drop-In Anchors	27		▲	▲		▲	Former ICC-ES Legacy Report #5063	
	Drop-In/MINI Drop-In Anchors	28		▲	▲		▲	GSA FFS-325, Group VIII, Type I	
	Single Expansion Shields	30		▲	▲			GSA FF-S-325, Group II, Type 2, Class 2, Style 1	
	Double Expansion Shields	30		▲	▲		▲	GSA FF-S-325, Group II, Type 2, Class 2, Style 2	
	Lag Screw Shields	31		▲	▲	▲	▲	GSA FF-S-325C Group 2, Type 1, Class 1 (long), Class, 2C (short)	
	Machine Screw Anchors	31		▲	▲	▲	▲	A-A 1922A, Type 1 and FF-S-325C, Group 1, Type 1, Class 1	

▲ Suitable Δ May be suitable

Application Guide and Table of Contents

	Page No.	Optimal Application Materials						Code Compliance
		cracked concrete	normal weight concrete	lightweight concrete	hollow masonry	solid masonry	wallboard/ drywall	
Wall Anchors: Secure fixtures in hollow and solid walls								
	TOGGLER® Plastic Toggle Anchors	32	▲	▲	▲	▲	▲	
	TOGGLER® Specialty Anchors	34	▲	▲	▲	▲	▲	
	TOGGLER® SNAPTOGGLE® Heavy-Duty Anchors	35				▲	▲	
	Standard Wing Toggles	37				▲	▲	
	Hollow Wall Anchors	38				▲	▲	
	Hollow Wall Drive Anchors	38				▲	▲	
	TOGGLER® SnapSkru® Self-Drilling Anchors	39					▲	
	TOGGLER® ALLIGATOR® All-Purpose Anchors	41	▲	▲	▲	▲	▲	
SDS Drill Bits for Concrete Applications: Carbide-tipped, high-performance drill bits								
	SDS-plus® Bits	43	N/A	▲	▲	▲	▲	▲
	SDS-max® Cutter and Spline Bits	44	N/A	▲	▲	▲	▲	▲
Adhesive Anchors: Utilize high-strength epoxies and ester-based resins to provide holding power								
	POWER-Sert™ Anchors	45		▲	▲		▲	
	Inject-TITE™ Adhesive Anchors	47		▲	▲	▲	▲	
	Screens, Tools & Straight-Cut Studs	47		▲	▲	▲	▲	
	All-Weather (AWF) Formula Epoxy	49		▲	▲	▲	▲	VOC-Compliant
	Fast-Set Formula Epoxy	52		▲	▲	▲	▲	ICC-ES ESR-2621; NSF/ANSI 61 certified; VOC-Compliant
	Standard-Set Formula Epoxy	54		▲	▲	▲	▲	Miami-Dade NOA: #00-0229.05; NSF/ANSI 61 certified
	Slam-TITE™ Hammer-In Capsules	55		▲	▲		▲	
	Spin-In Capsules & Bevel-Cut Studs	57		▲	▲		▲	

▲ Suitable ▲ May be suitable

Order Form

Copy this page, complete and fax to: 203-857-2201 or e-mail to sales@toggler.com
For questions, contact us at 203-857-2200 ext. 0

Bill To

Account No. _____ Contact Name: _____

Company: _____

Phone No.: _____ Fax No. : _____

E-mail: _____

Address: _____

Ship To

Company: _____ Drop Ship? Y/N _____

Address: _____

Contact name: _____ Phone No.: _____

Order Information

Wej-It / TOGGLER Part No.	No. of Pieces	Description	Price Per Piece	Extended Amount

Total Order Amount: _____

Carrier name: _____

Preferred shipping method: _____

Prepay and Add: _____ Prepaid _____ Collect _____ Account No. _____

Terms:

Net 30: _____ Credit Card: _____

Credit Card No. _____

Exp. Date: _____ Security Code: _____ Billing Zip Code _____

Ankr-TITE® CCAT Wedge Anchors



Specifications, Listings and Approvals

Diameters: 3/8" – 1"

Material:

- Anchor Body: C1035 carbon steel
- Anchor Clip: AISI Type 316 stainless steel
- Washer: ASTM F844
- Nut: ASTM A563 Grade A

Finish: Zinc plated to ASTM B633 with clear chromate added

Federal Specifications: QQZ-325, Type II, Class 3

Code Compliance:

- **ICC-ES Report Number ESR-2777 Category 1: Cracked and Uncracked Concrete**
- 2009, 2006, 2003 and 2000 International Building Codes (IBC)
- 2009, 2006, 2003 and 2000 International Residential Code (IRC)
- 1999 Standard Building Code (SBC)
- 1997 Uniform Building Code (UBC)
- 2007 Florida Building Code (BC & RC)
- Miami-Dade NOA: #09-0319.05
- COLA RR 24939

NOTE: Order Information on following page.

Engineered for Superior Performance in Cracked Concrete

Key Features and Benefits

- Engineered to provide superior performance in cracked concrete in both seismic and wind load conditions
- **Category 1** design criteria ICC-ES Report Number ESR-2777
- **Bolt Size is Hole Size**®
- Safe and reliable expansion mechanism works in both normal and extreme load conditions
- 360° segment contact equalizes load distribution, increasing load-carrying capacity
- Unique **safety shoulder** supports the clip when the anchor is under strain
- Corrosion-resistant **316 stainless steel clip** increases service life and strength
- Dog point prevents damage during installation
- 4-line marking around the length ID stamp eases post-installation inspection
- Proprietary design (US Patent #5,413,441) meets strict acceptance criteria in the 2009, 2006 and 2003 International Building Code for post-installed anchoring applications

Code Compliance:
Category 1
ICC ESR-2777
Miami-Dade
NOA
#09-0319.05
COLA RR 24939

Expansion Anchors



Installation Data[†]

Characteristic	Sym.	Units	Nom. Anchor Dia. (in.)						
			1/2		5/8		3/4		
Outside Diameter	d _o	in.	1/2		5/8		3/4		
Drill Bit Diameter	d	in.	1/2		5/8		3/4		
Installation Torque	T _{inst}	ft-lbf	75		125		225		
Min. Nom. Embedment Depth	h _{nom}	in.	3-1/4	5-1/2	4	6-3/8	4-1/2	7-3/4	
Effective Embedment Depth	h _{ef}	in.	2-3/4	5	3-3/8	5-3/4	3-3/4	7	
Critical Edge Distance	c _{ac}	in.	4-1/8	7-1/2	5	8-5/8	7-1/2	10-1/2	
Min. Edge Distance	c _{min}	in.	5-1/2		5		5-5/8		
Min. Spacing	s _{min}	in.	8-1/4		9-1/4		5-5/8		
Min. Concrete Thickness	h _{min}	in.	6	10	6-3/4	11-1/2	7-1/2	14	
Specified Yield Strength of Anchor Steel	f _{ya}	psi	88,000		83,000		73,000		
Specified Tensile Strength of Anchor Steel	f _{uta}	psi	110,000		104,000		91,000		
Effective Tensile and Shear Stress Area	A _{se}	in ²	0.116		0.144		0.219		

For SI: 1 inch = 25.4 mm, 1 ft-lbf = 1.356 N-m, 1 psi = 6.89 Pa, 1 in² = 645 mm², 1 lb./in. = 0.175 N/mm. †The information presented in this table is to be used in conjunction with the design criteria of ACI 318 Appendix D.

Order Information

Catalog No.	Anchor Size (in.)	Max. Thickness Fastened Material (in.)	Thread Length (in.)	Quantity Box/ Carton
CCAT3830	3/8 x 3	0.525	1-3/4	50/400
CCAT3833	3/8 X 3-3/4	1.275	2-1/2	50/400
CCAT3850	3/8 X 5	2.525	3-1/4	50/400
CCAT1223	1/2 X 2-3/4	0.125	1-1/8	25/200
CCAT1233	1/2 X 3-3/4	0.375	2-5/8	25/200
CCAT1241	1/2 X 4-1/4	0.875	2-5/8	25/200
CCAT1252	1/2 X 5-1/2	2.125	3-3/4	25/150
CCAT1270	1/2 X 7	3.625	4-1/2	25/150
CCAT1282	1/2 X 8-1/2	5.125	5	25/150
CCAT1210	1/2 X 10	6.625	5	25/150
CCAT5832	5/8 X 3-1/2	0.245	1-1/2	10/80
CCAT5841	5/8 X 4-1/4	0.245	2-3/8	10/80
CCAT5850	5/8 X 5	0.87	3-1/8	10/80
CCAT5860	5/8 X 6	1.87	4	10/80
CCAT5870	5/8 X 7	2.87	4-1/2	10/80
CCAT5882	5/8 X 8-1/2	4.37	5	10/40
CCAT5810	5/8 X 10	5.87	5	10/40
CCAT3443	3/4 X 4-3/4	0.55	2-1/4	10/80
CCAT3452	3/4 X 5-1/2	1	3-1/4	10/60
CCAT3461	3/4 X 6-1/4	2.05	3-3/4	10/60
CCAT3470	3/4 X 7	2.8	4-3/4	10/60
CCAT3482	3/4 X 8-1/2	4.3	5	10/40
CCAT3410	3/4 X 10	5.8	5	10/40
CCAT3412	3/4 X 12	7.8	5	5/20
CCAT1060	1 X 6	0.75	3	5/30
CCAT1090	1 X 9	3.75	5	5/20
CCAT1012	1 X 12	6.75	5	5/20

Installation Instructions

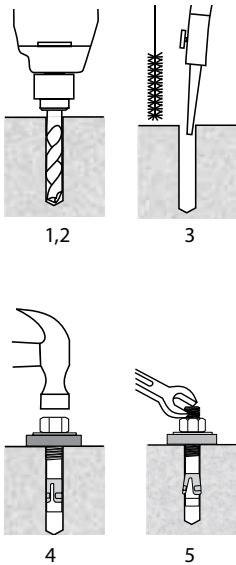

1. Drill the hole, at a diameter equal to the anchor diameter, perpendicular to the work surface. To assure full holding power, do not ream the hole or allow the drill to wobble.
2. Drill the hole deeper than the intended embedment, but not closer than two diameters to the bottom (opposite) surface of the concrete.
3. A clean hole is necessary for proper performance. Clean the hole using a nylon brush and compressed air.
4. Assemble the nut and washer so that the top of the anchor extends above the nut slightly. Install the anchor through the material to be fastened.
5. Installing the Ankr-TITE CCAT anchors with a torque wrench is recommended for optimum performance. Refer to torque recommendations on this page.

NOTE: Always wear safety glasses. Follow drill manufacturer's instructions. Use only solid carbide-tipped drill bits meeting ANSI B212.15 diameter standards.

Allowable Stress Design Values

Anchor Dia. (in.)	h_{nom} Nom. Embedment (in.)	h_{ef} Effective Embedment (in.)	Allowable Tension Load (lb.)
3/8	2-3/8	2	1,050
1/2	3-1/4	2-3/4	2,080
	5-1/2	5	2,246
5/8	4	3-3/8	3,110
	6-3/8	5-3/4	5,593
3/4	4-1/2	3-3/4	3,827
	7-3/4	7	7,294

NOTES:

- For SI: 1 inch = 25.4 mm; 1 lbf = 4.45 N
- Single anchor with static tension only
- Concrete determined to remain uncracked for life of the anchorage
- Load combinations from ACI 318 9.2 (no seismic loading)
- 30% dead load and 70% live load, controlling load combination 1.2D + 1.6L
- Calculation of weighed average:
 $\alpha = 1.2(0.3) + 1.6(0.7) = 1.48$
- $f'_c = 2,500$ psi normal weight concrete
 $C_{a1} = C_{a2} \geq C_{ac} \quad h \geq h_{min}$
- Values are for Condition B (supplementary reinforcement in accordance with ACI 318 D.4.4 is not provided).

Torque Values

Anchor Dia. (in.)	Recommended Setting Torque (ft. lb.)
3/8	20
1/2	75
5/8	125
3/4	225
1	290

Length Identification Codes

Code	Length of Anchor
A	1-1/2 < 2
B	2 < 2-1/2
C	2-1/2 < 3
D	3 < 3-1/2
E	3-1/2 < 4
F	4 < 4-1/2
G	4-1/2 < 5
H	5 < 5-1/2
I	5 1/2 < 6
J	6 < 6-1/2
K	6-1/2 < 7

Code	Length of Anchor
L	7 < 7-1/2
M	7 1/2 < 8
N	8 < 8-1/2
O	8-1/2 < 9
P	9 < 9-1/2
Q	9-1/2 < 10
R	10 < 11
S	11 < 12
T	12 < 13
U	13 < 14
V	14 < 15

Characteristic Shear Strength Design Values

Characteristic	Symbol	Units	Nominal Anchor Diameter (inch)						
			3/8 [†]	1/2	5/8	3/4			
Anchor Category	1, 2, or 3	–	3	1	1	1			
Effective Embedment Depth	h_{ef}	in.	2	2-3/4	5	3-3/8	5-3/4	3-3/4	7
Steel Strength in Shear (ACI 318 D.6.1)^{†††}									
Shear Resistance of Steel	V_{sa}	lbf	3,108	3,599	7,195	7,217	8,986	8,683	11,957
Strength Reduction Factor – Steel Failure	ϕ_{sa}	–	0.6						
Concrete Breakout In Shear (ACI 318 D.6.2)									
Load-bearing Length for Shear	l_e	in.	2	2-3/4	5	3-3/8	5-3/4	3-3/4	7
Nominal Anchor Diameter	$d_a[d_a]^{††}$	in.	3/8	1/2	1/2	5/8	5/8	3/4	3/4
Strength Reduction Factor – Concrete Breakout	ϕ_{cb}	–	0.65	0.7					
Pry-out Strength in Shear									
Coefficient for Pry-out Strength (1.0 for $h_{ef} < 2.5$ in., 2.0 for $h_{ef} > 2.5$ in.)	k_{cp}	–	1	2					
Strength Reduction Factor – Pry-out Failure	ϕ_p	–	0.6	0.7					
Shear Strength for Seismic Applications (ACI 318 D.3.3.3)									
Shear Resistance of Single Anchor for Seismic Loads ($f'_c = 2,500$ psi)	V_{eq}	lbf	–	3,239	6,476	5,055	8,154	8,504	11,957
Strength Reduction Factor – Pull-out Failure	ϕ_{eq}	–	–	0.7					
Shear Strength for Sand-Lightweight and Normal-weight Concrete Over Steel Deck									
Steel Strength in Shear for Concrete Over Steel Deck	$V_{sa, deck}$	lbf	–	3,200	–	3,890	–	–	–
Steel Strength in Shear, Concrete Over Steel Deck, Seismic	$V_{sa, deck, eq}$	lbf	–	2,880	–	2,725	–	–	–
Reduction Factor for Steel Strength in Shear, Concrete Over Steel Deck	ϕ	–	–	0.65					

Characteristic Tension Strength Design Values

Characteristic	Symbol	Units	Nominal Anchor Diameter (in.)						
			3/8 [†]	1/2	5/8	3/4			
Anchor Category	1, 2 or 3	–	3	1	1	1			
Effective Embedment Depth	h_{ef}	in.	2	2-3/4	5	3-3/8	5-3/4	3-3/4	7
Steel Strength in Tension (ACI 318 D.5.1)^{†††}									
Tension Resistance of Steel	N_{sa}	lbf	5,180	12,760	14,980	19,930			
Strength Reduction Factor – Steel Failure	ϕ_{sa}	–	0.65						
Concrete Breakout Strength In Tension (ACI 318 D.5.2)									
Effectiveness Factor – Uncracked Concrete	K_{un-cr}	–	24						
Effectiveness Factor – Cracked Concrete	K_{cr}	–	–	17					
Modification Factor for Cracked and Uncracked Concrete	$\psi_{c,N}^{**}$	–	–	1.00					
Strength Reduction Factor – Concrete Breakout Failure	ϕ_{cb}	–	0.45	0.65					
Pull-Out Strength in Tension (ACI 318 D.5.3)									
Pull-Out Resistance, Uncracked Concrete ($f'_c = 2,500$ psi)	$N_{p, un-cr}$	lbf	N/A*	4,737	5,115	7,082	12,734	N/A*	16,607
Pull-Out Resistance, Cracked Concrete ($f'_c = 2,500$ psi)	$N_{p, cr}$	lbf	–	2,616	3,584	5,144	6,645	N/A*	11,849
Strength Reduction Factor – Pull-out Failure	ϕ_p	0.45	–	0.65					
Tension Strength for Seismic Applications (ACI D.3.3.3)									
Tension Resistance Factor of Single Anchor for Seismic Loads ($f'_c = 2,500$ psi)	$N_{p, eq}$	lbf	–	2,616	3,584	5,144	6,645	N/A*	11,849
Strength Reduction Factor – Pull-out Failure	ϕ_{eq}	–	–	0.65					
Pull-Out Strength in Tension for Concrete Over Steel Deck									
Characteristic Pull-Out Strength, Uncracked Concrete Over Steel Deck	$N_{p, deck un-cr}$	lbf	–	2,475	4,061	–			
Characteristic Pull-Out Strength, Cracked Concrete Over Steel Deck	$N_{p, deck cr}$	lbf	–	1,361	2,965	–			
Reduction Factor for Pull-Out Strength	ϕ	–	–	0.65					

NOTES:

- For SI: 1 inch = 25.4 mm; 1 lbf = 4.45 N
- All values of ϕ apply to the load combinations of IBC Section 1605.2.1, UBC Section 1612.2.1, or ACI 318 Section 9.2. If the load combinations of UBC Section 1902.2 or ACI 318 Appendix C are used, the appropriate value of ϕ must be determined in accordance with ACI 318 D.4.5. For reinforcement that complies with ACI 318 Appendix D requirements for Condition A, the appropriate ϕ factor must be determined in accordance with ACI 318 D.4.4.
- Installation must comply with published instructions and details.
- The information presented in these tables must be used in conjunction with the design criteria of ACI 318 Appendix D; for anchors resisting seismic load combinations the additional requirements of ACI 318 D.3.3 must apply.
- Shear loads for anchors installed through steel deck into concrete may be applied in any direction.

- The nominal pull-out strength in tension can be adjusted in accordance with Section 4.1.4 of ICC-ES ESR-2777.
- † The 3/8" anchor must be limited to uncracked concrete and not used in concrete-filled metal deck applications.
- †† The notation in brackets is for the 2006 IBC.
- ††† The Ankr-TITE anchor is considered a brittle steel element as defined by ACI 318 D.1.
- * Pull-out strength will not control design of indicated anchors.
- ** For all cases, $\psi_{c,N} = 1.0$. The appropriate effectiveness factor for cracked concrete K_{cr} or uncracked concrete K_{un-cr} must be used.

Ankr-TITE® Wedge Anchors

wej-it
FASTENING SYSTEMS

Code Compliance:
Miami-Dade
NOA
#08-0911.02



Features unique safety shoulder and clip combination

Key Features and Benefits

- Bolt Size is Hole Size®
- Available in four combinations:
 1. Zinc plated carbon steel with steel clip
 2. Hot-dip galvanized carbon steel with 304 stainless steel clip
 3. All 304 stainless steel
 4. All 316 stainless steel
- Sets up fast
 - Needs less rotation to achieve required torque
- Unique “**safety shoulder**”
 - Supports clip when anchor is under strain
 - Minimizes bolt-end collapse and/or clip slippage under ultimate loading conditions
- Enlarged dimples on clip
 - Reduce slip
 - Increase response in lighter concrete
- 360° segment contact on clip equalizes load distribution
 - Increases load-carrying capacity
 - More adaptable to/“forgiving” in different installation conditions

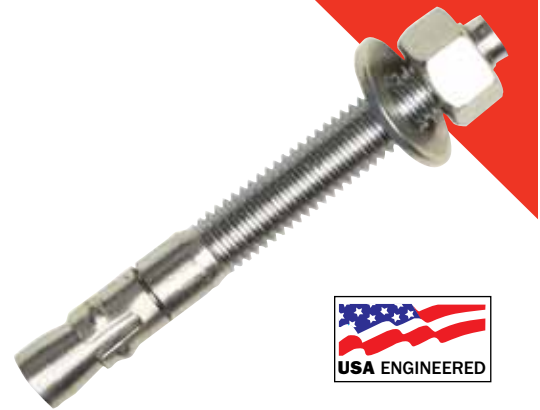

Specifications, Listings and Approvals

Diameters: 1/4" – 1-1/4"

Body

- Carbon Steel: UNS G 10350, AISI 1035
- Stainless: AISI 12L14 Type 304 or Type 316

Finish

- Zinc: ASTM B633 Type III, SC1
- Hot-dip galvanized: ASTM A153; B454; B695-82 and MIL-C-81562A

Clip

- Carbon steel: ASTM A108 Grade 1018
- Stainless steel: Type 304 or Type 316

Washer

- Carbon steel: ANSI/ASME B18.22.1 zinc coated
- Stainless steel: Type 304 or Type 316

Nut

- Carbon steel: ANSI/ASME B18.2.2 zinc coated
- Stainless steel: Type 304 or Type 316

Federal Specifications

- QQZ-325Z, Type II, Class 3
- GSA FFS-325 Group II, Type 4, Class 1 (Clear Chromate Added)
- GSA FFS-325 Group II, Type 4, Class 1

Code Compliance

- Miami/Dade NOA: No. 08-0911.02
- State DOT Approvals: Call Customer Service for specific information by state

Order Information†

Carbon Steel Catalog No.		Stainless Steel Catalog No.		Anchor Size (in.)	Min. Embed. (in.)	Thread Length (in.)	Quantity Box /Carton
Zinc Plated	Galvanized	Type 304	Type 316				
AT1413	ATG1413	ATS1413	ATSS1413*	1/4 x 1-3/4	1-1/4	3/4	100/800
AT1421	ATG1421	ATS1421	ATSS1421	1/4 x 2-1/4	1-1/4	1-1/4	100/800
AT1431	ATG1431	ATS1431	ATSS1431	1/4 x 3-1/4	1-1/4	2-1/4	100/800
AT3821	ATG3821	ATS3821	ATSS3821	3/8 x 2-1/4	1-3/4	1	50/400
AT3823	ATG3823	ATS3823	ATSS3823	3/8 x 2-3/4	1-3/4	1-1/2	50/400
AT3830	ATG3830	ATS3830	ATSS3830	3/8 x 3	1-3/4	1-3/4	50/400
AT3833	ATG3833	ATS3833	ATSS3833	3/8 x 3-3/4	1-3/4	2-1/2	50/400
AT3850	ATG3850	ATS3850	ATSS3850	3/8 x 5	1-3/4	3-1/4	50/400
AT3870	ATG3870	ATS3870	ATSS3870	3/8 x 7	1-3/4	4-1/2	50/300
AT1223	ATG1223	ATS1223	ATSS1223	1/2 x 2-3/4	2-1/8	1-1/8	25/200
AT1233	ATG1233	ATS1233	ATSS1233	1/2 x 3-3/4	2-1/8	2-1/8	25/200
AT1241	ATG1241	ATS1241	ATSS1241	1/2 x 4-1/4	2-1/8	2-5/8	25/200
AT1242	ATG1242*	ATS1242*	ATSS1242*	1/2 x 4-1/2	2-1/8	2-5/8	25/200
AT1252	ATG1252	ATS1252	ATSS1252	1/2 x 5-1/2	2-1/8	3-3/4	25/150
AT1270	ATG1270	ATS1270	ATSS1270	1/2 x 7	2-1/8	4-1/2	25/150
AT1282	ATG1282	ATS1282*	ATSS1282*	1/2 x 8-1/2	2-1/8	5	10/40
AT1210	ATG1210	ATS1210*	ATSS1210*	1/2 x 10	2-1/8	5	10/40
AT5832	ATG5832	ATS5832	ATSS5832	5/8 x 3-1/2	2-5/8	1-1/2	10/80
AT5841	ATG5841	ATS5841	ATSS5841	5/8 x 4-1/4	2-5/8	2-3/8	10/80
AT5850	ATG5850	ATS5850	ATSS5850	5/8 x 5	2-5/8	3-1/8	10/80
AT5860	ATG5860	ATS5860	ATSS5860	5/8 x 6	2-5/8	4	10/80
AT5870	ATG5870	ATS5870	ATSS5870	5/8 x 7	2-5/8	4-1/2	10/80
AT5882	ATG5882	ATS5882	ATSS5882	5/8 x 8-1/2	2-5/8	5	10/40
AT5810	ATG5810	ATS5810	ATSS5810*	5/8 x 10	2-5/8	5	10/40
AT5812	ATG5812	ATS5812*	ATSS5812*	5/8 x 12	2-5/8	5	10/40
AT3441	ATG3441	ATS3441	ATSS3441*	3/4 x 4-1/4	3-1/4	2	10/80
AT3443	ATG3443	ATS3443	ATSS3443	3/4 x 4-3/4	3-1/4	2-1/2	10/80
AT3452	ATG3452	ATS3452	ATSS3452	3/4 x 5-1/2	3-1/4	3-1/4	10/60
AT3461	ATG3461	ATS3461	ATSS3461	3/4 x 6-1/4	3-1/4	3-3/4	10/60
AT3470	ATG3470	ATS3470	ATSS3470	3/4 x 7	3-1/4	4-3/4	10/60
AT3482	ATG3482	ATS3482	ATSS3482	3/4 x 8-1/2	3-1/4	5	10/40
AT3410	ATG3410	ATS3410	ATSS3410*	3/4 x 10	3-1/4	5	10/40
AT3412	ATG3412	ATS3412	ATSS3412*	3/4 x 12	3-1/4	5	4/16
AT7860	ATG7860	ATS7860*	ATSS7860*	7/8 x 6	3-7/8	3-1/2	4/24
AT7880	ATG7880	ATS7880*	ATSS7880*	7/8 x 8	3-7/8	5	4/16
AT7810	ATG7810	ATS7810*	ATSS7810*	7/8 x 10	3-7/8	5	4/16
AT1060	ATG1060	ATS1060	ATSS1060*	1 x 6	4	3	4/24
AT1090	ATG1090	ATS1090	ATSS1090*	1 x 9	4	5	4/16
AT1012	ATG1012	ATS1012	ATSS1012*	1 x 12	4	5	4/16
AT11490*	ATG11490 ¹	ATS11490*	ATSS11490*	1-1/4 x 9	5-5/8	5	4/16
AT11412*	ATG11412 ¹	ATS11412*	ATSS11412*	1-1/4 x 12	5-5/8	5	4/16

† Call for pallet pricing

* Special order items: please contact Customer Service, extension 101

1. ATG11490 and ATG11412 have a steel clip instead of a stainless steel clip

Installation Instructions

1. Drill the hole, whose diameter equals the anchor diameter, perpendicular to the work surface. To assure full holding power, do not ream the hole or allow the drill to wobble.
2. Drill the hole deeper than the intended embedment, but not closer than two diameters to the opposite surface of the concrete.
3. A clean hole is necessary for proper performance. Clean the hole using a nylon brush and compressed air.
4. Assemble the nut and washer so that the top of the nut is flush with the top of the anchor. Drive the anchor through the material to be fastened so that the nut and washer are flush with the surface of the material.
5. Tighten the nut, or head, 3 to 5 turns past the hand tight position. Installing the "Ankr-TITE® Series" of anchors with a torque wrench is recommended for optimum performance. Refer to adjacent chart.*

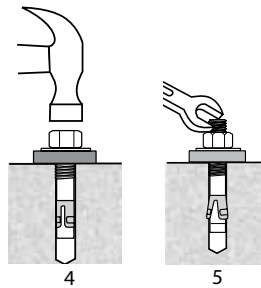
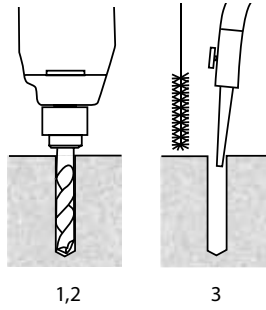

NOTE: Always wear safety glasses. Follow drill manufacturer's instructions. Use only solid carbide-tipped drill bits meeting ANSI B212.15 diameter standards.

Edge Distance

Embedment (E) in Anchor Diameters	Edge Distance
$E < 6d$ (shallow)	1.75E
$6d \leq E \leq 8d$ (standard)	1.00E
$8d < E$ (deep)	0.75E

*Torque Values

Anchor Dia. (in.)	Recommended Setting Torque (ft lb.)		W/O Inspection Turns To Set
	for Zinc & Galvanized	Stainless Steel	
1/4	6-8	4-7	3-5
3/8	20-25	20-25	3-5
1/2	50-55	40-50	3-5
5/8	90-95	80-90	3-5
3/4	165-175	145-155	3-5
7/8	240-250	N/A	3-5
1	290-300	250-275	3-5

Recommended Edge Distance & Spacing

Anchor Diameter (in.)	Embedment Depth (in.)	Edge Distance Requirements (in.)
1/4	1-1/4	2-1/4
	2-7/8	2-1/8
3/8	1-3/4	3-1/8
	4-5/8	3-1/2
1/2	2-1/8	3-3/4
	2-1/2	4-3/8
	6-1/4	4-1/2
5/8	2-5/8	4-1/2
	3-1/4	5-1/2
	6-1/4	4-1/2
3/4	3-1/4	5-1/2
	3-3/4	6-1/2
	7-7/8	6
7/8	3-7/8	6-3/4
	8-5/8	6-1/2
1	4	7
	10-1/2	7-7/8

Load Adjustment Factor For Anchor Spacing

Spacing Tension ^FAN (all dimensions in inches)

Anchor Dia. 1/4			Anchor Dia. 3/8			Anchor Dia. 1/2			Anchor Dia. 5/8			Anchor Dia. 3/4		
Embed. Depth	1-1/4	2-1/2	Embed. Depth	1-3/4	4-5/8	Embed. Depth	2-1/8	6-1/4	Embed. Depth	2-3/4	6	Embed. Depth	3-3/4	7-7/8
1-1/8			1	0.50		1			3			2		
1-1/4	0.65	0.70	1-1/4	0.65	0.7	1-1/4	0.60	0.70	2-1/4	0.65	0.75	2-1/4		
1-1/2	0.75	0.75	1-1/2	0.70	0.75	1-1/2	0.70	0.75	2-1/2	0.77	0.76	2-1/2		
1-3/4	0.78	0.79	1-3/4	0.73	0.79	2-1/4	0.83	0.78	2-3/4	0.95	0.78	3	0.60	
2	0.86	0.84	2	0.76	0.80	2-1/2	0.85	0.79	3-1/2	0.93	0.80	4	0.75	0.75
2-1/4	0.87	0.85	2-1/2	0.77	0.83	3	0.90	0.80	4	0.95	0.83	5	0.80	0.80
2-1/2	0.99	0.86	3	1.00	0.87	3-3/8	0.93	0.87	4-1/2	0.96	0.86	5-3/4	0.87	0.83
3	1.00	0.87	3	0.80	0.85	3-3/4	0.99	0.90	5-1/2	0.99	0.93	6-1/4	0.90	0.85
3-3/8		0.88	3-1/2	0.90	0.90	4-1/4	1.00	0.93	6	1.00	0.96	7	1.00	0.90
3-1/2		0.89	3-3/4	1.00	0.93	4-3/4		0.96	7		1.00	8		0.96
3-3/4		1.00	4		0.95	5		0.98				9		0.98
			4-1/2		0.98	6		0.99				10		1.00
			4-5/8		1.00	7		1.00						

Length Selection

- Minimum Embedment (A)
 - + Attached Material Thickness (B)
 - + Nut Height* (C)
 - = Total Anchor Length (D)
- *Nut height equals anchor diameter.

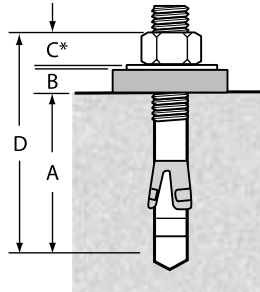

Length Identification Codes

Code	Length of Anchor	Code	Length of Anchor	Code	Length of Anchor
A	1-1/2 < 2	J	6 < 6-1/2	S	11 < 12
B	2 < 2-1/2	K	6-1/2 < 7	T	12 < 13
C	2-1/2 < 3	L	7 < 7-1/2	U	13 < 14
D	3 < 3-1/2	M	7-1/2 < 8	V	14 < 15
E	3-1/2 < 4	N	8 < 8-1/2	W	15 < 16
F	4 < 4-1/2	O	8-1/2 < 9	X	16 < 17
G	4-1/2 < 5	P	9 < 9-1/2	Y	17 < 18
H	5 < 5-1/2	Q	9-1/2 < 10	Z	18 < 19
I	5-1/2 < 6	R	10 < 11		

**Maximum Tensile Capacity For Static Loads
All Anchor Materials**

Anchor & Hole Size	4000 psi Concrete			6000 psi Concrete		
	Embed. (in.)	Tension (lb.)	Shear (lb.)	Embed. (in.)	Tension (lb.)	Shear (lb.)
1/4	1-1/4	2000	2811	1-1/4	2042	2811
	2-1/2	2600	2811	2-1/2	2826	2811
3/8	1-3/4	3850	3075	1-3/4	4790	3075
	4-5/8	6020	4227	4-5/8	6635	4227
1/2	2-1/8	6324	6260	2-1/8	7540	6260
	6-1/4	8249	7516	6-1/4	10713	7516
5/8	2-5/8	9527	9760	2-5/8	10597	9760
	6	15893	11743	6	16705	11743
3/4	3-3/4	13130	15860	3-3/4	18979	15860
	7-7/8	19795	23817	7-7/8	24145	23817
7/8	4	16591	24000	4	19945	24000
	8	27484	25710	8	33113	25710
1	5	26676	32494	5	30683	32494
	9	36171	36896	9	36171	36896
1-1/4	5-5/8	28733	46975	5-5/8	28733	46975
	10	50390	46975	10	50390	46975

**Allowable Tensile Capacity For Static Loads
All Anchor Materials**

Anchor & Hole Size	4000 psi Concrete			6000 psi Concrete		
	Embed. (in.)	Tension (lb.)	Shear (lb.)	Embed. (in.)	Tension (lb.)	Shear (lb.)
1/4	1-1/4	500	703	1-1/4	511	703
	2-1/2	650	703	2-1/2	707	703
3/8	1-3/4	963	769	1-3/4	1198	769
	4-5/8	1505	1057	4-5/8	1659	1057
1/2	2-1/8	1581	1565	2-1/8	1885	1565
	6-1/4	2062	1879	6-1/4	2678	1879
5/8	2-5/8	2382	2440	2-5/8	2649	2440
	6	3973	2936	6	4176	2936
3/4	3-3/4	3283	3965	3-3/4	4745	3965
	7-7/8	4949	5920	7-7/8	6036	5954
7/8	4	4148	6000	4	4986	6000
	8	6871	6428	8	8278	6428
1	5	6669	8124	5	7670	8124
	9	9043	9224	9	9043	9224
1-1/4	5-5/8	7183	11744	5-5/8	7183	11744
	10	12598	11744	10	12598	11744

Ultimate Tension and Shear

Anchor Dia. (in.)	Install. Torque	Embed. Depth (in.)	Lower Flute of Steel Deck with Lightweight Concrete Fill* f'c = 3,000 PSI	
			Tension (lb.)	Shear (lb.)
3/8	20-25	1-3/4	2414	4054
		3	3169	
1/2	50-55	2-1/2	3458	5038
		4	4274	
5/8	90-95	3-1/4	4199	5884
		5	5036	
3/4	110-120	3-3/4	5136	8030
		5-1/2	7711	

Concrete-filled Steel Deck

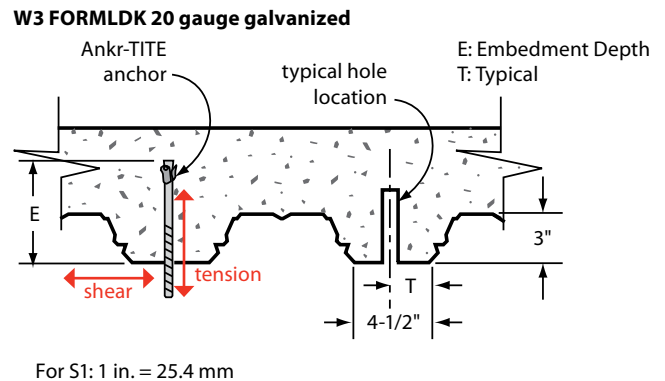

• Information provided only for the use of a qualified design engineer. Use of technical data by unqualified persons could cause serious damage, injury, or even death.

NOTES:

- For static loads, use one-fourth of the maximum tensile and shear capacities for the recommended 4:1 safety factor.
- Tested to ASTM E488 Test Standard. Sources (available upon request): U.S. Testing Co., Tulsa, OK, Stork, Minneapolis, MN

ALLOWABLE Tension Capacity for Static Load: 4K & 6K psi Concrete, 4-1 Safety Factor

PSI	Dia. (in.)	Embedment (in.)																				
		1-3/4	2	2-1/4	2-1/2	2-3/4	3	3-1/4	3-1/2	3-3/4	4	4-1/4	4-1/2	4-5/8								
4K	3/8	963	1010	1057	1104	1151	1198	1246	1289	1340	1387	1434	1481	1505								
6K		1198	1238	1278	1318	1358	1398	1438	1478	1518	1559	1599	1639	1659								
		2-1/8	2-1/2	2-3/4	3	3-1/4	3-1/2	3-3/4	4	4-1/4	4-1/2	4-3/4	5	5-1/4	5-1/2	5-3/4	6	6-1/4				
4K	1/2	1581	1625	1654	1683	1712	1742	1771	1800	1829	1858	1887	1917	1946	1975	2004	2033	2062				
6K		1885	1957	2005	2053	2101	2150	2198	2246	2294	2342	2390	2438	2486	2534	2582	2630	2678				
		2-5/8	2-3/4	3	3-1/4	3-1/2	3-3/4	4	4-1/4	4-1/2	4-3/4	5	5-1/4	5-1/2	5-3/4	6						
4K	5/8	2382	2441	2559	2677	2794	2912	3030	3148	3266	3384	3502	3620	3738	3855	3973						
6K		2649	2701	2819	2932	3045	3158	3271	3386	3498	3611	3724	3837	3950	4063	4176						
		3-3/4	4	4-1/4	4-1/2	4-3/4	5	5-1/4	5-1/2	5-3/4	6	6-1/4	6-1/2	6-3/4	7	7-1/4	7-1/2	7-3/4	7-7/8			
4K	3/4	3283	3384	3485	3586	3687	3788	3889	3990	4091	4192	4292	4393	4494	4595	4696	4797	4898	4949			
6K		4745	4823	4901	4980	5058	5136	5215	5293	5371	5449	5528	5606	5684	5762	5841	5919	5997	6036			
		4	4-1/4	4-1/2	4-3/4	5	5-1/4	5-1/2	5-3/4	6	6-1/4	6-1/2	6-3/4	7	7-1/4	7-1/2	7-3/4	8				
4K	7/8	4148	4318	4488	4658	4828	4999	5169	5339	5510	5680	5850	6020	6190	6361	6531	6701	6871				
6K		4986	5192	5398	5603	5809	6015	6221	6427	6633	6838	7044	7250	7455	7661	7867	8073	8278				
		5	5-1/4	5-1/2	5-3/4	6	6-1/4	6-1/2	6-3/4	7	7-1/4	7-1/2	7-3/4	8	8 1/4	8-1/2	8-3/4	9				
4K	1	6669	6820	6921	7116	7263	7411	7559	7708	7856	8004	8153	8301	8449	8598	8746	8895	9043				
6K		7671	7757	7842	7929	8014	8100	8185	8271	8357	8443	8528	8614	8700	8786	8871	8958	9043				
		5-5/8	5-3/4	6	6-1/4	6-1/2	6-3/4	7	7-1/4	7-1/2	7-3/4	8	8-1/4	8-1/2	8-3/4	9	9-1/4	9-1/2	9-3/4	10		
4K	1-1/4	7183	7338	7647	7957	8266	8576	8885	9194	9504	9813	10123	10432	10741	11051	11360	11669	11979	12288	12598		

MAXIMUM Tension Capacity for Static Loads: 4K & 6K psi Concrete

PSI	Dia. (in.)	Embedment (in.)																				
		1-3/4	2	2-1/4	2-1/2	2-3/4	3	3-1/4	3-1/2	3-3/4	4	4-1/4	4-1/2	4-5/8								
4K	3/8	3850	4039	4227	4416	4605	4793	4982	5157	5360	5548	5737	5926	6020								
6K		4790	4950	5111	5271	5432	5592	5753	5913	6073	6234	6394	6555	6635								
		2-1/8	2-1/2	2-3/4	3	3-1/4	3-1/2	3-3/4	4	4-1/4	4-1/2	4-3/4	5	5-1/4	5-1/2	5-3/4	6	6-1/4				
4K	1/2	6324	6499	6616	6732	6849	6966	7082	7199	7316	7532	7549	7666	7782	7899	8016	8132	8249				
6K		7540	7828	8021	8213	8405	8598	8790	8982	9175	9367	9559	9751	9944	10136	10328	10521	10713				
		2-5/8	2-3/4	3	3-1/4	3-1/2	3-3/4	4	4-1/4	4-1/2	4-3/4	5	5-1/4	5-1/2	5-3/4	6						
4K	5/8	9527	9763	10234	10706	11177	11649	12121	12592	13064	13535	14007	14478	14950	15421	15893						
6K		10597	10803	11276	11728	12181	12633	13085	13538	13990	14443	14895	15348	15800	16253	16705						
		3-3/4	4	4-1/4	4-1/2	4-3/4	5	5-1/4	5-1/2	5-3/4	6	6-1/4	6-1/2	6-3/4	7	7-1/4	7-1/2	7-3/4	7-7/8			
4K	3/4	13130	13534	13938	14342	14746	15150	15554	15958	16362	16765	17169	17573	17977	18381	18785	19189	19593	19795			
6K		18979	19292	19605	19918	20231	20544	20858	21171	21484	21797	22110	22423	22736	23049	23362	23675	23988	24145			
		4	4-1/4	4-1/2	4-3/4	5	5-1/4	5-1/2	5-3/4	6	6-1/4	6-1/2	6-3/4	7	7-1/4	7-1/2	7-3/4	8				
4K	7/8	16591	17272	17953	18633	19314	19995	20676	21357	22038	22718	23399	24080	24761	25442	26122	26803	27484				
6K		19945	20768	21591	22414	23237	24060	24883	25706	26529	27352	28175	28998	29821	30644	31467	32290	33113				
		5	5-1/4	5-1/2	5-3/4	6	6-1/4	6-1/2	6-3/4	7	7-1/4	7-1/2	7-3/4	8	8-1/4	8-1/2	8-3/4	9				
4K	1	26676	27279	27863	28465	29050	29643	30237	30830	31424	32017	32610	33204	33797	34391	34984	35578	36171				
6K		30683	31026	31369	31712	32055	32398	32741	33084	33427	33770	34113	34456	34799	35142	35485	35828	36171				
		5-5/8	5-3/4	6	6-1/4	6-1/2	6-3/4	7	7-1/4	7-1/2	7-3/4	8	8-1/4	8-1/2	8-3/4	9	9-1/4	9-1/2	9-3/4	10		
4K	1-1/4	28733	29352	30589	31827	33064	34302	35539	36777	38015	39252	40490	41727	42965	44202	45440	46677	47915	49152	50390		



Specifications, Listings and Approvals

Diameters: 1/4" – 1"

Material: Carbon steel

Finish: Zinc plating ASTM B633, Type III, SC1

Federal Specifications:

- QQZ-325C, Type II, Class 3 (clear chromate added)
- GSA FFS-325, Group II, Type 4, Class 1

Code Compliance:

- Formerly ICC-ES Legacy Report #1821
- 1997 Uniform Building Code (UBC)
- 2000 International Building Code (IBC)
- 2000 International Residents Code
- Data Test in accordance with the ICC-ES criteria for Expansion Anchors in Concrete and Masonry Elements (ACOI) dated April 2002. Available upon request.
- State DOT: Please call Customer Service for specific approval information by state

60 years of proven performance

Key Features and Benefits

- Time-tested, proven reliability
 - An industry standard for over 60 years
- Fully assembled and ready to use
- Unparalleled job-site convenience
 - No fixture-moving required
- **Bolt Size is Hole Size®** eases installation
 - Allows precision placement of equipment through pre-drilled holes
- Exclusive **"positive wedge connections"**
 - Minimizes wedge loosening due to vibratory loads

Code Compliance:
Formerly ICC-ES Legacy Report #1821

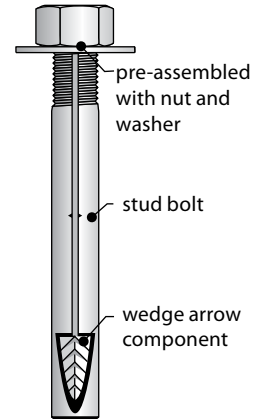

Expansion Anchors

Length Selection

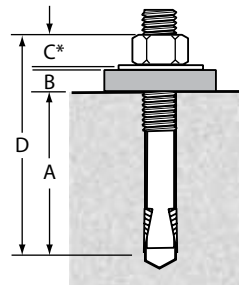

Minimum Embedment (A)
 + Attached Material Thickness (B)
 + Nut Height* (C)
 = Total Anchor Length (D)
 *Nut height equals anchor diameter.

Order Information

Catalog Number	Anchor Size (in.)	Min. Embedment (in.)	Thread Length (in.)	Quantity Box /Carton
1413	1/4 x 1-3/4	1	1/2	100/600
1423	1/4 x 2-3/4	1	1/2	100/600
1430	1/4 x 3	1	1/2	100/600
5620	5/16 x 2	1-1/4	5/8	100/600
5630	5/16 x 3	1-1/4	5/8	100/600
3820	3/8 x 2	1-1/2	3/4	100/600
3823	3/8 x 2-3/4	1-1/2	3/4	100/600
3832	3/8 x 3-1/2	1-1/2	3/4	50/300
3850	3/8 x 5	1-1/2	3/4	50/300
3860	3/8 x 6	1-1/2	3/4	50/300
1223	1/2 x 2-3/4	2	1	50/300
1232	1/2 x 3-1/2	2	1	50/300
1250	1/2 x 5	2	1	25/150
1260	1/2 x 6	2	1	25/150
1270	1/2 x 7	2	1	25/150
5832	5/8 x 3-1/2	3	1-1/4	25/150
5842	5/8 x 4-1/2	3	1-1/4	25/150

Order information continued on following page

Order Information, continued

Catalog Number	Anchor Size (in.)	Min. Embedment (in.)	Thread Length (in.)	Quantity Box /Carton
5850	5/8 x 5	3	1-1/4	20/120
5860	5/8 x 6	3	1-1/4	15/90
5870	5/8 x 7	3	1-1/4	15/90
3440	3/4 x 4	3	1-1/2	18/108
3450	3/4 x 5	3	1-1/2	12/72
3460	3/4 x 6	3	1-1/2	12/72
3470	3/4 x 7	3	1-1/2	10/60
3482	3/4 x 8-1/2	3	1-1/2	10/30
3410	3/4 x 10	3	1-1/2	10/30
7880	7/8 x 8	4-1/2	1-3/4	10/30
7810	7/8 x 10	4-1/2	1-3/4	10/30
7812	7/8 x 12	4-1/2	1-3/4	5/15
1080	1 x 8	5-1/2	2	10/30
1010	1 x 10	5-1/2	2	5/15
1012	1 x 12	5-1/2	2	5/15

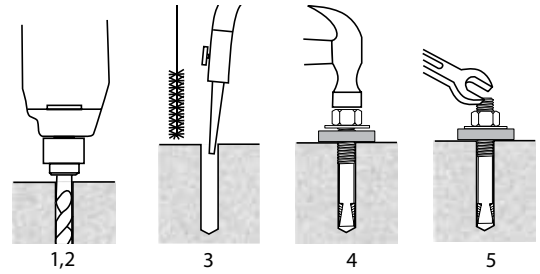

Installation Instructions

1. Drill the hole perpendicular to the work surface with a solid carbide bit that meets ANSI B212.5 specifications. The drill bit diameter will be the same as the anchor diameter that you are installing. To assure full holding power, do not ream the hole or allow the drill to wobble.
2. Drill the hole one diameter deeper than the intended embedment of the anchor, but not closer than two diameters to the bottom (opposite) surface of the concrete.
3. Clean the hole using compressed air and a nylon brush. A clean hole is necessary for proper performance.
4. Insert anchor into hole until washer rests solidly against fixture.
5. Tighten 1-1/2 to 3 turns past hand tight position but to a maximum torque as listed in the table below.

NOTE: Always wear safety glasses. Follow drill manufacturer's instructions. Use only solid carbide-tipped drill bits meeting ANSI B212.15 diameter standards.

Edge Distance & Spacing Requirements

Embedment (E) in Anchor Diameters	Spacing	Edge Distance
$E < 6d$ (shallow)	3.5E	1.75E
$6d \leq E \leq 8d$ (standard)	2.00E	1.00E
$8d < E$ (deep)	1.50E	0.75E

Recommended Edge Distance & Spacing

Anchor Diameter (in.)	Embedment Depth	Edge Distance Requirements	Spacing Requirements
1/4	1-1/8	1-31/32	3-15/16
	1-1/2	2-5/8	5-1/4
5/16	1-1/4	2-3/16	4-3/8
	1-3/4	3-1/16	6-1/8
3/8	1-1/2	2-5/8	5-1/4
	4	3	6
1/2	2-1/4	3-15/16	7-7/8
	5	3-3/4	7-1/2
5/8	3-1/2	6-1/8	12-1/4
	4-3/4	8-5/16	16-5/8
3/4	3	5-1/4	10-1/2
	7	5-1/4	10-1/2
7/8	4-1/2	7-7/8	15-3/4
	7	7	14
1	5-1/2	9-5/8	19-1/4
	7	7	14

Torque Values

Anchor Dia. (in.)	Recommended Setting Torque (ft lb.)	Recommended Minimum Embedment (in.)
1/4	8	1
5/16	15	1-1/4
3/8	25	1-1/2
1/2	55	2
5/8	95	3
3/4	170	3
7/8	250	4-1/2
1	300	5-1/2

Maximum Tensile and Shear Capacity For Static Loads

Anchor & Hole Size	Limestone Aggregate			Unreinforced Stone Aggregate Concrete							Unreinforced Lightweight (Idealite)		
	Embed. (in.)	2000 psi		Embed. (in.)	3000 psi		5000 psi		7000 psi		Embed. (in.)	5000 psi	
		Tension (lb.)	Shear (lb.)		Tension (lb.)	Shear (lb.)	Tension (lb.)	Shear (lb.)	Tension (lb.)	Shear (lb.)		Tension (lb.)	Shear (lb.)
1/4	1-1/8	1132	1211	1-1/8	1320	1751	1760	2316	2464	2494	1-1/2	1861	1947
1/4	1-3/4	1256	1211	1-1/2	1856	1751	2473	2316	3462	2494	-	-	-
5/16	1-1/4	1308	1210	1-1/4	2057	1839	2742	2530	3939	3439	1-1/2	2493	3064
5/16	2	1181	1210	1-3/4	2389	1839	3185	2530	4459	3439	-	-	-
3/8	1-1/4	994	1223	1-1/2	2876	4286	3834	5213	5368	5658	1-3/4	3125	4289
3/8	4	1728	1223	4	3488	4286	4650	5213	6510	5658	-	-	-
1/2	1-3/4	1542	3009	2-1/4	3473	7138	5789	10748	8105	11550	2-1/4	4778	9833
1/2	6	2695	3009	5	4809	7138	8015	10748	11221	11550	-	-	-
5/8	-	-	-	3-1/2	7582	10719	12636	15583	17690	16700	2-1/2	6455	12500
5/8	-	-	-	4-3/4	9179	10719	15299	15583	21419	16700	-	-	-
3/4	-	-	-	3	11579	15537	19299	21000	27019	23103	3-1/2	17293	19050
3/4	-	-	-	7	15444	15537	25740	21000	36036	23103	-	-	-
7/8	-	-	-	4-1/2	15266	-	25444	25099	33622	28718	-	-	-
7/8	-	-	-	7	16992	-	28320	25099	39648	28718	-	-	-
1	-	-	-	5-1/2	16351	-	27252	33083	38153	35700	4-1/2	21616	31666
1	-	-	-	7	17837	-	29728	33083	41619	35700	-	-	-
Source	1			2							2		

Sources (available upon request):

1. University of Texas, Austin, TX (using ICBO-ES testing criteria); 1993.
2. AA Engineers & Associates, Inc., Denver, CO; 1981.

NOTES:

- Information provided only for the use of a qualified design engineer. Use of technical data by persons not qualified could cause serious damage, injury, or even death.
- Ultimate values shown. For static loads, use one-fourth of the maximum tensile and shear capacities for the recommended 4:1 safety factor.
- Tested to ASTM E488 Test Standard
- Sources (available upon request): U.S. Testing Co., Tulsa, OK



Wej-It Tie Wire WTW Anchor

- For bracing and hanging acoustical ceiling tile, hanging electrical lights or other lightweight applications

Order Information

Catalog Number	Anchor Dia. & Length (in.)	Min. Embedment (in.)	Eye Diameter	Quantity: Cards Per Box/Carton
WTW1421	1/4 x 2 1/4	1 1/4	9/32	100/1000

Edge Distance

Embedment (E) in Anchor Diameters	Edge Distance
$E < 6d$ (shallow)	1.75E
$6d \leq E \leq 8d$ (standard)	1.00E
$8d < E$ (deep)	0.75E

Sleeve Anchors

Expansion Anchors

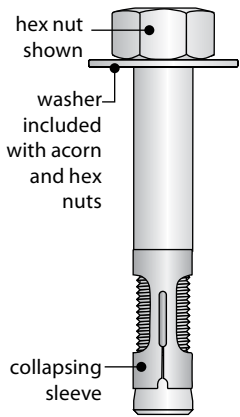

For a wide variety of masonry applications

Key Features/Benefits

- Fully assembled and ready to use
 - Speeds installation
 - Eliminates the problem of missing components
- Suitable for a wide variety of applications
- Available with acorn or hex nut, or with slotted flat head



Available Nut and Head Styles

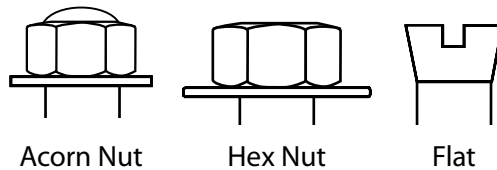

Length Selection

$$\begin{aligned}
 & \text{Minimum Embedment (A)} \\
 + & \text{ Attached Material Thickness (B)} \\
 + & \text{ Nut Height* (C)} \\
 = & \text{ Total Anchor Length (D)}
 \end{aligned}$$

*Nut height equals anchor diameter.

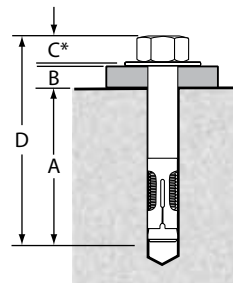

Order Information

Catalog Number		Head or Nut Style	Anchor Size (in.)	Drill Bit Size (in.)	Min. Embed. (in.)	Qty. Box/ Carton
Carbon Steel	Stainless Steel					
ASA1413	ASAX1413	Acorn Nut	1/4 x 1-3/8	1/4	1-1/8	100/1000
ASA1421		Acorn Nut	1/4 x 2-1/4	1/4	1-1/8	100/800
HSA5612	HSAX5612	Hex Nut	5/16 x 1-1/2	5/16	1-1/4	100/800
HSA5622	HSAX5622	Hex Nut	5/16 x 2-1/2	5/16	1-1/4	100/800
HSA3813	HSAX3813	Hex Nut	3/8 x 1-7/8	3/8	1-1/2	50/400
HSA3830	HSAX3830	Hex Nut	3/8 x 3	3/8	1-1/2	50/400
HSA1221	HSAX1221	Hex Nut	1/2 x 2-1/4	1/2	1-7/8	25/200
HSA1230	HSAX1230	Hex Nut	1/2 x 3	1/2	1-7/8	25/200
HSA1240	HSAX1240	Hex Nut	1/2 x 4	1/2	1-7/8	25/200
HSA1260		Hex Nut	1/2 x 6	1/2	1-7/8	25/200
HSA5821		Hex Nut	5/8 x 2-1/4	5/8	2	25/200
HSA5830		Hex Nut	5/8 x 3	5/8	2	25/200
HSA5841	HSAX5841	Hex Nut	5/8 x 4-1/4	5/8	2	10/80
HSA5860		Hex Nut	5/8 x 6	5/8	2	10/80
HSA3422		Hex Nut	3/4 x 2-1/2	3/4	2-1/4	10/80
HSA3440		Hex Nut	3/4 x 4	3/4	2-1/4	10/80
HSA3461		Hex Nut	3/4 x 6-1/4	3/4	2-1/4	10/80
FSA1421		Flat Head	1/4 x 2-1/4	1/4	1-1/8	100/800
FSA1431		Flat Head	1/4 x 3-1/4	1/4	1-1/8	100/800

Order information continued on following page.

Specifications, Listings and Approvals

Diameters: 1/4" – 3/4"

Carbon Steel Anchor Materials:

- Anchor body:
 - 1/4 through 5/16: C1035
 - 3/8 through 5/8: C1010
- Anchor expansion sleeve : C1008
- Anchor spacer: C1008
- Finish: Zinc plating
 - Meets ASTM B633, SC1 Type III with clear chromate, SC1 class mild
 - Corrosion resistance: 12 hour salt spray

Stainless Steel Anchor Material:

- All components: AISI Type 304

Federal Specifications:

- QQZ-325C, Type II, Class 3 (clear chromate added)
- GSA FFS-325, Group II, Type 3, Class 3

Order Information, continued

Catalog Number		Head or Nut Style	Anchor Size (in.)	Drill Bit Size (in.)	Min. Embed. (in.)	Qty. Box/ Carton
Carbon Steel	Stainless Steel					
FSA1440		Flat Head	1/4 x 4	1/4	1-1/8	100/800
FSA3823		Flat Head	3/8 x 2-3/4	3/8	1-1/2	50/400
FSA3840		Flat Head	3/8 x 4	3/8	1-1/2	50/400
FSA3850		Flat Head	3/8 x 5	3/8	1-1/2	50/400
FSA3860		Flat Head	3/8 x 6	3/8	1-1/2	50/400

Installation Instructions

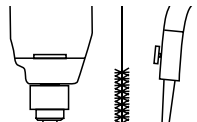
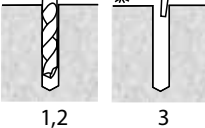
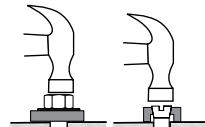
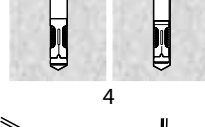
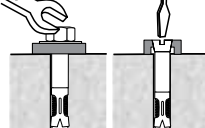
1. Drill the hole perpendicular to the work surface. To assure full holding power, do not ream the hole or allow the drill to wobble. 
2. Drill the hole deeper than the intended embedment of the anchor, but not closer than two anchor diameters to the bottom (opposite) surface of the concrete. Through drilling is allowed when using sleeve anchors in hollow concrete block. 
3. Clean the hole using compressed air and a nylon brush. A clean hole is necessary for proper performance. 
4. Assemble the washer and nut on the anchor so that the nut protrudes slightly beyond the fixture and insert anchor into the hole making sure the nut, or head, rests solidly against the fixture. 
5. Tighten the nut, or head, 3 to 5 turns past the hand tight position. 

NOTE: Always wear safety glasses. Follow drill manufacturer's instructions. Use only solid carbide-tipped drill bits meeting ANSI B212.15 diameter standards.

Information provided only for the use of a qualified design engineer. Use of technical data by persons not qualified could cause serious damage, injury or even death.

Ultimate values shown. For static loads, use one-fourth of the maximum tensile and shear capacities for the recommended 4:1 safety factor.

Edge Distance and Spacing Requirements

Embedment (E) in Anchor Diameters	Spacing	Edge Distance
E < 6d (shallow)	3.5E	1.75E
6d ≤ E ≤ 8d (standard)	2.00E	1.00E
8d < E (deep)	1.50E	0.75E

Maximum Tensile and Shear For Static Loads in Concrete

Anchor Dia. (in.)	Head or Nut Style	Drill Dia. (in.)	Bolt Size (in.)	4000 psi Concrete		
				Embed. (in.)	Tension (lb.)	Shear (lb.)
1/4	Acorn Nut	1/4	10-24	1-1/16	1049	1379
				1-11/16	1493	1774
1/4	Flat Head	1/4	10-24	1-5/8	1393	1141
				2-5/8	1470	1243
5/16	Hex Nut	5/16	1/4-20	1-3/16	1630	2225
				2-1/16	2181	2311
3/8	Hex Nut	3/8	5/16-18	1-1/4	2502	3116
				2-1/2	3046	3691
3/8	Flat Head	3/8	5/16-18	2-3/8	2928	2318
				3-11/16	2345	1954
				4-5/8	2563	2064
				5-5/8	2842	2238
1/2	Hex Nut	1/2	3/8-16	1-1/2	2656	3724
				2-3/8	4649	2726
				3-3/8	5127	4726
5/8	Hex Nut	5/8	1/2-13	2-1/4	4568	5218
				3-15/16	7285	6747
				5-7/16	7631	7689
3/4	Hex Nut	3/4	5/8-11	1-7/8	5388	7862
				3-9/16	6219	9786
				5-1/2	6456	10073

Maximum Tensile and Shear For Static Loads in Hollow Concrete Block

Anchor Dia. (in.)	Head Style	Drill Dia. (in.)	Bolt Size (in.)	Embed. (in.)	2000 psi Hollow Concrete Block			
					w/o 2000 psi grout		w/ 2000 psi grout	
					Tension (lb.)	Shear (lb.)	Tension (lb.)	Shear (lb.)
1/4	Acorn	1/4	10-24	1-1/16	943	1587	1476	1587
				1-5/8	1065	2265	1346	1518
5/16	Acorn	5/16	1/4-20	2-1/16	1127	3056	1479	2265
3/8	Hex Nut	3/8	5/16-18	1-1/4	891	3009	2311	3056
				2-1/2	625	3794	2218	3009
1/2	Hex Nut	1/2	3/8-16	1-1/2	973	4071	2094	3794
				2-3/8	-	-	2689	4071
				3-3/8	-	-	2816	5197
5/8	Hex Nut	5/8	1/2-13	3-5/16	-	-	4098	6580
				5-7/16	-	-	4432	6617
3/4	Hex Nut	3/4	5/8-11	3-9/16	-	-	4990	9888
				5-1/2	-	-	4699	9924

Source (available on request): SGS U.S. Testing Co. Inc., Tulsa, OK; 1996 (Tested in accordance with ASTM E-488).

Center Pin Drive Anchors

Nail Anchors

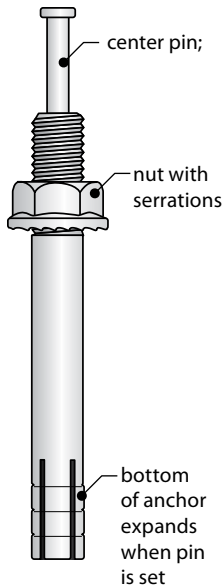

Hammer in to create tension then tighten nut to secure

Key Features/Benefits

- Easy to install
 - Just hammer the center pin and it's set
 - Anchor tensions itself automatically, so no wrench is needed
- Easy to inspect
 - Anchor is set when center pin is flush with top of hole
- Depth of hole not critical
 - No depth gauge required
- Actual diameter of the anchor is the same as its nominal diameter
 - No templates required
- Serrations on nut provide vibration resistance
- Yellow dichromate finish provides superior corrosion resistance



Specifications, Listings and Approvals

Diameters: 1/4" – 3/4"

Materials:

- **Anchor Body:** Hot Rolled Steel
- **Pin:** Hot Wrought Iron

Finish: Yellow Dichromate Coating

Federal Specifications:

- QQZ-325Z, Type II Class 3 (yellow dichromate added)
- GSA FFS-325 Group II Type 4 Class I

Order Information

Catalog Number	Anchor Size (in.)	Max. Thickness Fastened (in.)	Minimum Embedment (in.)	Box Qty.	Case Qty.
CP1413	1/4 x 1-3/4	3/8	1-1/8	100	800
CP1423	1/4 x 2-3/8	1	1-1/8	100	800
CP5620	5/16 x 2	5/16	1-3/8	100	800
CP5623	5/16 x 2-3/4	11/16	1-3/4	100	800
CP3823	3/8 x 2-3/8	5/8	1-3/8	50	400
CP3832	3/8 x 3-1/2	1-3/8	1-3/4	50	400
CP3843	3/8 x 4-3/4	2-5/8	1-3/4	50	400
CP1223	1/2 x 2-3/4	1/4	2	25	200
CP1232	1/2 x 3-1/2	3/4	2-1/4	25	200
CP1243	1/2 x 4-3/4	2	2-1/4	25	200
CP1260	1/2 x 6	3-1/4	2-1/4	25	200
CP5840	5/8 x 4	1-5/8	2-3/4	10	80
CP5860	5/8 x 6	2	2-3/4	10	80
CP3450	3/4 x 5	2	3-1/2	10	30
CP3460	3/4 x 6	2	3-1/2	10	30
CP3472	3/4 x 7-1/2	2	3-1/2	10	30

Maximum Tensile and Shear Capacity For Static Loads

Anchor Dia. (in.)	Embedment Depth (in.)	2000 psi		4000 psi	
		Tension (lb.)	Shear (lb.)	Tension (lb.)	Shear (lb.)
1/4	1-1/8	780	1000	1567	1000
5/16	1-1/2	2130	1320	3159	1320
3/8	1-7/8	2530	2580	3307	3580
1/2	2-1/2	4040	4920	5604	4920
5/8	2-3/4	6360	9200	7742	9200
3/4	3-1/2	8700	11400	12083	11400

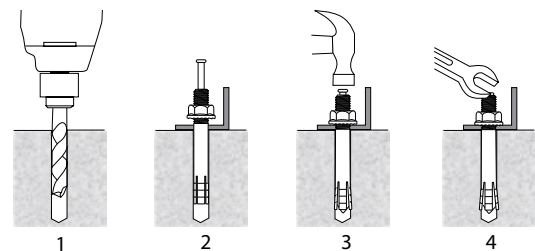

Installation Instructions

1. Drill the hole perpendicular to the work surface. To assure full holding power, do not ream the hole or allow drill to wobble. Clean hole using compressed air and a nylon brush. A clean hole is necessary for proper performance.
2. Preset the nut and washer for desired embedment.
3. Hammer center pin until it is aligned with the top of the bolt.
4. Tighten nut.

NOTE: Always wear safety glasses. Follow drill manufacturer's instructions. Use only solid carbide-tipped drill bits meeting ANSI B212.15 diameter standards.

Edge Distance Requirements

Embedment (E) in Anchor Diameters	Spacing	Edge Distance
E < 6d (shallow)	3.5E	1.75E
6d ≤ E ≤ 8d (standard)	2.00E	1.00E
8d < E (deep)	1.50E	0.75E



The ease of hammer-in installation

Key Features/Benefits

- Easy to install
- Tamper-proof
- Can be used in concrete, block, brick or stone

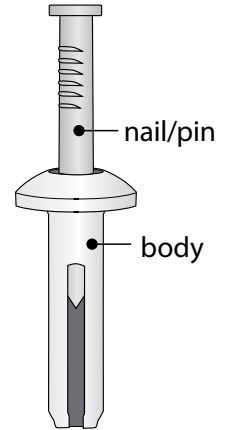

Specifications, Listings and Approvals

Diameters: 3/16" – 1/4"

Body Material: Die Cast Zamac Alloy

Pin Material: Cold Rolled Steel

Head Style: Mushroom

Finish: Zinc Plating ASTM B633

Federal Specifications

- GSA FFS-325, Group V, Type 2, Class 2

Order Information

Catalog Number	Head Style	Anchor Size (in.)	Industrial Pack Quantity Box/Carton
DN3678	Mushroom	3/16 x 7/8	100/1000
DN1403	Mushroom	1/4 x 3/4	100/1000
DN1410	Mushroom	1/4 x 1	100/1000
DN1411	Mushroom	1/4 x 1-1/4	100/1000
DN1412	Mushroom	1/4 x 1-1/2	100/800
DN1420	Mushroom	1/4 x 2	100/800
DN1422	Mushroom	1/4 x 2-1/2	100/800
DN1430	Mushroom	1/4 x 3	100/800

Maximum Tensile Guidelines For Static Loads

Catalog Number	Anchor Size (in.)	Drill Dia. (in.)	Max. Thickness of Fixture (in.)	Min. Embed. (in.)	Unreinforced Stone Aggr. Concrete – 3000 psi Tension (lb.)
DN3678	3/16 x 7/8	3/16	1/4	5/8	400
DN1403	1/4 x 3/4	1/4	1/8	5/8	500
DN1410	1/4 x 1	1/4	1/4	3/4	800
DN1411	1/4 x 1-1/4	1/4	1/2	3/4	800
DN1412	1/4 x 1-1/2	1/4	3/4	3/4	800
DN1420	1/4 x 2	1/4	1-1/4	3/4	800
DN1422	1/4 x 2-1/2	1/4	1-3/4	3/4	800
DN1430	1/4 x 3	1/4	2-1/4	3/4	800

Installation Instructions

1. Drill hole in masonry or concrete through mounting holes in fixture same diameter as anchor to be used. In wood and other soft material to be fastened, drill through fixture and directly into masonry. (Drill hole 1/4" deeper than the calculated embedment depth.) Clean hole using compressed air and a nylon brush. A clean hole is necessary for proper performance.
2. Insert anchor assembly through mounting holes in fixture and into anchor hole.
3. Tap gently until head of anchor body is set tightly against item to be fastened. Gently hammer pin flush to expand body. Do not over-drive pin into body as this could damage the anchor.

NOTE: Always wear safety glasses. Follow the drill manufacturer's safety instructions. Use only solid carbide-tipped drill bits meeting ANSI B212.15 diameter standard.

CAUTION: Drive Nail Anchors are not recommended for structural or overhead applications, nor is it for use in new concrete which has not had sufficient time to cure.

NOTE: Information provided only for the use of a qualified design engineer. Use of technical data by persons not qualified could cause serious damage, injury or even death. Ultimate values shown. For static loads, use one-fourth of the maximum tensile and shear capacities for the recommended 4:1 safety factor.

Source (available upon request): UES Technical Information.

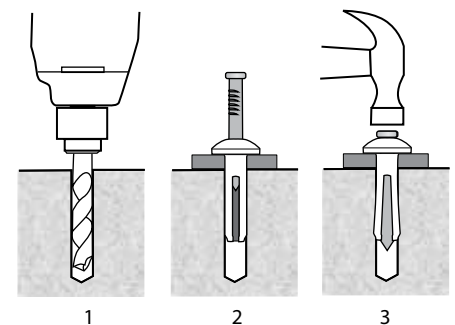

POWER Screw Bolt™

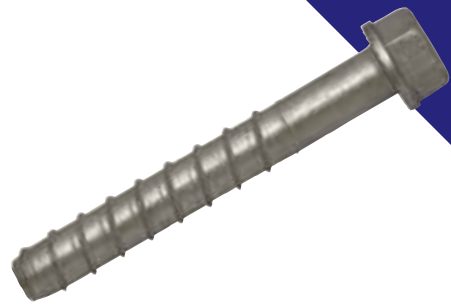

Specifications, Listings and Approvals

Diameters: 1/4" – 3/4"

Anchor Body: Heat treated carbon steel

Finish:

- 1/4" anchors have zinc electroplated to ASTM B633, Type III, SC1
- All other sizes are mechanically galvanized to ASTM B695, Class 65, Type 1

Head Style: Hex flange head with locking serrations

Tested in accordance with ASTM E488

Uses

- Applications with minimal edge distances
- Applications where a zinc anchor or galvanized anchoring is advised
- **Temporary outdoor** and some indoor dry-treated lumber applications

Undercut threads and serrated head provide high performance

Key Features & Benefits

- One-piece screw bolt
 - No nuts and washers to assemble prior to installation
- Heat treatment provides surface and core hardness
- Electroplated zinc or heavy-duty, **mechanically galvanized** finish available
- Hardened, self-tapping threads feature a revolutionary undercutting design
 - Allows for immediate load application
 - Reduces required installation torque
- Easier and faster installation than mechanical expansion anchors
 - **Bolt Size is Hole Size®**
 - Prepare hole with lower-cost ANSI B212.15 standard bit – **no metric or off-size bits needed**
- Serrated head facilitates a positive lock between bolt and application surface for enhanced vibration resistance
- Lower spacing and edge distance requirements than mechanical expansion anchors
- Can be installed with an impact or socket wrench
- Removable – ideal for temporary anchoring applications
- Anchor length is stamped on head to ease identification pre- and post-installation

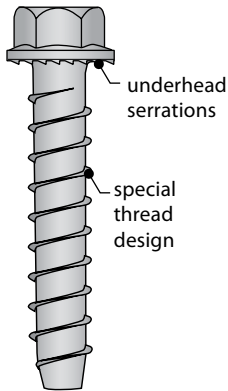

Threaded Anchors

Order Information

Catalog No.	Plating Type	Head Style	Anchor Size (in.)	Bit Dia. (in.)	Baseplate Clearance Hole	Qty. Box/ Carton
ATEZ1413	Zinc	Hex	1/4 x 1-3/4	1/4	3/8	100/800
ATEZ1421	Zinc	Hex	1/4 x 2-1/4	1/4	3/8	100/800
ATEZ1430	Zinc	Hex	1/4 x 3	1/4	3/8	100/800
ATEZG3830	Mech Galv	Hex	3/8 x 3	3/8	1/2	50/400
ATEZG3840	Mech Galv	Hex	3/8 x 4	3/8	1/2	50/400
ATEZG3850	Mech Galv	Hex	3/8 x 5	3/8	1/2	25/200
ATEZG3860	Mech Galv	Hex	3/8 x 6	3/8	1/2	25/200
ATEZG1230	Mech Galv	Hex	1/2 x 3	1/2	5/8	20/160
ATEZG1240	Mech Galv	Hex	1/2 x 4	1/2	5/8	20/160
ATEZG1250	Mech Galv	Hex	1/2 x 5	1/2	5/8	20/160
ATEZG1260	Mech Galv	Hex	1/2 x 6	1/2	5/8	20/160

Catalog No.	Plating Type	Head Style	Anchor Size (in.)	Bit Dia. (in.)	Baseplate Clearance Hole	Qty. Box/ Carton
ATEZG1270	Mech Galv	Hex	1/2 x 7	1/2	5/8	20/160
ATEZG5840	Mech Galv	Hex	5/8 x 4	5/8	3/4	10/80
ATEZG5850	Mech Galv	Hex	5/8 x 5	5/8	3/4	10/80
ATEZG5860	Mech Galv	Hex	5/8 x 6	5/8	3/4	10/80
ATEZG5870	Mech Galv	Hex	5/8 x 7	5/8	3/4	10/80
ATEZG5880	Mech Galv	Hex	5/8 x 8	5/8	3/4	10/80
ATEZG3440	Mech Galv	Hex	3/4 x 4	3/4	7/8	10/80
ATEZG3450	Mech Galv	Hex	3/4 x 5	3/4	7/8	10/80
ATEZG3460	Mech Galv	Hex	3/4 x 6	3/4	7/8	10/60
ATEZG3470	Mech Galv	Hex	3/4 x 7	3/4	7/8	5/30

Installation in Concrete

1. Using the proper size carbide bit, drill a pilot hole at least one anchor diameter deeper than the desired anchor embedment.
2. Blow out concrete dust.
3. Using an electric impact wrench, or socket wrench, insert anchor into hole and tighten anchor until fully seated. If using an electric impact wrench, start on light torque setting to prevent over torturing or damaging threads.

NOTE: Always wear safety glasses.

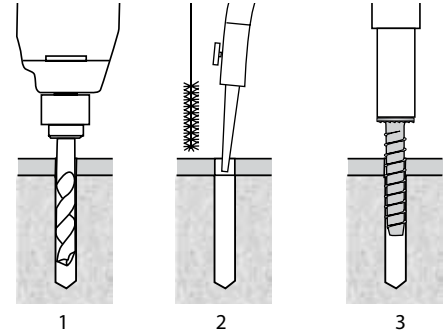

Installation in Concrete Block (CMU)

NOTE: Do not use an impact wrench for installation into CMU walls.

1. Using the proper size carbide bit, drill a pilot hole at least one anchor diameter deeper than the desired anchor embedment.
2. Blow out concrete dust.
3. Using a socket wrench insert anchor into hole and hand tighten anchor until fully seated.

NOTE: Always wear safety glasses.

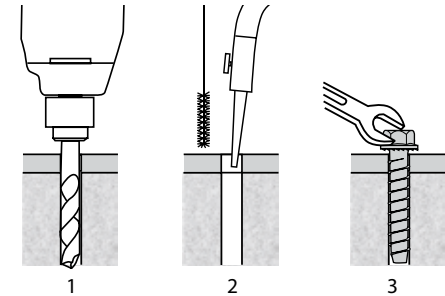

*To assure full load values, do not ream the hole or allow the drill bit to wobble. Use solid carbide-tipped drill bits meeting ANSI B212.15 diameter standards.

Performance Data Installation Information

	Units	Nominal Anchor Diameter									
		1/4 "		3/8 "		1/2 "		5/8 "		3/4 "	
Drill Bit Diameter*	in.	1/4		3/8		1/2		5/8		3/4	
Minimum Baseplate Clearance Hole	in.	3/8		1/2		5/8		3/4		7/8	
Installation Torque Approx.	ft.-lb.	8	8	25	25	55	55	95	95	150	150
Socket Size	in.	7/16	7/16	9/16	9/16	3/4	3/4	15/16	15/16	1-1/8	1-1/8
Embedment Depth h_{nom}	in.	1-3/16	2-1/2	2	3-1/2	2	3-1/2	2	3-1/2	2-1/2	4
Effective Embed. Depth	in.	3/4	2	1-1/4	2-11/16	1-1/4	2-3/4	3/4	2-1/2	1-5/8	3-1/8
Minimum Hole Depth	in.	1-11/16	3	2-1/2	4	2-1/2	4	2-1/2	4	3	4-1/2
Critical Edge Distance	in.	2	2	2-3/4	4-1/8	3-3/4	6	5	6-1/4	6-1/2	7-1/4
Minimum Edge Distance	in.	1-3/4	1-3/4	1-3/4	1-3/4	1-3/4	1-3/4	1-3/4	1-3/4	1-3/4	1-3/4
Critical Spacing	in.	3	3	6	6	8	8	10	10	12	12
Minimum Spacing	in.	1	1	1-1/2	1-1/2	2	2	2-1/2	2-1/2	3	3
Head & Washer Height min.	in.	1/4	1/4	3/8	3/8	31/64	31/64	19/32	19/32	45/64	45/64
Washer Outer Dia., Approx.	in.	1/2	1/2	3/4	3/4	1	1	1-5/32	1-5/32	1-3/8	1-3/8

* ANSI B212 .15 Solid Carbide Tipped Drill Bit

Performance Data – ASD

	Units	Anchor Diameter									
		1/4"		3/8"		1/2"		5/8"		3/4"	
Embedment h_{nom}	in.	1-3/16	2-1/2	2	3-1/2	2	3-1/2	2-1/2	3-1/2	2-1/2	5-3/4
Ultimate Tension	lbf	1025	3450	4248	11150	4758	12027	4689	13363	7042	27010
Allowable Tension	lbf	256	863	1062	2788	1190	3007	1172	3341	1761	6752
Ultimate Shear	lbf	2680	2680	8240	8240	9070	14670	12147	23660	14145	31734
Allowable Shear	lbf	670	670	2060	2060	2267	3667	3162	5915	3536	7933

Load Adjustment Factors – Spacing

		Units	Anchor Diameter							
			3/8"		1/2"		5/8"		3/4"	
Embedment	h_{nom}	in.	2	3-1/2	2	3-1/2	2	3-1/2	2-1/2	4
Critical Spacing	S_{cr}	in.	6	6	8	8	10	10	12	12
Minimum Spacing	S_{min}	in.	1-1/2	1-1/2	2	2	2-1/2	2-1/2	3	3
Actual Spacing S_{act}	1-1/2	in.	0.70	0.60						
	2	in.	0.76	0.64	0.75	0.70				
	2-1/2	in.	0.80	0.70	0.77	0.73	0.85	0.79		
	3	in.	0.84	0.76	0.80	0.77	0.87	0.81		
	3-1/4	in.	0.88	0.82	0.84	0.81	0.89	0.85	0.75	0.70
	4	in.	0.92	0.88	0.88	0.84	0.90	0.88	0.80	0.77
	5	in.	0.96	0.94	0.91	0.88	0.91	0.90	0.84	0.78
	6	in.	1.00	1.00	0.94	0.92	0.92	0.93	0.87	0.81
	7	in.			0.97	0.95	0.94	0.95	0.89	0.84
	8	in.			1.00	1.00	0.96	0.97	0.90	0.88
	9	in.					0.98	0.98	0.91	0.91
	10	in.					1.00	1.00	0.94	0.97
11	in.							0.97	0.97	
12	in.							1.00	1.00	

Notes: 4K psi concrete

Load Adjustment Factors – Edge

		Units	Anchor Diameter							
			3/8"		1/2"		5/8"		3/4"	
Embedment	h_{nom}	in.	2	3-1/2	2	3-1/2	2	3-1/2	2-1/2	4
Critical Edge	C_{cr}	in.	2-3/4	4-1/8	3-3/4	6	5	6-1/4	6-1/2	7-1/4
Minimum Edge	C_{min}	in.	1-3/4	1-3/4	1-3/4	1-3/4	1-3/4	1-3/4	1-3/4	1-3/4
Actual Edge C_{act}	1-3/4	in.	0.79	0.77	0.62	0.64	0.70	0.60	0.75	0.60
	2	in.	0.88	0.82	0.72	0.68	0.76	0.66	0.77	0.62
	2-1/4	in.	0.92	0.84	0.76	0.70	0.78	0.68	0.78	0.63
	2-1/2	in.	0.96	0.86	0.80	0.72	0.80	0.70	0.79	0.64
	2-3/4	in.	1.00	0.88	0.84	0.74	0.83	0.72	0.80	0.65
	3	in.		0.90	0.88	0.76	0.85	0.74	0.81	0.66
	3-1/4	in.		0.92	0.92	0.78	0.86	0.76	0.82	0.67
	3-1/2	in.		0.94	0.96	0.80	0.87	0.78	0.83	0.68
	3-3/4	in.		0.96	1.00	0.82	0.88	0.80	0.84	0.69
	4	in.		0.98		0.84	0.90	0.82	0.85	0.70
	4-1/8	in.		1.00		0.86	0.94	0.84	0.86	0.71
	4-1/2	in.				0.88	0.96	0.86	0.87	0.72
	4-3/4	in.				0.90	0.98	0.88	0.88	0.73
	5	in.				0.92	1.00	0.90	0.89	0.74
	5-1/4	in.				0.94		0.92	0.90	0.78
	5-1/2	in.				0.96		0.94	0.92	0.81
	5-3/4	in.				0.98		0.96	0.94	0.85
	6	in.				1.00		0.98	0.96	0.89
	6-1/4	in.						1.00	0.98	0.94
	6-1/2	in.							1.00	0.95
6-3/4	in.								0.97	
7	in.								0.99	
7-1/4	in.								1.00	

Notes: 4K psi concrete

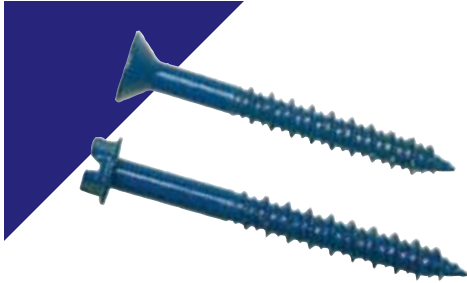

Specifications, Listings and Approvals

Thread size:

- 3/16" : .210 O.D.; .123 I.D.; .146" unthreaded shank diameter
- 1/4" : .255 O.D.; .161 I.D.; .189" unthreaded shank diameter

Material: C1022 Steel

Case Hardened: HRC 52 min. with core hardness of HRC 32 – 40 max.

Finishes: Stalgard® coating

Strength:

- Tensile Yield: 155 K.S.I.
- Tensile Ultimate: 177 K.S.I.

Miami-Dade, Florida Notice of Acceptance (NOA): #11-0406.01

Threaded anchors featuring twin-lead threads and Stalgard® coating

Key Features/Benefits

- Cuts threads in structural concrete, hollow block, brick, mortar, CMU, etc.
- Twin-lead threads with V-notches
 - Eases installation
 - Increases pullout values
- Slotted hex washer head and phillips flat head available
- Gimlet point
- Drill bit included in each box
- Blue Stalgard® finish
 - Provides **1000 hours** of salt spray resistance per ASTM B117
 - ACQ-compatible
- Eliminates need for inserts
- Can be removed and reinstalled as often as necessary

Uses

- Masonry and concrete applications where a removable screw is required
- ACQ-treated lumber applications

Code Compliance:
Miami-Dade
NOA
#11-0406.01

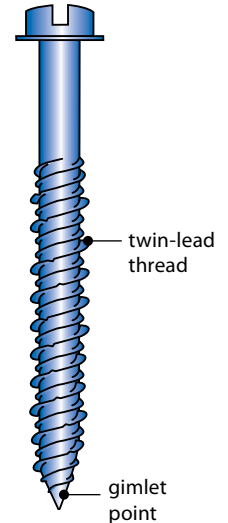

Threaded Anchors



Order Information

NOTE: 1 tanged drill bit per box

	Catalog No.	Size	Drive System	Quantity Per Box	Quantity Per Master
Slotted Hex Washer Head					
	HCS3611	3/16 x 1-1/4"	5/16 hex with slot	100	600
	HCS3613	3/16 x 1-3/4"	5/16 hex with slot	100	600
	HCS3621	3/16 x 2-1/4"	5/16 hex with slot	100	600
	HCS3623	3/16 x 2-3/4"	5/16 hex with slot	100	600
	HCS3631	3/16 x 3-1/4"	5/16 hex with slot	100	600
	HCS3633	3/16 x 3-3/4"	5/16 hex with slot	100	600
	HCS3640	3/16 x 4"	5/16 hex with slot	100	600
	HCS1411	1/4 x 1-1/4"	5/16 hex with slot	100	600
	HCS1413	1/4 x 1-3/4"	5/16 hex with slot	100	600
	HCS1421	1/4 x 2-1/4"	5/16 hex with slot	100	600
	HCS1423	1/4 x 2-3/4"	5/16 hex with slot	100	600
	HCS1431	1/4 x 3-1/4"	5/16 hex with slot	100	600
	HCS1433	1/4 x 3-3/4"	5/16 hex with slot	100	600
	HCS1440	1/4 x 4"	5/16 hex with slot	100	600
	HCS1450	1/4 x 5"	5/16 hex with slot	100	100
	HCS1460	1/4 x 6"	5/16 hex with slot	100	100

Order information continued on following page.

Order Information, continued

NOTE: 1 tanged drill bit per box

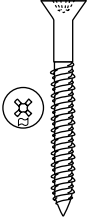
	Catalog No.	Size	Drive System	Quantity Per Box	Quantity Per Master
Phillips Flat Head					
	FCS3611	3/16 x 1-1/4"	#2 phillips	100	600
	FCS3613	3/16 x 1-3/4"	#2 phillips	100	600
	FCS3621	3/16 x 2-1/4"	#2 phillips	100	600
	FCS3623	3/16 x 2-3/4"	#2 phillips	100	600
	FCS3631	3/16 x 3-1/4"	#2 phillips	100	600
	FCS3633	3/16 x 3-3/4"	#2 phillips	100	600
	FCS3640	3/16 x 4"	#2 phillips	100	600
	FCS1411	1/4 x 1-1/4"	#3 phillips	100	600
	FCS1413	1/4 x 1-3/4"	#3 phillips	100	600
	FCS1421	1/4 x 2-1/4"	#3 phillips	100	600
	FCS1423	1/4 x 2-3/4"	#3 phillips	100	600
	FCS1431	1/4 x 3-1/4"	#3 phillips	100	600
	FCS1433	1/4 x 3-3/4"	#3 phillips	100	600
	FCS1440	1/4 x 4"	#3 phillips	100	600
	FCS1450	1/4 x 5"	#3 phillips	100	100
	FCS1460	1/4 x 6"	#3 phillips	100	100

Installation Instructions

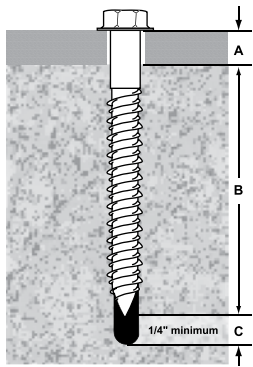

A = Attachment thickness
 B = Embedment (min. of 1", max. of 1-3/4")

 A + B = UltraCon anchor length
 B + C = Hole depth (must be at least 1/4" deeper than embedment)

- It is recommended that a minimum of 1" and a maximum of 1-3/4" embedment be used in determining fastener length.
- The correct hole depth (B & C) can normally be obtained by drilling the full length of Elco® carbide-tipped drill bit supplied with each box of UltraCon fasteners. In all cases, the hole must be at least 1/4" deeper than the depth of the fastener embedment.
- Normal safety precautions should be observed when drilling the holes to avoid electrical installations, other utilities and reinforcement bars.

Performance Data

Dia.	Hollow Block 1,924 psi				Concrete 2,730 psi			
	Depth of Embed.	Edge Dist.	Pull-out (lb.)	Shear (lb.)	Depth of Embed.	Edge Dist.	Pull-out (lb.)	Shear (lb.)
3/16"	1-1/4"	1"	421	546	1"	1"	422	692
					1-3/8"		884	782
					1-3/4"		1,096	856
	2-1/2"	427	575	1"	2-1/2"	444	639	
				1-3/8"		750	866	
				1-3/4"		1,271	781	
1/4"	1-1/4"	1"	998	900	1"	1"	668	632
					1-3/8"		1,166	1,070
					1-3/4"		1,857	919
	2-1/2"	709	1,486	1"	2-1/2"	809	1,153	
				1-3/8"		1,507	1,583	
				1-3/4"		1,908	1,780	

Test report cross-reference information

Concrete		Block	
Anchor Dia.	Test Report No.	Anchor Dia.	Test Report No.
3/16"	HETI 03-1127	3/16"	HETI 05-1501
1/4"	HETI 03-1136	1/4"	HETI 03-1159

* Testing by Hurricane Engineering & Testing, Inc. (HETI). Testing was done per ASTM E8-96 standards. The yield and ultimate tensile values shown are indicative of the hardness levels obtained.

NOTE: Indicated pull-out and shear failure values were obtained in tests witnessed by independent test labs (see below). These figures are offered only as a guide and are not guaranteed in any way by Elco Construction Products. A safety factor of 4:1, or 25% of ultimate pull-out value, is generally accepted as a safe working load; however, reference should always be made to applicable codes for the specific safe working ratio.

POWER-Drop™ Drop-In Anchors

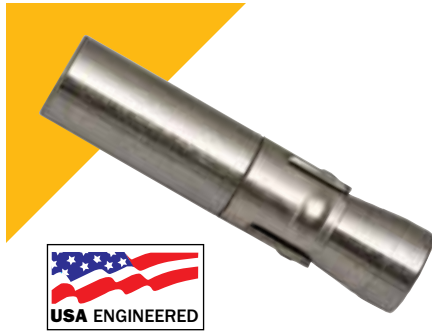

Specifications, Listings and Approvals

For bolt or rod diameters 3/8" – 1"

Material: Carbon steel

Finish: Zinc Plating ASTM B633, Type III, SC1

Approvals:

- 2000 International Building Code (IBC)
- 2000 International Residential Code (IRC)
- 1997 Uniform Building Code (UBC)
- Data Test in accordance with ICC-ES Criteria for Expansion Anchors in Concrete and Masonry Elements (ACOI) dated April 2002
- Formerly ICC-ES Legacy Report #5063

Combines a wedge anchor with a drop-in

Key Features/Benefits

- Internally threaded anchor
- **Wedge anchor performance** with the convenience of a drop-in
- Safety shoulder
 - Supports clip when anchor is under strain to eliminate bolt-end collapse and/or clip slippage under ultimate loading conditions
- Seismic rated
 - Allowable values may be increased 33.3% for short-term loading in resisting earthquake or wind loads
- **Numerous head style options**
 - May be used with machine screws, tamper-proof bolts, threaded rod and a variety of other male-threaded fasteners
- Available in a variety of sizes

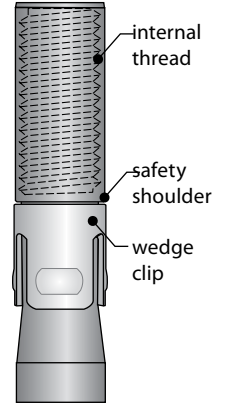

Order Information

POWER-Drop Anchors				
Catalog Number	For Bolt Size (in.)	Anchor Dimensions (in.)	Thread Depth (in.)	Quantity Box/ Carton
PD38	3/8	1/2 x 2-5/16	1-1/16	25/200
PD12	1/2	5/8 x 3-3/32	1-1/2	10/80
PD58	5/8	7/8 x 3-13/16	1-1/2	5/30
PD34	3/4	1 x 4-5/8	1-23/32	5/30
PD1	1	1-1/4 x 5	1-1/2	5/30

Tool Information

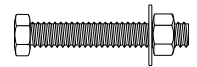

POWER-Drop Setting Tools*			
Catalog Number	Installs Bolt Size (in.)	Tool Dim. (in.)	Threads Per Inch
PDST38	3/8	3/8 x 3	16
PDST12	1/2	1/2 x 3-1/2	13
PDST58	5/8	5/8 x 4	11
PDST34	3/4	3/4 x 4-1/2	10
PDST1	1	1 x 4-1/2	8

*Note: One setting tool included per box of anchors.

Recommended Spacing and Edge Distance Requirements

Catalog No.	Min. Edge Distance (in.)	Tension Load Factor for Min. Edge Distance	Shear Load Factor for Min. Edge	Min. Spacing Distance (in.)	Tension Load Factor for Min. Spacing	Shear Load Factor for Min. Spacing	Installation Spacing (in.)
PD38	2-5/8	0.7	0.5	2-5/8	0.5	0.4	5/16
PD12	3-1/2	0.7	0.5	3-1/2	0.5	0.4	3/8
PD58	4-3/8	0.7	0.5	4-3/8	0.5	0.4	1/2
PD34	5-1/4	0.7	0.5	5-1/4	0.5	0.4	5/8
PD1	5-3/4	0.7	0.5	5-3/4	0.35	0.4	3/4

POWER-Drop™ and Standard Drop-In Anchors

Installation Instructions: POWER-Drop Anchors

1. Drill the hole perpendicular to the work surface. Do not ream the hole or allow the drill to wobble. Drill the hole to the proper minimum hole depth as shown in the chart for the anchor to be installed.
2. Thoroughly clean hole using compressed air and a nylon brush. An unclean hole may compromise anchor performance.
3. Set the initial anchor embedment: Thread the sacrificial cap screw with assembled nut and washer fully into the anchor. Refer to the table for Installation Spacing, then set that distance between the top of the anchor and the bottom of the washer to match this value.
4. After setting the installation spacing, place the anchor into the hole and hammer downward on the top of the sacrificial cap screw until the nut makes contact with the surface of the concrete.
5. To set the anchor you must tighten the nut. You may need to keep the cap screw from turning. Refer to Installation Turns as shown in the chart below.
6. Once the anchor is set remove the cap screw and clear the anchor with compressed air to remove any concrete dust from the threads

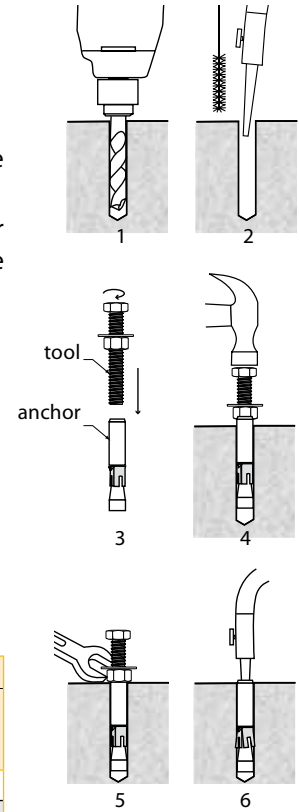

NOTE: Always wear safety glasses. Follow drill manufacturer's instructions. Use only solid carbide-tipped drill bits meeting ANSI B212.15 diameter standards

Maximum Tensile Capacity For Static Loads

Cat. No.	For Bolt Size	Anchor Dimensions (in.)	Min. Hole Depth (in.)	H _{nom} Embedment Depth (in.)	Installation Torque	Installation Turns	Drill Dia. (in.)	4000 psi	
								Tension (lb.)	Shear (lb.)
PD38	3/8 UNC	1/2 x 2-5/16	3	2-5/8	25	2-1/2	1/2	6409	4200
PD12	1/2 UNC	5/8 x 3-3/32	4	3-15/32	55	2-1/2	5/8	10352	7340
PD58	5/8 UNC	7/8 x 3-13/16	5	4-5/16	90	3	7/8	16500	11880
PD34	3/4 UNC	1 x 4-5/8	5-3/4	5-1/4	175	4	1	21409	13360
PD1	1 UNC	1-1/4 x 5	6-1/2	5-3/4	290	3	1-1/4	24752	26440

Drop-In Anchors



Drop-In Anchors/Mini Drop-In Anchors



Specifications, Listings and Approvals

Materials:

- Carbon steel with zinc plating
 - ASTM B633 Type III, SC1 (clear chromate added)
- Type 303 and Type 316 stainless steel

Thread: UNC Coarse Thread

Federal Specifications: GSA FFS-325, Group VIII, Type I

Underwriters Laboratory: File #EX 3875

Key Features /Benefits

- Requires relatively shallow embedment
- Eliminates requirement for rod couplings in overhead applications
- Highly dependable – complete anchor setting is assured
- Simply drive the internal expander plug with a hammer or mallet
- Available options
 - **Lipped version:** sets flush with concrete
 - **Mini drop-in anchors:** ideal for hollow core, precast and post-tension slabs

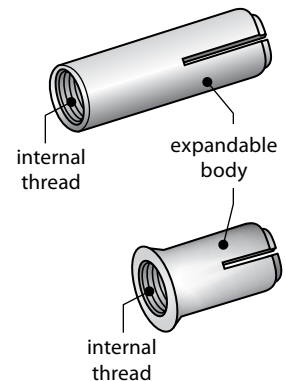

Order information on following page.

Order Information

NOTE: One setting tool included in each box of anchors

Catalog Number				Setting Tool	Anchor Thread Size (in.)	Anchor Size (in.)	Quantity Box/ Carton
Carbon	Lipped Carbon	303 Stainless Steel	316 Stainless Steel				
WD14	WDL14	WDS14	WDSS14	ST14	1/4	3/8 x 1	100/1000
-	WDM38	-	-	STM38	3/8	1/2 x 3/4	50/500
WD38	WDL38	WDS38	WDSS38	ST38	3/8	1/2 x 1-5/8	50/500
WDU38*	-	-	-	ST38	3/8	1/2 x 1-5/8	50/500
WD12	WDL12	WDS12	WDSS12	ST12	1/2	5/8 x 2	50/500
WDU12*	-	-	-	ST12	1/2	5/8 x 2	50/500
WD58	-	WDS58	WDSS58	ST58	5/8	7/8 x 2-1/2	25/200
WD34	-	WDS34	WDSS34	ST34	3/4	1 x 3-1/4	25/150

* May qualify as domestic substitute under WTO Free Trade Agreement.

Maximum Tensile and Shear Guidelines For Static Loads

Catalog No.	Anchor Thread Dia. (in.)	Drill Dia. (in.)	Max. Tight. Torque T/Max (ft-lb.)	Embed. Depth (in.)	4000 psi Unreinforced Stone Aggregate Concrete	
					Tension (lb.)	Shear (lb.)
WD14	1/4	3/8	5	1	2629	1709
WDL14	1/4	3/8	5	1	2629	1709
WDM38	3/8	1/2	5	3/4	2230	2903
WD38	3/8	1/2	10	1-5/8	4165	2889
WDU38*	3/8	1/2	10	1-5/8	4165	2889
WDL38	3/8	1/2	10	1-5/8	4165	2889
WD12	1/2	5/8	20	2	7114	5060
WDU12*	1/2	5/8	20	2	7114	5060
WDL12	1/2	5/8	20	2	7114	5060
WD58	5/8	7/8	40	2-1/2	8571	8263
WD34	3/4	1	70	3-1/4	12971	11760
WDS14	1/4	3/8	5	1	2410	1670
WDS38	3/8	1/2	10	1-5/8	3990	2710
WDS12	1/2	5/8	20	2	6995	4850
WDS58	5/8	7/8	40	2-1/2	-	-
WDS34	3/4	1	70	3-1/4	-	-
WDSS14	1/4	3/8	5	1	-	-
WDSS38	3/8	1/2	10	1-5/8	-	-
WDSS12	1/2	5/8	20	2	-	-
WDSS58	5/8	7/8	40	2-1/2	-	-
WDSS34	3/4	1	70	3-1/4	-	-

Source (available on request): SGS U.S. Testing Co., Inc., Tulsa, OK, 1996

Edge Distance and Spacing Requirements

Embedment (E) in Anchor Dia. (d)	Spacing	Edge Distance
$E < 6d$ (shallow)	3.50E	1.75E
$6d \leq E \leq 8d$ (standard)	2.00E	1.00E
$8d < E$ (deep)	1.50E	0.75E

Installation Instructions

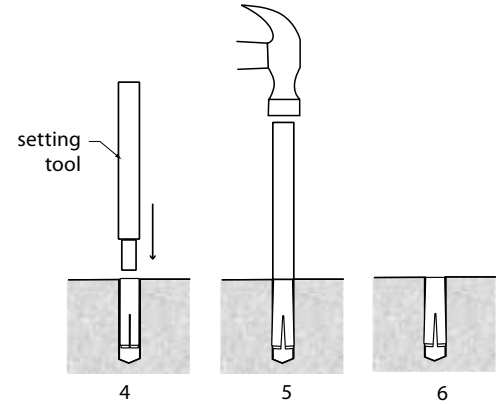
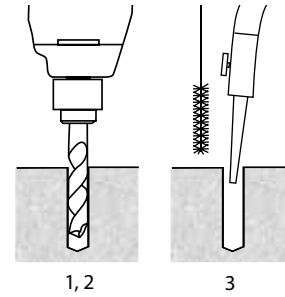

1. Select the proper size drill bit from the Maximum Tensile Chart. Drill the hole perpendicular to the work surface. To assure full holding power, do not ream the hole or allow the drill to wobble.
2. Drill the hole at least as deep as the full length of the anchor, but not closer than two anchor diameters to the bottom (opposite) surface of the concrete.
3. Clean the hole using compressed air and a nylon brush.
4. Tap the anchor, threaded portion last, into the hole. Make sure that the top of the anchor is flush with, or below, the level of the work surface.
5. Insert the setting tool into the threaded end of the anchor and expand the anchor by striking the end of the setting tool with a hammer. The anchor is set (fully expanded) when the shoulder of the setting tool touches the anchor. **Full expansion is necessary for proper anchor performance.**
6. The anchor is now ready to accept threaded hardware.

NOTE: Always wear safety glasses. Follow the drill manufacturer's safety instructions. Use only solid carbide-tipped drill bits meeting ANSI B212.15 diameter standards.

Expansion Shields



Single Expansion Shields

Key Features/Benefits

- Holding power unaffected if bolt is removed and replaced
- One-piece design
- Entire fastener is corrosion-resistant



Order Information and Performance Data

Catalog No.	For Bolt Size	Drill Dia. (in.)	Anchor Length (in.)	Qty. Box/ Carton	2000 psi		Max. Tightening Torque T/Max (ft-lb.)
					Max. Tensile Strength (lb.)	Max. Shear Strength (lb.)	
SES14	1/4-20	1/2	1-5/16	100/1000	860	1560	5
SES56	5/16-18	5/8	1-1/2	50/500	1400	1990	7
SES38	3/8-16	5/8	1-1/2	50/500	1620	3410	10
SES12	1/2-13	7/8	2	25/200	2810	5310	20
SES58	5/8-11	1	2-5/8	25/200	4720	9900	30

Specifications, Listings and Approvals

Anchor Shield and Cone Material:
Zamac Alloy

Federal Specifications: GSA FFS-325, Group II, Type 2, Class 2, Style 1

Installation Instructions – Single and Double Expansion Shields:

1. Drill hole of recommended diameter (slightly deeper than length of shield).
2. Clean the hole using compressed air and a nylon brush.
3. Install shield flush with surface of hole threaded side down. Double shield should be flush to slightly below masonry.
4. Place fixture. Insert machine bolt through fixture into shield and tighten.
5. **Single:** To determine length of bolt: thickness of fixture plus length of shield, equals length of bolt
Double: A deep setting increases holding power of masonry. If desired, place a pipe sleeve between shield and fixture being attached.

NOTE: Always wear safety glasses. Follow the drill manufacturer's safety instructions. Use only solid carbide-tipped drill bits meeting ANSI B212.15 diameter standards.

Double Expansion Shields

Key Features/Benefits

- Eliminates high stress points which can be detrimental in fastening into materials of medium hardness
- Expands fully to provide high-gripping power
- Ideal for shear loads or where joint is subject to side pressure or vibration



Order Information and Performance Data

Cat. No.	For Bolt Size (UNC)	Drill Dia. (in.)	Anchor Length (in.)	Qty. Box/ Carton	2000 psi		Max. Tightening Torque T/Max (ft-lb.)
					Max. Tensile Strength (lb.)	Max. Shear Strength (lb.)	
DES14	1/4-20	1/2	1-5/16	100/1000	1190	1500	5
DES56	5/16-18	5/8	1-1/4	50/500	1525	1890	7
DES38	3/8-16	3/4	1-1/2	50/400	2175	3290	10
DES12	1/2-13	7/8	2	25/200	4600	5100	20
DES58	5/8-11	1	2-1/4	25/200	5210	9900	30
DES34	3/4-10	1-1/4	2-7/8	10/80	9650	13600	40

Specifications, Listings and Approvals

Anchor Shield and Cone Material:
Zamac Alloy

Federal Specifications: GSA FF-S-325, Group II, Type 2, Class 2, Style 2



Specifications, Listings and Approvals

Material: Zamac Alloy

Federal Specifications: GSA FFS-325C, Group 2, Type 1, Class 1 (long), Class, 2C (short)

Lag Screw Shields

Key Features/Benefits

- Rustproof
- Suitable for masonry and masonry joints
- Longer lengths add joint strength in softer materials

Order Information and Performance Data

Cat. No.	Description	For Bolt Size (in.)	Drill Dia. (in.)	Quantity		Allowable Tension Load 2000 psi (lb.)
				Box	Carton	
LSS14	Short	1/4 x 1	1/2	50	1000	75
LSS56	Short	5/16 x 1-1/4	1/2	50	1000	105
LSS38	Short	3/8 x 1-3/4	5/8	50	500	230
LSS12	Short	1/2 x 2	3/4	25	250	250
LSS58	Short	5/8 x 2	7/8	25	250	430
LSL14	Long	1/4 x 1-1/2	1/2	50	1000	120
LSL56	Long	5/16 x 1-3/4	1/2	50	1000	155
LSL38	Long	3/8 x 2-1/2	5/8	50	500	255
LSL12	Long	1/2 x 3	3/4	25	250	300
LSL58	Long	5/8 x 3-1/2	7/8	25	200	850

* Allowable load capabilities listed are based on a 4 to 1 safety factor.



Specifications, Listings and Approvals

Materials

- Cone: Die Cast Zamac Alloy
- Expander: 3-5% Antimonial Lead

Federal Specifications: A-A 1922A, Type 1 and FFS-325C, Group 1, Type 1, Class 1

Machine Screw Anchors

Key Features/Benefits

- Closed bottom
- Setting tool provided in each box of anchors
- Fits into irregular holes
- Rustproof

Order Information and Performance Data

Catalog No.	Anchor Size (in.)	Drill Dia. (in.)	For Bolt Size (in.)	Quantity		Max. Tightening Torque (ft-lb.)
				Box	Carton	
MS14	1/4-20 x 7/8	1/2	1/4	100	2000	5
MS56	5/16-18 x 1	5/8	5/16	50	1000	7
MS38	3/8-16 x 1-1/4	3/4	3/8	50	500	10

Installation Instructions

1. Drill the hole equal to the nominal diameter of the anchor. To assure full holding power, do not ream the hole or allow the drill to wobble.
2. Drill the hole deeper than the intended embedment, but not closer than two diameters to the bottom (opposite) surface of the concrete.
3. Clean the hole with a nylon brush and compressed air.
4. Insert anchor into the hole.
5. Using setting tool, drive expander shield over cone.
6. Position fixture, insert fastener and tighten.

NOTE: Always wear safety glasses. Follow drill manufacturer's instructions. Use only solid carbide-tipped drill bits meeting ANSI B212.15 diameter standards.

TOGGLER® Plastic Toggle Anchors

TOGGLER®
HIGH-PERFORMANCE ANCHORS™



TA® Hollow-Core Door/
Thin Panel Anchor



TB® Residential
Drywall Anchor



TC® Commercial
Drywall Anchor



TD Double
Drywall Anchor



Key Features/Benefits

- Easy, secure, vibration-proof anchoring for medium loads
- **Third-generation design** provides increased holding strength and abuse resistance
- Vibration and shock proof – won't damage walls or ceiling
- All install in only a **small 5/16" hole**
- Can be pre-installed without the screw
- Key-activated positive locking system
- Low friction, self-lubricating – eases screw insertion
- Anti-rotation fins prevent spinning, even when using a screw gun
- Non-conductive (Dielectric constant 2.30x10⁶Hz), allowing safe anchoring of electrical apparatus
- Non-corrodible – safely used with stainless steel screws in corrosive environments
- Toughness with elasticity, even at temperature extremes ranging from -20° F to 212° F
- All TOGGLER hollow-wall anchors will function without modification as wedge or as expansion anchors in materials thicker than the anchor's grip range

Do not store in direct sunlight, or use in applications exposed to long-term direct sunlight. In nearly all applications, the anchor is hidden from UV exposure by the fastened object or the installation location. All anchors available, on special order, in black for high UV-resistance.

Order Information

Cat. No.	Description	Grip Range/ Wall Depth	Drill Dia.	Screw Size Range	Included Screw Size*	Box / Bag (pcs.)	Inner Carton (pcs.)	Master Carton (pcs.)
11009	TA Hollow Door Anchors	1/8" – 1/4"	5/16"	#8 – 12	no screws	100	1000	5000
50275	TA Hollow Door Anchors	1/8" – 1/4"	5/16"	#8 – 12	#8 x 1-1/4	5	50	1000
50280	TA Hollow Door Anchors	1/8" – 1/4"	5/16"	#8 – 12	#8 x 1-1/4	20	200	2000
11010	TB Residential Drywall Anchors	3/8" – 1/2"	5/16"	#6 – 14	no screws	100	1000	5000
50300	TB Residential Drywall Anchors	3/8" – 1/2"	5/16"	#6 – 14	#8 x 1-1/2	5	50	1000
50525	TB Residential Drywall Anchors	3/8" – 1/2"	5/16"	#6 – 14	#8 x 1-1/2	20	200	2000
11011	TC Commercial Drywall Anchors	5/8" – 3/4"	5/16"	#6 – 14	no screws	100	1000	5000
50325	TC Commercial Drywall Anchors	5/8" – 3/4"	5/16"	#6 – 14	#8 x 1-3/4	5	50	1000
50550	TC Commercial Drywall Anchors	5/8" – 3/4"	5/16"	#6 – 14	#8 x 1-3/4	20	200	2000
11021	TD Double Drywall Anchors	1"	5/16"	#6 – 14	no screws	50	500	2500
11029	T35 Hollow Wall Anchors	1-3/8"	5/16"	#6 – 14	no screws	50	500	2500
11030	T39 Hollow Wall Anchors	1-1/2"	5/16"	#6 – 14	no screws	25	250	1250

* In bags only

Specifications, Listings and Approvals

Materials: Specially formulated grade of inert, self-lubricating, translucent, non-corrodible polypropylene that blends into wall color and texture

Grip Range:

- TA® 1/8"-1/4" – TB® 3/8"-1/2"
- TC® 5/8"-3/4" – TD 1"
- T35 1-3/8" – T39 1-1/2"

Screw Specification: Any sheet metal screw or other screw with a sufficiently long thread (i.e., above the minimum screw thread length, TL, shown in the chart on following page)**

Federal Specification: Type IV anchor in FF-B-588D (superseded)

OSHA standard 29 CFR 1910.1200 and DOT standards are not applicable

****NOTE:** Only the threaded (TL) portion of the screw should be in the anchor itself; any unthreaded shank (S) portion of the screw may be in the fixture or item being anchored, but not in the anchor.

Installation Guide

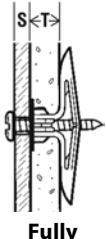
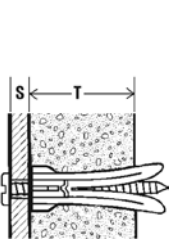
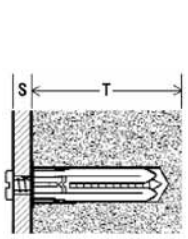
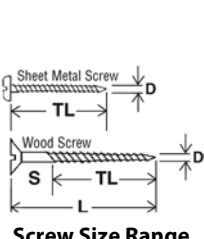
					
	T	T	T	TL [†] – Thread Length L – Screw Length	Drill Dia.*
TA*	1/8" – 1/4"	> 1/4"	1"	D = #8-#12 TL = 1" L = 1" + S	5/16"
TB*	3/8" – 1/2"	> 1/2"	1-3/8"	D = #6-#14 TL = 1-1/4" L = 1-1/4" + S	5/16"
TC*	5/8" – 3/4"	> 3/4"	1-1/2"	D = #6-#14 TL = 1-1/2" L = 1-1/2" + S	5/16"
TD	1"	> 1"	1-7/8"	D = #6-#14 TL = 2" L = 2" + S	5/16"
T35	1-3/8"	> 1-3/8"	2-1/4"	D = #6-#14 TL = 2-1/4" L = 2-1/4" + S	5/16"
T39	1-1/2"	> 1-1/2"	2-1/2"	D = #6-#14 TL = 2-1/2" L = 2-1/2" + S	5/16"

* In very hard materials, like ceramic tile, use 3/8" diameter drill bit.

Installation Instructions



1

Behind wall clearance required:
TA anchor = 1/2" All others = 3/4"

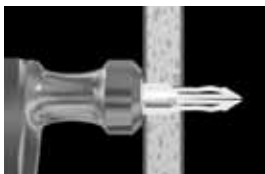

2

1. Drill 5/16" diameter hole. Fold anchor in middle.
2. Insert anchor in hole and tap flush. Clearance needed behind wall: 3/4" for all styles except the TA anchor, which requires only 1/2" .

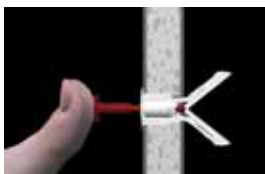

3

3. Insert key to pop anchor open behind hollow wall (not necessary for thick or solid walls). **Do not hammer key.** Remove key.
4. Place item over anchor. Insert screw and tighten until flush with item, then stop. **Do not overtighten.**

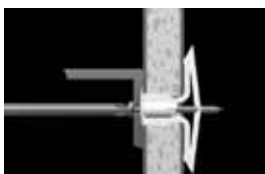

4

† NOTE: Only the threaded portion of the screw should be in the anchor itself; any unthreaded shank portion of the screw may be in the fixture or item being anchored, but not in the anchor.

Ultimate Loads (lb.)

	Anchor		
	TA	TB	TC
Tensile			
1/4" Plywood	124	-	-
1/2" Plywood	-	175	-
3/8" Drywall	-	97	-
1/2" Drywall	-	143	-
5/8" Drywall	-	102*	159
Shear			
1/4" Plywood	265	-	-
3/8" Drywall	-	126	-
1/2" Drywall	126*	167	-
5/8" Drywall	-	214*	237
Screw tested	#8 x 1-1/4"	#8 x 1-1/2"	#8 x 1-3/4"

* #10 screw; used as a wedge anchor (not toggled fully open) in walls thicker than the anchor's grip range

NOTES:

- Holding strength for a TOGGLER plastic hollow-wall anchor varies directly with the strength and condition of the substrate, the screw size, and the extent of the screw engagement, and inversely with variations in hole diameter and the distance of the load from the wall.
- All figures in pounds. Pull-out values based on independent laboratory tests done according to U.S. Government standards. They should be used as guides only and cannot be guaranteed. The age, condition, and capacity of the substrate must be considered.
- Industry standards recommend 1/4 of ultimate test load.
- See MPC technical bulletins for full results of tests and for safety factors that should be applied when evaluating an application, as well as for proper screw sizes and lengths.

Setting Keys



Use red TK setting key for setting TA, TB and TC anchors in hollow walls or ceilings within their grip range.



Use black TKB setting key for setting TD, T35 and T39 anchors in hollow walls or ceilings within their grip range.

TOGGLER® Specialty Anchors

TOGGLER®
HIGH-PERFORMANCE ANCHORS™

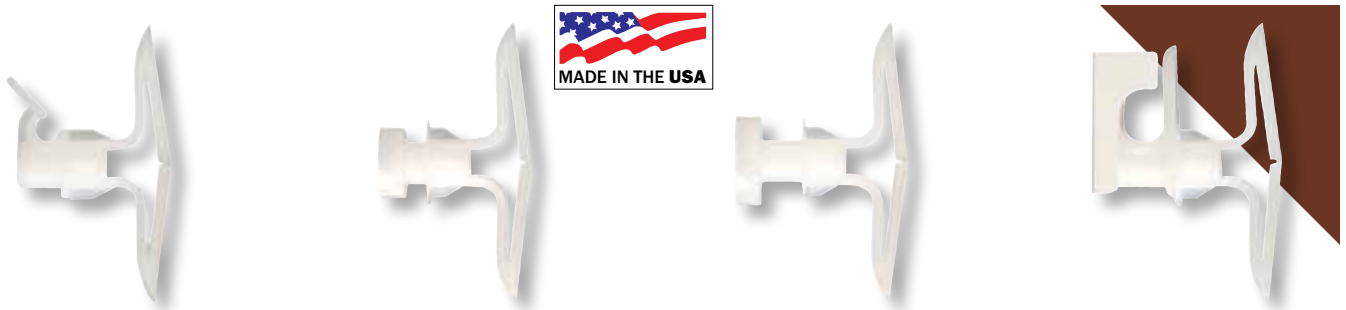

TH® Hook Anchor

- Hang paintings, prints, mirrors, etc. quickly, easily and securely
- Specially-designed, built-in hook holds the weight of the application on the screw, not below it
 - Provides maximum holding and prevents pull-out

TBS1 Shelving Anchor

- No more fumbling with shelving standards
- Built-in spacer prevents the anchor from being jacked out of the wall during installation
- Can be used on warm or wet walls when ventilation is needed behind the installed object

TBS2 Pegboard Anchor

- Built-in spacer holds the pegboard the proper distance from the wall to allow peg hooks to work
- Eliminates need for furring strips, saving time and money
- Allows full use of the pegboard space

TBW Wire Shelf Anchor

- Includes a locking retainer clip so shelves don't tip, even with uneven loads
- Ideal for use with shelving systems like ClosetMaid®
- Perfect for closet systems and kitchen, garage or workshop shelves

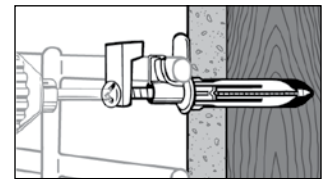
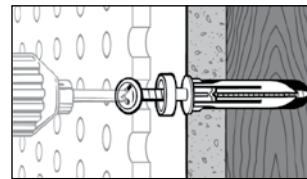
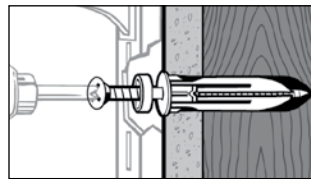
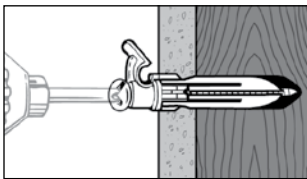
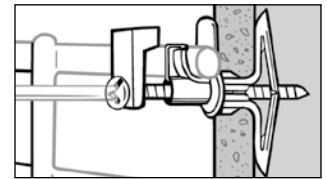
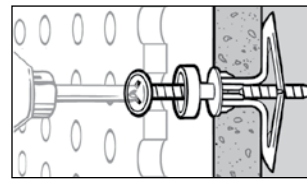
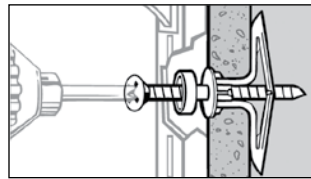
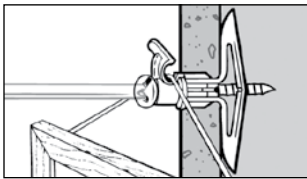

All TOGGLER specialty anchors hold securely, even if you hit a solid area like a stud, or in concrete, brick or stone.

Order Information

Catalog No.	Description	Grip Range/ Wall Depth	Drill Dia.	Recommended Screw	Included Screw Size*	Box / Bag (pcs.)	Inner Carton (pcs.)	Master Carton (pcs.)
11022	TBS2 Pegboard Anchors	3/8" - 1/2"	5/16"	#8 x 1-3/4"	no screws	50	500	2500
50200	TBS2 Pegboard Anchors	3/8" - 1/2"	5/16"	#8 x 1-3/4"	9 #8 x 1-3/4 screws	9	90	1800
11023	TBS1 Shelving Anchors	3/8" - 1/2"	5/16"	#7 x 1-3/4" flat head	no screws	50	500	2500
11024	TBW Wire Shelf Anchors	3/8" - 1/2"	5/16"	#8 x 1-3/4"	no screws	50	500	2500
50250	TBW Wire Shelf Anchors	3/8" - 1/2"	5/16"	#8 x 1-3/4"	5 #8 screws, 5 retainers	5	50	1000
11012	TH Picture Hook Anchors	3/8" - 1/2"	5/16"	#6-14 sheet metal	no screws	100	1000	5000
50225	TH Picture Hook Anchors	3/8" - 1/2"	5/16"	#6-14 sheet metal	5 #8 x 1-1/2 screws	5	50	1000

* Included in bags only.

NOTES:

- Industry safety standards recommend 1/4 of ultimate test load. See MPC technical bulletins for full results of tests and for safety factors that should be applied when evaluating an application, as well as for proper screw sizes and lengths.
- Holding strength for a TOGGLER anchor varies directly with the strength of the wall material, the screw size and the extent of the screw engagement, and inversely with variations in hole diameter and the distance of the load from the wall.

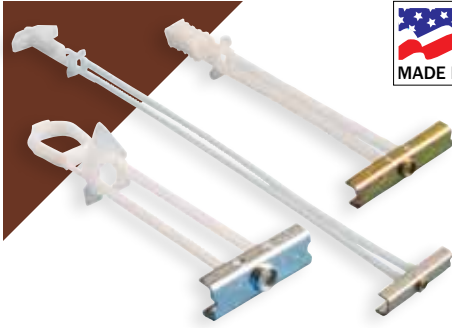

Heavy-duty hollow-wall anchors carry twice the load in a smaller hole than standard anchors

Key Features/Benefits

- **New, patented strap design** with sturdier straps and smaller ratchet interval:
 - Adjusts more precisely and snaps off flush to surface
 - Pushes aside insulation
- Anchor is pre-assembled and ready for immediate use
- **Holds up to twice the load of standard wing toggles**
- Uses a shorter bolt; no need to carry a wing
- Resists vibration and shock
- Pre-installs without fixture or bolt
 - Installs in a significantly smaller hole (up to 50%) than standard wing toggle
 - Maintains integrity of wall, ceiling, or floor, strengthening the fastening
- Does NOT spin when bolt is installed with gun
- New plating† is 7 times more corrosion-resistant than B633-85 Type III, SC1 plating
 - Provides 350 hours salt spray resistance
- Does NOT fall behind wall when bolt is removed; fixture can be removed and reinstalled as often as desired

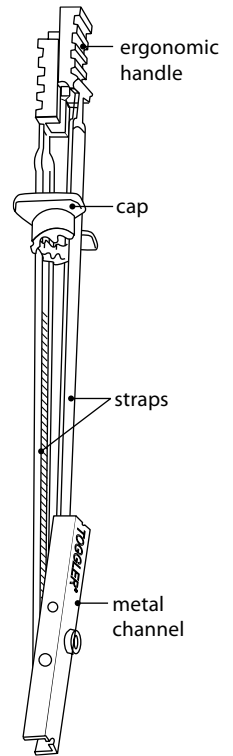

Specifications, Listings and Approvals

Materials*:

- Metal channel: Trivalent (RoHS-compliant) zinc-plated 1010 cold rolled steel or 304 stainless steel
- Straps and handle: High-impact polystyrene*
- Cap: Translucent polypropylene copolymer*

Channel Thread

- UNC or metric machine screw thread

Federal Specifications: Type V anchors FFB588-D (superseded)

* **NOTE:** The plastic straps and cap washer are positioning and retention elements only. They do not otherwise function as anchoring elements. Holding is dependent only on a metal bolt to metal channel connection.

Order Information**

† New plating available only on BA, BB, BM5, BM6, BAL, BBL, BM5L and BM6L.

Catalog Number		Style	Grip Range	Drill Dia.	Thread Size	Bolt Size (In Bags Only)	Box/Bag (pcs.)	Master Carton (pcs.)
Zinc-coated Carbon Steel	304 Stainless Steel							
24013	24020	BA	3/8" – 3-5/8"	1/2"	3/16-24	–	100	1000
25013	25020	BA	3/8" – 3-5/8"	1/2"	3/16-24	–	50	500
50375		BA	3/8" – 3-5/8"	1/2"	3/16-24	3/16-24	10	120
50350	50435	BA	3/8" – 3-5/8"	1/2"	3/16-24	3/16-24	2	200
24014	24021	BB	3/8" – 3-5/8"	1/2"	1/4-20	–	100	1000
25014	25021	BB	3/8" – 3-5/8"	1/2"	1/4-20	–	50	500
50425		BB	3/8" – 3-5/8"	1/2"	1/4-20	1/4-20	10	120
50400	50440	BB	3/8" – 3-5/8"	1/2"	1/4-20	1/4-20	2	200
21017		BE	3/8" – 2-1/2"	3/4"	5/16-18	–	25	250
21015	21022	BC	3/8" – 2-1/2"	3/4"	3/8-16	–	25	250
21016	21023	BD	3/8" – 2-1/2"	3/4"	1/2-13	–	25	250
25029	25030	BM5 Metric	3/8" – 3-5/8"	1/2"	M5 (5 mm)	–	50	500
25024	25026	BM6 Metric	3/8" – 3-5/8"	1/2"	M6 (6 mm)	–	50	500
21031	21032	BM8 Metric	3/8" – 2-1/2"	3/4"	M8 (8 mm)	–	25	250
21035	21036	BM10 Metric	3/8" – 2-1/2"	3/4"	M10 (10 mm)	–	25	250
21049	21059	BAL Long	2" – 9-1/2"	1/2"	3/16-24	–	50	500
21050	21060	BBL Long	2" – 9-1/2"	1/2"	1/4-20	–	50	500
21064	21065	BM5L Metric Long	2" – 9-1/2"	1/2"	M5 (5 mm)	–	50	500
21025	21061	BM6L Metric Long	2" – 9-1/2"	1/2"	M6 (6 mm)	–	50	500

** All bags and boxes must be purchased in master carton quantities, except for stainless steel boxes, long toggle bolts and metric sizes. 10-24 thread = 3/16-24

Ultimate Tensile Pull-Out Values (lb.)

Anchor	UNC Thread	Drill Dia.	1/2" Drywall	5/8" Drywall	*1/2" With 25 Gauge Stud	*5/8" With 25 Gauge Stud	Concrete Block	1/2" Steel Plate	Stainless In 1/2" Steel ³
BA	3/16"-24	1/2"	238	356	412	462	802	918 ¹	1,193 ¹
BB	1/4"-20	1/2"	265	356	425	464	1,080	1,283 ²	1,735 ¹
BE	5/16"-18	3/4"	270	480	439	477	1,400	1,680	2,118
BC	3/8"-16	3/4"	275	576	466	488	1,745	1,692	2,523 ¹
BD	1/2"-13	3/4"	275	576	468	513	**2,038 ²	2,605	3,150

* Failure measured as breakage of drywall portion

** Failure of block

- 1 Stainless steel bolts used
- 2 Hardened bolts used
- 3 Stainless steel channel tested with stainless bolts in 1/2" steel plate

Ultimate Shear Values (lb.)

Anchor	UNC Thread	Drill Dia.	1/2" Drywall	5/8" Drywall
BA	3/16"-24	1/2"	247	298
BB	1/4"-20	1/2"	241	324
BC	3/8"-16	3/4"	292	406

- Industry standards recommend 1/4 of ultimate test load.
- Holding strength for a SNAPTOGGLE heavy-duty hollow-wall anchor varies directly with the strength and condition of the substrate and the bolt size, and inversely with variations in hole diameter and the distance of the load from the wall.
- All figures in pounds. Pull-out values based on independent laboratory tests done according to U.S. Government standards. They should be used as guides only and cannot be guaranteed. The age, condition, and capacity of the substrate must be considered.

Installation Instructions

Minimum bolt length (BL) = thickness of wall or ceiling (W) + thickness of item being fastened (T) + 1/2"

Minimum clearance behind wall (C) : 1-7/8"

Minimum wall or ceiling thickness (W): 3/8"

Maximum wall or ceiling thickness (W):

- 3-5/8" for BA & BB anchors
- 2-1/2" for BC, BD & BE anchors
- 9-1/2" for BAL & BBL anchors

1. Drill appropriate size hole per charts above. Hold metal channel flat alongside plastic straps and slide channel through the hole.
2. Hold ends of straps together between thumb and forefinger and pull toward you until channel rests behind wall. Ratchet cap along straps with other hand until flange of cap is flush with wall.
3. Place thumb between straps at wall. Push thumb side to side, snapping off straps level with flange of cap.
4. Place item over flange. Insert bolt and tighten until snug against item, then stop. Use machine screw or bolt to match thread in metal channel.

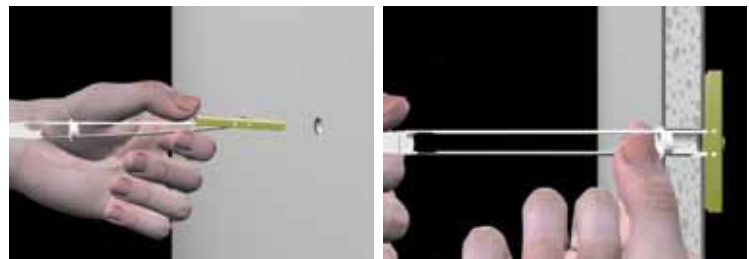
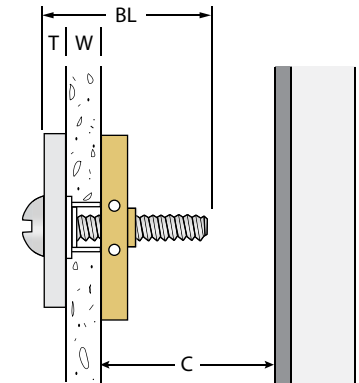

1

2

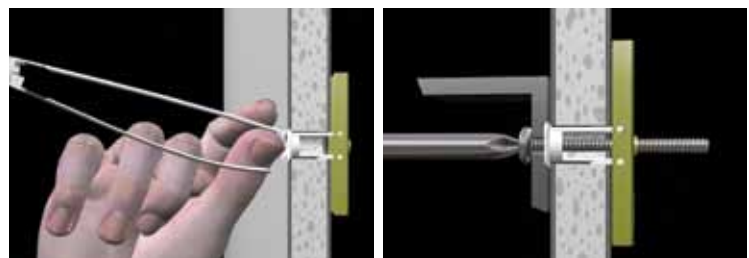

3

4

NOTES:

- Gently hand engage at least one thread of bolt with channel before using screw gun to avoid cross threading the bolt.
- For maximum shear holding, orient channels vertically to floor.
- Use hardened or stainless bolts for maximum weight load.
- Enlargement of specified insertion holes size will reduce anchor effectiveness.
- Remove anchor by removing bolt, inserting screwdriver and popping channel behind wall off plastic straps with a sharp blow.
- All SNAPTOGGLE anchors meet the requirements of Type V anchors in Federal Specification FFB-588-D (superseded).
- All bolts and threaded rods used with SNAPTOGGLE anchors must meet ANSI or HR 3000 standards to ensure safety and effectiveness.

Standard Wing Toggles

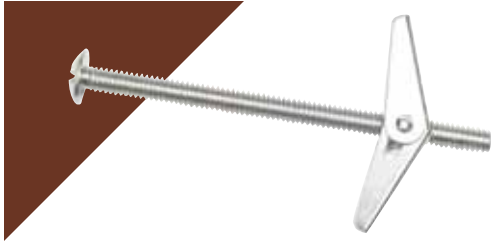

Key Features/Benefits

- Two-part assembly consisting of a machine bolt and a spring wing toggle
- Wing toggle spreads load over a wide area
- Snap-open action eases installation
- Zinc-plated carbon steel only

Specifications, Listings and Approvals

Materials:

- Wings – AISI 1010
- Bolt – Carbon Steel

Finish: Zinc Plated ASTM B633

Toggle Bolts: Allowable Load Capacities In Hollow Concrete Masonry

Anchor Dia. (in.)	Drill Dia. (in.)	Allowable Load [†] (lb.)	
		Tension	Shear
1/8	1/2	45	43
3/16	9/16	85	80
1/4	11/16	85	130
3/8	1	200	150

†1,500 psi Grade N, Type II medium and normal, Type N mortar min.

Order Information

Catalog Number	Bolt Size (in.)	Drill Dia. (in.)	Thread Size UNC	Quantity	
				Box	Carton
Mushroom Head Combo					
TBM1820	1/8 x 2	1/2	6-32	50	500
TBM1830	1/8 x 3	1/2	6-32	50	500
TBM1840	1/8 x 4	1/2	6-32	50	500
TBM3620	3/16 x 2	9/16	10-24	50	500
TBM3630	3/16 x 3	9/16	10-24	50	500
TBM3640	3/16 x 4	9/16	10-24	50	500
TBM3650	3/16 x 5	9/16	10-24	50	500
TBM3660	3/16 x 6	9/16	10-24	50	400
TBM1430	1/4 x 3	11/16	1/4-20	50	400
TBM1440	1/4 x 4	11/16	1/4-20	50	400
TBM1450	1/4 x 5	11/16	1/4-20	50	400
TBM1460	1/4 x 6	11/16	1/4-20	50	400
TBM3830	3/8 x 3	1	3/8-16	25	200
TBM3840	3/8 x 4	1	3/8-16	25	200
TBM3850	3/8 x 5	1	3/8-16	25	200
TBM3860	3/8 x 6	1	3/8-16	25	200

Allowable Load Capacities In Wallboard

Bolt Dia.	1/8"		3/16"		1/4"		5/16"		3/8"		1/2"	
	Tension (lb.)	Shear (lb.)	Tension (lb.)	Shear (lb.)	Tension (lb.)	Shear (lb.)	Tension (lb.)	Shear (lb.)	Tension (lb.)	Shear (lb.)	Tension (lb.)	Shear (lb.)
3/8	30	30	35	35	55	55	60	60	60	60	65	65
1/2	35	35	45	45	60	60	65	65	65	65	80	80
5/8	45	45	60	60	65	65	70	70	75	75	95	95
3/4	55	55	70	70	75	75	80	80	85	85	100	100

Hollow Wall Anchors

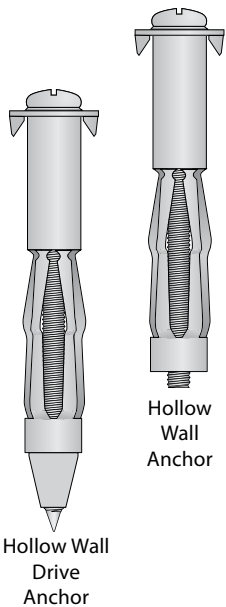

Key Features/Benefits

- Greater holding power than nails or screws in hollow walls
- Fixtures can be removed or replaced without removing anchor
- Hollow wall drive anchors do not require pre-drilling – drive into walls in seconds

Specifications, Listings and Approvals

Materials:

- Anchor Body AISI 1010
- Machine Screw Carbon Steel

Finish: Zinc plated to ASTM B633



Order Information

Hollow Wall Anchors						
Catalog No.	Description	Anchor Dia. (in.)	Drill Dia. (in.)	Wall Thickness	Quantity	
					Box	Carton
HWXS18	Hollow Wall Anchor – Extra Short	1/8	5/16	0 – 1/4"	100	2000
HWS18	Hollow Wall Anchor – Short	1/8	5/16	1/8" – 1/2"	100	2000
HWS36	Hollow Wall Anchor – Short	3/16	3/8	1/8" – 5/8"	50	1000
HWS14	Hollow Wall Anchor – Short	1/4	7/16	1/8" – 5/8"	50	500
HWL18	Hollow Wall Anchor – Long	1/8	5/16	5/8" – 7/8"	100	1000
HWL36	Hollow Wall Anchor – Long	3/16	3/8	5/8" – 1-1/4"	50	500
HWL14	Hollow Wall Anchor – Long	1/4	7/16	5/8" – 1-1/4"	50	500
HWXL36	Hollow Wall Anchor – Extra Long	3/16	3/8	1-1/4" – 1-3/4"	25	250

Hollow Wall Drive Anchors						
Catalog No.	Description	Anchor Dia. (in.)	Drill Dia. (in.)	Wall Thickness	Quantity	
					Box	Carton
HWLD18	Hollow Wall Drive Anchor - Long Drive	1/8	5/16	5/8" – 3/4"	100	1000
HWSD18	Hollow Wall Drive Anchor - Short Drive	1/8	5/16	1/8" – 1/2"	100	1000

Hollow Wall Anchor and Drive Anchor Allowable Load Capacities In Wallboard

Anchor Dia. (in.)	1/8		3/16		1/4	
	Tension (lb.)	Shear (lb.)	Tension (lb.)	Shear (lb.)	Tension (lb.)	Shear (lb.)
Wallboard Thickness (in.)						
3/8	20	25	25	35	25	35
1/2	40	40	45	45	50	50
5/8	40	45	50	55	55	55
3/4	45	45	50	55	60	60

Wall Anchors



Key Features/Benefits

- Self-drilling – no pre-drilled hole required
- Two styles available:
 - MINI: 0.4" dia. head, 1/4" dia., 1.25" length
 - Regular: 0.62" dia. head; 5/16" dia., 1-5/8" length
- Higher load-bearing capability and screw size range than other self-drilling drywall anchors
- **Built-in "positive-stop"** prevents over-driving the anchor when using a screw gun or hand drill
- **Activate and lock with an audible "POP"**, providing positive feedback that they are installed correctly
- Resist vibration and shock
- Provide high pull-out resistance
 - Do not back out of the wall when the screw is removed
 - Can be removed easily, without damaging wall
- Unique tip prevents "walking" to ensure accurate and easy drilling

Specifications, Listings and Approvals

Material: Injection-molded, glass-filled nylon (proprietary thermoplastic alloy)

Screw Sizes Per Anchor

Sheet metal screw (SMS), fully threaded in anchor		
	MINI SnapSkru	Regular Snapskru
Dia.	#6 (preferred), #7, #8	#6, #7, #8 (preferred), #10
Min. Length	1" + thickness of item being anchored	1-1/4" + thickness of item being anchored

NOTE: Only the threaded portion of the screw should be in the anchor itself; any unthreaded shank portion of the screw may be in the fixture or item being anchored, but not in the anchor.

Order Information

Catalog No.	Description	Included Screw Size In Bag/ Box	Screw Size Range	Drywall Thickness	Box / Bag (pcs.)	Inner Carton (pcs.)	Master Carton (pcs.)
30010	SP	100 #8 x 1-1/2" Combo Screws	#6 – #10	3/8" – 5/8"	100	1000	3000
30011	SP	No Screws	#6 – #10	3/8" – 5/8"	100	1000	3000
30012	SP	50 #8 x 1-1/2" Combo Screws	#6 – #10	3/8" – 5/8"	50	500	2500
50100	SP	4 #8 x 1-1/2" Combo Screws	#6 – #10	3/8" – 5/8"	4	40	800
50125	SP	20 #8 x 1-1/2" Combo Screws	#6 – #10	3/8" – 5/8"	20	200	2000
30030	MINI SPM	100 #6 x 1-1/4" Combo Screws	#6 – #8	3/8" – 5/8"	100	1000	5000
30031	MINI SPM	No Screws	#6 – #8	3/8" – 5/8"	100	1000	5000
30032	MINI SPM	50 #6 x 1-1/4" Combo Screws	#6 – #8	3/8" – 5/8"	50	500	2500
50150	MINI SPM	6 #6 x 1-1/4" Combo Screws	#6 – #8	3/8" – 5/8"	6	60	1200
50175	MINI SPM	25 #6 x 1-1/4" Combo Screws	#6 – #8	3/8" – 5/8"	25	250	2500

Installation Instructions

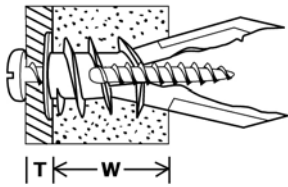

(W) Wall thickness
(T) Item thickness
(S) Screw length = T + 1"

Minimum Drywall Thickness: 3/8"

Maximum Drywall Thickness: 5/8"

Minimum Clearance:

- 5/8" behind 1/2" drywall
- 1/2" behind 5/8" drywall

Additional clearance may be needed for extra-long screws.

Tools Needed: Screw gun with #2 phillips bit (or #2 phillips screwdriver, or electric drill with clutch mechanism and #2 bit)

1. Press tip of SnapSkru anchor into drywall using #2 phillips screwdriver or screw gun. Drive anchor clockwise into drywall until anchor stops flush with the outer wall surface.

TIP: To keep anchor in precise position during installation (critical for aligning several anchors), push tip of screwdriver into drywall to mark insertion point.

2. Place item over anchor and insert any fully-threaded screw of appropriate size (see chart on previous page).

3. Tighten screw flush with item. The screw pops open the anchor, locking it on the wall and holding the gypsum board in compression. This reinforces the wall, increasing its holding power significantly.

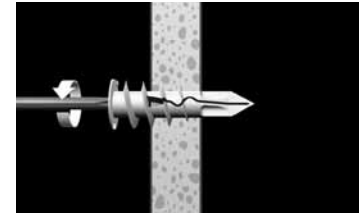

1

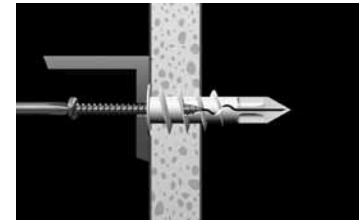

2

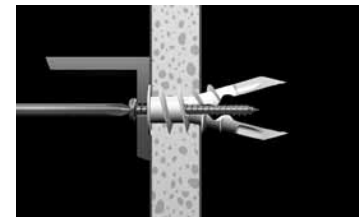

3

Ultimate Tensile (lb.)*

	MINI	Regular
3/8" Drywall	57	57
1/2" Drywall	65	79
5/8" Drywall	95	135
Screw tested:	#6 x 1-1/4"	#8 x 1-1/2"

Ultimate Shear (lb.)*

	MINI	Regular
3/8" Drywall	105	108
1/2" Drywall	131	149
5/8" Drywall	175	178
Screw tested:	#6 x 1-1/4"	#8 x 1-1/2"

*NOTES:

- Ultimate tensile and shear values shown are to be used as a guide only. Industry safety standards recommend using only 1/4 of ultimate tensile and shear values as the maximum load per anchor.
- Ultimate tensile and shear values for a SnapSkru anchor vary directly with the strength and thickness of the wall material, the screw size, and the extent of screw engagement.
- The age, condition and capacity of the substrate must be considered.



Specifications, Listings and Approvals

Material: Specially formulated, inert grade of self-lubricating, translucent, non-corrodible polypropylene

Screw Size Range: See Order Information table below

OSHA standard 29 CFR 1910.1200 and **DOT** standards are not applicable

MSDS not required

Extends up to the entire length of screw to provide high holding strength in solid or hollow walls

Key Features/Benefits

- Completely solid anchor with circular cross-section
 - Causes all forces from mating screw to be fully transmitted to the wall of the hole
 - Provides full compressive holding over entire length of screw
- Two styles available
 - **Flanged** for use where a cavity is anticipated (drywall, hollow brick, etc.).
 - **Unflanged** for push-through mounting
- Can be more closely spaced than other solid-wall anchors
- Fins prevents spinning and countersink even when using a screw gun
- Anchor bonds screw to concrete, brick and stone, sealing the hole against moisture
- **Versatile** – holds securely even in hollow walls and ceilings
- Non-corrodible – safely used with stainless steel screws in corrosive environments
- Screws anchored with ALLIGATOR anchors have very high residual holding strength and low susceptibility to failure by vibration or shock loads
- Screw can be removed and reinserted in same anchor with little or no damage and without loss of holding power

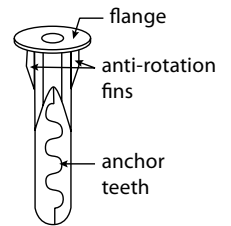

Flanged Style

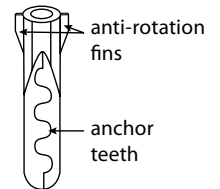

Unflanged Style (Flush Mount)

Order Information

Catalog No.	Description	Flange	Min. Wall Thickness	Drill Dia.	Screw Size Range	Included Screw Size*	Box / Bag (pcs.)	Inner Carton (pcs.)	Master Carton (pcs.)
13103	AF5	Yes	1/4"	3/16"	#4 – 3/16" SMS	No Screw	200	2000	10000
50445	AF5	Yes	1/4"	3/16"	#4 – 3/16" SMS	#8 X 1-1/4	6	60	1200
50450	AF5	Yes	1/4"	3/16"	#4 – 3/16" SMS	#8 X 1-1/4	20	200	2000
13101	AF6	Yes	3/8"	1/4"	#6 – 1/4" lag	No Screw	100	1000	5000
50470	AF6	Yes	3/8"	1/4"	#6 – 1/4" lag	#10 X 1-1/2	6	60	1200
50475	AF6	Yes	3/8"	1/4"	#6 – 1/4" lag	#10 X 1-1/2	20	200	2000
13102	AF8	Yes	1/2"	5/16"	#8 – 5/16" lag	No Screw	100	1000	5000
50490	AF8	Yes	1/2"	5/16"	#8 – 5/16" lag	#12 X 1-3/4	6	60	1200
50500	AF8	Yes	1/2"	5/16"	#8 – 5/16" lag	#12 X 1-3/4	20	200	2000
13106	A5	No	N/A	3/16"	#4 – 3/16" SMS	No Screw	200	2000	10000
13104	A6	No	N/A	1/4"	#6 – 1/4" lag	No Screw	100	1000	5000
50460	A6	No	N/A	1/4"	#6 – 1/4" lag	#10 X 1-1/2	6	60	1200
13105	A8	No	N/A	5/16"	#8 – 5/16" lag	No Screw	100	1000	5000
13107	A10	No	N/A	3/8"	#10 – 3/8" lag	No Screw	50	500	2500
50510	A10	No	N/A	3/8"	#10 – 3/8" lag	#14 X 2-1/4	4	40	800

* In bags only. SMS: Sheet Metal Screw.

Standard Anchoring Guidelines†

Anchor	Anchor and Drill Dia.	Screw Sizes (D)	Min. Screw Thread Length (TL)	Anchor Length (AL)	Min. Hole Depth (HD)	Min. Wall Thickness (W)
AF5	3/16"	#4 – #9	1-3/16"+ L	1"	1-1/2"	1/4"
A5			1-1/8"+ L	15/16"		N/A
AF6	1/4"	#6 – #12	1-3/8"+ L	1-3/16"	1-3/4"	3/8"
A6			1-5/16"+ L	1-1/8"		N/A
AF8	5/16"	#8 – #14	1-13/16"+ L	1-5/8"	2-1/4"	1/2"
A8			1-3/4"+ L	1-9/16"		N/A
A10	3/8"	#10 – #18	2"+ L	1-7/8"	2-1/2"	N/A

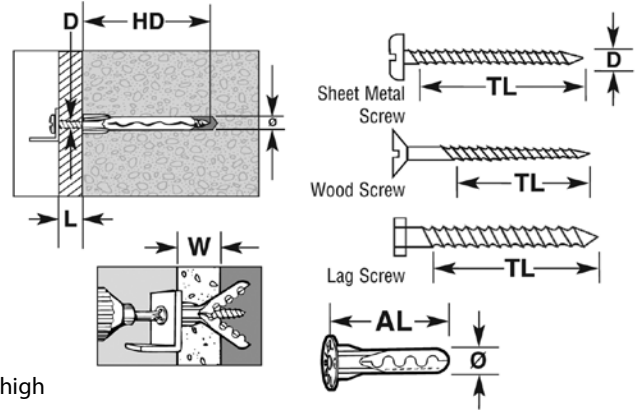

† NOTES:

- The anchors should be installed at least 1.5" from an unsupported edge in high strength materials, because of the high compression forces exerted by the screw.
- It is recommended that the screw be completely set without pause, because of the remodeling of the anchor under pressure.
- Use hardened or stainless steel screws to increase shear and tensile strength.
- With lag bolts, do not permit the unthreaded portion to enter the anchor. Any unthreaded portion should remain in the item being anchored.
- Use hex head screws wherever possible, because of high back pressure.
- When used in porous masonry materials such as low compressive strength concrete, aerated concrete, small unsupported blocks, or brick, it is recommended that the screw size not exceed those given in the chart.

Maximum Strength Anchoring Guidelines††

Anchor	Drill Size	Screw Type	Min. Embed. Thread Length	Minimum Hole Depth
AF5 / A5 (3/16")	3/16"	#10 SMS	2"	2-1/2"
AF6 / A6 (1/4")	1/4"	#14 Lag	2-1/4"	2-3/4"
AF8 / A8 (5/16")	5/16"	5/16" Lag	2-1/2"	3-1/4"
A10 (3/8")	3/8"	3/8" Lag	3"	3-1/2"

†† NOTES:

- The screw diameter changes the compressive force of the anchor assembly. This allows one diameter anchor to work in all kinds of substrates:
 - Small diameter screws should be used in low-strength, easily compressed substrates.
 - Large diameter screws should be used in high-strength substrates.
- Drill insertion holes twice anchor length. Drilled hole length + thickness of fixture should exceed screw length by a minimum of 1/2".

Ultimate Tensile Pull-Out Values (lb.)

Anchor	Anchor Dia.	Drill Dia.	Screw Description	1/2" Drywall	3500 psi Concrete	Screw Description	4000 psi Concrete
A5/AF5	3/16"	3/16"	#8 SMS	57	544	#10 SMS	2,316
A6/AF6	1/4"	1/4"	#10 SMS	69	675	#14 SMS	2,633
A8/AF8	5/16"	5/16"	#12 SMS	85	1,025	5/16" Lag	3,083
A10	3/8"	3/8"	#14 SMS	N/A	1,168	3/8" Lag	3,570

Ultimate Shear (lb.)

Anchor	Anchor Dia.	Drill Dia.	Screw Description	1/2" Drywall
AF5	3/16"	3/16"	#8 SMS	125
AF6	1/4"	1/4"	#10 SMS	153
AF8	5/16"	5/16"	#12 SMS	171
A10	3/8"	3/8"	N/A	N/A

NOTES:

- Industry standards recommend 1/4 of ultimate test load.
- Holding strength for ALLIGATOR solid-wall anchors varies directly with the strength and condition of the substrate, the screw size, and the extent of the screw engagement, and inversely with variations in hole diameter and the distance of the load from the wall.
- All figures in pounds. Pull-out values based on independent laboratory tests done according to U.S. Government standards. They should be used as guides only and cannot be guaranteed. The age, condition, and capacity of the substrate must be considered.

Installation Instructions



1

1. Drill hole same diameter as anchor and twice anchor length. (Drilled hole length plus thickness of fixture should exceed screw length by a minimum of 1/2".)



2

Push in anchor and tap flush.

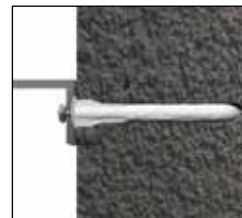

3

2. Place item over anchor. Insert screw and tighten flush with item.
3. Anti-rotation fins* prevent spinning while the anchor expands along the screw in solid walls, up to 2 times its original length.

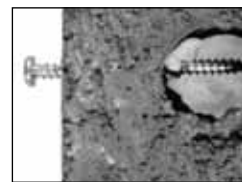

4

4. In unexpected cavities or in hollow walls, the screw thread and anchor teeth lock together to resist vibration and shock.

*NOTE: The anti-rotation fins on the head will cut into drywall to prevent the anchor from spinning.

SDS Carbide-Tipped Drill Bits

Design Optimizes Drilling Operations

Key Features and Benefits

- Centering tip allows exact hole placement
 - Greatly reduces bit walking
- Large relief cut in fluting below carbide reduces friction during dust removal, reducing heat and increasing bit life
- Box fluting
 - Speeds dust evacuation
 - Decreases vibration back into the tool
 - Extends tool life
 - Increases operator comfort during drilling



Order Information SDS-plus® Carbide-Tipped Drill Bits



Catalog Number	Description	Overall Length (in.)	Usable Length (in.)	Qty.
SDS5324	5/32 x 4	4	2	1
SDS5326	5/32 x 6	6	4	1
SDS3164	3/16 x 4	4	2	1
SDS3166	3/16 x 6	6	4	1
SDS3168	3/16 x 8	8	6	1
SDS31612	3/16 x 12	12	10	1
SDS1440	1/4 x 4	4	2	1
SDS1460	1/4 x 6	6	4	1
SDS1480	1/4 x 8	8	6	1
SDS1411	1/4 x 11	11	9	1
SDS1420	1/4 x 20	20	18	1
SDS5166	5/16 x 6	6	4	1
SDS5168	5/16 x 8	8	6	1
SDS3860	3/8 x 6	6	4	1
SDS3880	3/8 x 8	8	6	1
SDS3812	3/8 x 12	12	10	1
SDS7166	7/16 x 6	6	4	1
SDS1260	1/2 x 6	6	4	1
SDS1210	1/2 x 10	10	8	1
SDS1212	1/2 x 12	12	10	1
SDS1218	1/2 x 18	18	16	1
SDS1224	1/2 x 24	24	22	1
SDS9166	9/16 x 6	6	4	1
SDS91612	9/16 x 12	12	10	1
SDS5860	5/8 x 6	6	4	1
SDS5880	5/8 x 8	8	6	1
SDS5812	5/8 x 12	12	10	1
SDS5818	5/8 x 18	18	16	1
SDS5824	5/8 x 24	24	22	1
SDS3480	3/4 x 8	8	6	1
SDS3412	3/4 x 12	12	10	1
SDS3418	3/4 x 18	18	16	1
SDS7880	7/8 x 8	8	6	1
SDS7812	7/8 x 12	12	10	1
SDS7818	7/8 x 18	18	16	1
SDS1012	1 x 12	12	10	1
SDS1018	1 x 18	18	16	1

Order Information: SDS Bulk Quality Economy Bits

Catalog Number	Description	Overall Length (in.)	Usable Length (in.)	Qty.
6SDS3166E	3/16 x 6	6	4	25
6SDS1460E	1/4 x 6	6	4	25
6SDS5166E	5/16 x 6	6	4	25
6SDS3860E	3/8 x 6	6	4	25

Order Information: SDS Hex For Tapcon®/UltraCon® Tools

Catalog Number	Description	Overall Length (in.)	Usable Length (in.)	Qty.
SDSH5325	5/32 x 5	5	2	1
SDSH5327	5/32 x 7	7	4	1
SDSH3165	3/16 x 5	5	2	1
SDSH3167	3/16 x 7	7	4	1

Order Information: Taper Bits For Tapcon/UltraCon Tools

Catalog Number	Description	Overall Length (in.)	Usable Length (in.)	Pieces/Pkg.
TAP53232	5/32 x 3-1/2	3-1/2	2-1/4	1
TAP53242	5/32 x 4-1/2	4-1/2	2-1/2	1
TAP31642	3/16 x 4-1/2	4-1/2	2-1/2	1
TAP31652	3/16 x 5-1/2	5-1/2	3-3/4	1

SDS Carbide-Tipped Drill Bits

Order Information:

SDS-max® Cutter* Carbide-Tipped Drill Bits



Catalog Number	Description	Overall Length	Usable Length	Qty.
SDSMHQ1213	1/2 x 13 (2 cutter)	13	8	1
SDSMHQ1221	1/2 x 21 (2 cutter)	21	16	1
SDSMHQ91621	9/16 x 21 (2 cutter)	21	16	1
SDSMHQ5813	5/8 x 13 (4 cutter)	13	8	1
SDSMHQ5821	5/8 x 21 (4 cutter)	21	16	1
SDSMHQ3413	3/4 x 13 (4 cutter)	13	8	1
SDSMHQ3421	3/4 x 21 (4 cutter)	21	16	1
SDSMHQ3436	3/4 x 36 (4 cutter)	36	30	1
SDSMHQ7813	7/8 x 13 (4 cutter)	13	8	1
SDSMHQ7821	7/8 x 21 (4 cutter)	21	16	1
SDSMHQ1013	1 x 13 (4 cutter)	13	8	1
SDSMHQ1021	1 x 21 (4 cutter)	21	16	1
SDSMHQ1036	1 x 36 (4 cutter)	36	30	1
SDSMHQ11821	1-1/8 x 21 (4 cutter)	21	16	1
SDSMHQ11423	1-1/4 x 23 (4 cutter)	23	18	1
SDSMHQ13823	1-3/8 x 23 (4 cutter)	23	18	1
SDSMHQ11223	1-1/2 x 23 (4 cutter)	23	18	1

* Cutters makes bit rebar-resistant

NOTE: Made in Germany. USA-made available upon request.

Order Information:

Standard Spline Carbide-Tipped Drill Bits



Catalog Number	Description	Overall Length	Usable Length	Qty.
SPL3813	3/8 x 13	13	8	1
SPL3816	3/8 x 16	16	11	1
SPL1213	1/2 x 13	13	8	1
SPL1216	1/2 x 16	16	11	1
SPL1222	1/2 x 22	22	17	1
SPL91613	9/16 x 13	13	8	1
SPL5810	5/8 x 10	10	5	1
SPL5813	5/8 x 13	13	8	1
SPL5816	5/8 x 16	16	11	1
SPL5822	5/8 x 22	22	17	1
SPL3413	3/4 x 13	13	8	1
SPL3416	3/4 x 16	16	11	1
SPL3422	3/4 x 22	22	17	1
SPL7816	7/8 x 16	16	11	1
SPL7822	7/8 x 22	22	17	1
SPL1016	1 x 16	16	11	1
SPL1022	1 x 22	22	19	1
SPL11822	1-1/8 x 22	22	19	1
SPL11416	1-1/4 x 16	16	11	1
SPL13816	1-3/8 x 16	16	11	1

ANSI B212.15 Standard Tolerances

Dia. (in.)	Min. (in.)	Max. (in.)
5/32	0.165	0.171
3/16	0.198	0.206
1/4	0.260	0.268
5/16	0.327	0.335
3/8	0.390	0.398
7/16	0.456	0.468
1/2	0.520	0.530
9/16	0.582	0.592
5/8	0.650	0.660
11/16	0.713	0.723
3/4	0.775	0.787
7/8	0.905	0.917
1	1.030	1.042
1-1/8	1.160	1.175
1-1/4	1.285	1.300
1-5/16	1.352	1.367
1-3/8	1.410	1.425
1-1/2	1.535	1.550
1-3/4	1.772	1.792

POWER-Sert™ High-Performance Anchors

The ultimate problem fixer

Key Features /Benefits

- Slightly larger bottom lobe creates a keying effect at the deepest anchor point
- Provides high holding values
- Exclusive **FRICION-FIT™** allows immediate fastening of fixture while epoxy cures[†]
- No need to move equipment or fixtures to be fastened – ideal for in-place use^{††}
- Easy installation – no special tools required
- Close edge distance and spacing
- Shallow embedment
 - Helps avoid rebar and drill-through
 - Epoxy bond and shallow embedment minimize effects of cone failure
- **Vibration-resistant** – epoxy bond withstands more seismic vibration loading than most standard mechanical anchors



WARNING: NSTB safety recommendations **prohibit** the use of adhesive anchors in sustained overhead load anchoring applications

NOTES:

- † FRICION-FIT™ without full epoxy cure is for light-duty temporary holding only and produces far less than advertised ultimate holding values.
- †† Pre-drilled hole in fixture must be large enough to accommodate correct size of carbide-drill bit.

Order Information

Catalog Number			Mating Bolt Size (in.)	Anchor Size (in.)	Quantity	
Carbon Steel	Stainless Steel				Box	Carton
	303	316				
PS2-14	PSS-14	PS6-14	1/4	5/16 x 1-9/16	100	800
PS2-56	PSS-56	PS6-56	5/16	7/16 x 2-3/8	100	800
PS2-38	PSS-38	PS6-38	3/8	1/2 x 2-3/4	50	400
PS2-12	PSS-12	PS6-12	1/2	5/8 x 3-11/16	25	200
PS2-58	PSS-58	PS6-58	5/8	7/8 x 5-3/4	10	80
PS2-34	PSS-34	PS6-34	3/4	1 x 6-1/2	5	40
PS2-1	PSS-1	PS6-1	1	1-1/2 x 8-1/2	5	15

Edge Distance and Spacing Requirements

Catalog No.	Embed. Depth (in.)	Min. Edge Dist. (in.)	Min. Spacing (in.)	Thread Depth (in.)
PS2-14	1-5/8	1-5/8	2-3/8	1/2
PS2-56	2-3/8	2-3/8	4-3/4	3/4
PS2-38	2-3/4	2-3/4	5-1/2	1
PS2-12	3-3/4	3-3/4	7-3/8	1
PS2-58	5-3/4	5-3/4	8-5/8	1-1/2
PS2-34	6-1/2	6-1/2	9-3/4	1-1/2
PS2-1	8-1/2	8-1/2	17	2

Installation Instructions

1. Select the proper size drill bit from the estimating guide. Drill the hole perpendicular to the work surface. To assure full holding power, do not ream the hole or allow the drill to wobble.
2. Thoroughly clean hole with oil-free compressed air and a stiff nylon or wire brush. Repeat cleaning process 3 times. Dust and debris left in hole will significantly reduce the holding capacity of the anchor.
3. Inject Inject-TITE Two-Part Structural Epoxy into hole to approximately 1/3 to half full. Fill from bottom of hole up.
4. Choose a bolt equal in length to the thread depth plus the material depth. Thread bolt into POWER-Sert anchor so that offset is equal to the thickness of material to be fastened. Insert POWER-Sert anchor into hole with slight twisting motion.
5. Drive anchor home with several sharp hammer blows to the head of the nut.
6. Allow epoxy to cure prior to applying maximum load.

NOTE: Always wear safety glasses. Follow the drill manufacturer's safety instructions. Use only solid carbide-tipped drill bits meeting ANSI B212.15 diameter standards.

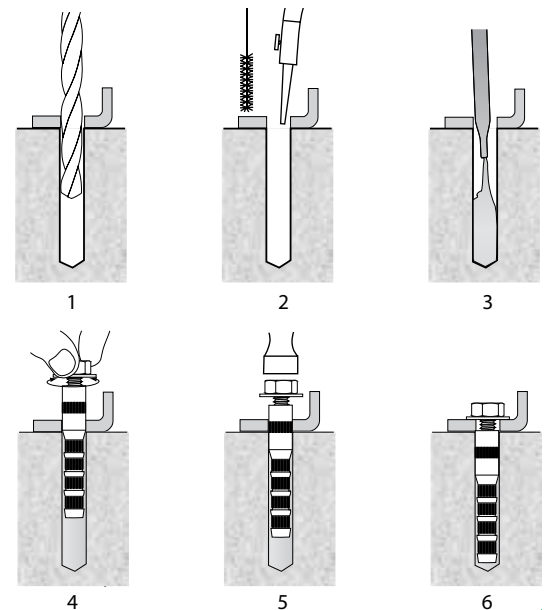

Adhesive Anchors

Estimating Guide

Bolt Size (in.)	Drill Dia. (in.)	Minimum Hole Depth (in.)	Estimated anchors per cartridge		
			8.5/9.3 oz. Cartridge	22oz. Cartridge	28oz. Cartridge
1/4	5/16	1-3/4	165	463	590
5/16	7/16	2-3/4	52	151	192
3/8	1/2	3-1/4	32	86	110
1/2	5/8	4-1/8	19	51	64
5/8	7/8	6-1/4	6	17	22
3/4	1	7-1/2	5	11	14
1	1-1/2	9-1/2	2	4	5

Maximum Tensile Strengths for Static Loads in 4000 psi Concrete

Carbon Steel					Carbon Steel				
Bolt Size – UNC	Drill Dia. (in.)	Hole Depth (in.)	Inject-TITE™ Ultimate Tensile Strength (lb.)	AWF Ultimate Tensile Strength (lb.)	Slam-TITE™ Drill Dia. (in.)	Slam-TITE Hole Depth (in.)	Slam-TITE Capsule Used	Slam-TITE Ultimate Tensile Strength (lb.)	
1/4 – 20	5/16	1-3/4	3380	3543	N/A	N/A	N/A	N/A	
5/16 – 18	7/16	2-3/4	7497	7879	1/2	3	3/8	4879	
3/8 – 16	1/2	3-1/4	10633	9215	1/2	3-1/2	3/8	9597	
1/2 – 13	5/8	4-1/8	15105	13114	5/8	4-1/4	1/2	13142	
5/8 – 11	7/8	6-1/4	26298	26298	7/8	6-1/4	7/8	27087	
3/4 – 10	1	7-1/2	46000	32430	1	7	7/8	–	
1 – 8	1-1/2	9-1/2	64000	–	1-1/2	9	1	–	
303 Stainless Steel					303 Stainless Steel				
Bolt Size – UNC	Drill Dia. (in.)	Hole Depth (in.)	Inject-TITE™ Ultimate Tensile Strength (lb.)	AWF Ultimate Tensile Strength (lb.)	Slam-TITE™ Drill Dia. (in.)	Slam-TITE Hole Depth (in.)	Slam-TITE Capsule Used (in.)	Slam-TITE Ultimate Tensile Strength (lb.)	
1/4 – 20	5/16	1-3/4	3380	3203	N/A	N/A	N/A	N/A	
5/16 – 18	7/16	2-3/4	7197	7606	1/2	3	3/8	6570	
3/8 – 16	1/2	3-1/4	9925	9379	1/2	3-1/2	3/8	9679	
1/2 – 13	5/8	4-1/8	14805	15650	5/8	4-1/4	1/2	15105	
5/8 – 11	7/8	6-1/4	25771	26298	7/8	6-1/4	7/8	25771	
3/4 – 10	1	7-1/2	46000	32430	1	7	7/8	–	
1 – 8	1-1/2	9-1/2	64000	–	1-1/2	9	1	–	
316 Stainless Steel					316 Stainless Steel				
Bolt Size – UNC	Drill Dia. (in.)	Hole Depth (in.)	Inject-TITE™ Ultimate Tensile Strength (lb.)	AWF Ultimate Tensile Strength (lb.)	Slam-TITE™ Drill Dia. (in.)	Slam-TITE Hole Depth (in.)	Slam-TITE Capsule Used (in.)	Slam-TITE Ultimate Tensile Strength (lb.)	
1/4 – 20	5/16	1-3/4	3162	2916	N/A	N/A	N/A	N/A	
5/16 – 18	7/16	2-3/4	7634	7552	1/2	3	3/8	6570	
3/8 – 16	1/2	3-1/4	10142	9379	1/2	3-1/2	3/8	9679	
1/2 – 13	5/8	4-1/8	13387	16687	5/8	4-1/4	1/2	15105	
5/8 – 11	7/8	6-1/4	26100	28404	7/8	6-1/4	7/8	25771	
3/4 – 10	1	7-1/2	46000	32430	1	7	7/8	–	
1 – 8	1-1/2	9-1/2	64000	–	1-1/2	9	1	–	

NOTES:

- Information provided only for the use of a qualified design engineer. Use of technical data by persons not qualified could cause serious damage, injury, or even death.
- Ultimate values are shown. For static loads, use one-fourth of the maximum tensile and shear capacities for the recommended 4:1 safety factor.
- Install POWER-Sert™ anchors only with epoxy supplied with anchors or Wej-It® Fastening Systems epoxy products.
- Use cure times recommended by epoxy manufacturer before applying full load to anchor.

Adhesive Anchors



Features/Key Benefits

- **Three varieties available (see listed pages for specifications, ordering and technical information)**
 - All-Weather Formula (p. 49)
 - Fast Set (p. 52) – ICC-ES ESR 2621 approved
 - Standard Set (p. 54)
- Fit in standard 10" dispensing tools (see accessories below)
- Can be used with nylon or stainless steel screens in hollow wall applications to increase strength (see selection below)

Minimum Cure Times²

Min. Substrate Temp.	Cure Time ¹			Minimum Cure Time ¹		
	AWF Epoxy	Standard Set Epoxy	Fast Set Epoxy	AWF Epoxy	Standard Set Epoxy	Fast Set Epoxy
40°F (5°C)	90 min	F ³	48 hrs	N/A	F ³	24 hrs
65°F (18°C)	45 min	48 hrs	36 hrs	N/A	24 hrs	8 hrs
70°F (21°C)	35 min	36 hrs	24 hrs	N/A	12 hrs	2.5 hrs
80°F (27°C)	30 min	24 hrs	12 hrs	N/A	6 hrs	2 hrs
100°F (38°C)	25 min	12 hrs	6 hrs	N/A	4 hrs	1 hr

1. Cure Time is time required before epoxy reaches ultimate strength. Minimum Cure Time is the minimum time required before the design or allowable load may be applied. AWF epoxy must COMPLETELY cure before loads are applied, so it has no "minimum" cure time.
2. Anchors are to be undisturbed during the minimum cure time.
3. "F" indicates Fast Set is recommended.

WARNING: NSTB safety recommendations **prohibit** the use of adhesive anchors in sustained overhead load anchoring applications

Adhesive Accessories

Order Information: 10" Dispensing Tools

Catalog No.	Description	Quantity
EHT10	For 8.5 oz. and 9.3 oz. Cartridges	1
EHT22	For 22 oz. Cartridges	1
EHT28	For 28 oz. Cartridges	1

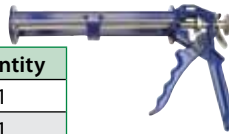

Order Information: Break-Off Mixing Nozzles

Catalog No.	Description	Quantity
ECANZ12	1/2" Nozzle for 8.5 oz. and 9.3 oz. Cartridges	6/Package
ENZ12	1/2" x 18" Nozzle	6/Package
ENZ38	3/8" x 18" Nozzle	6/Package

Order Information: Stud Assemblies – Straight Cut

Catalog Number			Size (in.)	Quantity Box/Cartron
Carbon Steel Grade 2	Stainless Steel			
		304	316	
CS238-S	CSS38-S	CS638-S	3/8 x 5	50/300
CS212-S	CSS12-S	CS612-S	1/2 x 6-1/4	25/150
CS258-S	CSS58-S	CS658-S	5/8 x 7-1/2	10/60
CS234-S	CSS34-S	CS634-S	3/4 x 9-1/2	10/40
CS278-S	CSS78-S	CS678-S	7/8 x 10-1/4	10/40
CS210-S	CSS10-S	•	1 x 11-3/4	5/20
CS2114-S	•	•	1-1/4 x 14	5/20

Nuts and washers included. For use with Inject-TITE epoxy and Slam-TITE™ hammer-in chemical capsules (see page 55). Bevel Cut Stud Assemblies are for Spin-In capsules ONLY – see page 57.

Order Information: Screen Tubes



Catalog No.	Screen	Rod Dia.	Drill Bit Size	Qty.
Nylon Screens for Hollow Wall Applications				
ESCN3814	3/8" x 14"	3/8"	1/2"	1
ESCN1214	1/2" x 14"	1/2"	5/8"	1
ESCN5814	5/8" x 14"	5/8"	3/4"	1
ESCN3414	3/4" x 14"	3/4"	7/8"	1
Stainless Steel Short Screens for Brick and Block				
ESCS3832	3/8 x 3-1/2"	3/8"	1/2"	1
ESCS1232	1/2 x 3-1/2"	1/2"	5/8"	1
Stainless Steel Screens for Brick and Block				
ESCS3860	3/8 x 6"	3/8"	1/2"	1
ESCS3810	3/8 x 10"	3/8"	1/2"	1
ESCS1260	1/2 x 6"	1/2"	5/8"	1
ESCS1210	1/2 x 10"	1/2"	5/8"	1
ESCS5860	5/8 x 6"	5/8"	3/4"	1
ESCS5810	5/8 x 10"	5/8"	3/4"	1
ESCS3410	3/4 x 10"	3/4"	7/8"	1
ESCS3413	3/4 x 13"	3/4"	7/8"	1

Installation Instructions – All Inject-TITE Epoxies

1. Select the proper drill bit. Using only a solid carbide-tipped drill bit that meet the ANSI B212.15 standard and a hammer drill, proceed to drill the hole perpendicular to the surface and do not allow it to wobble or to ream out the hole. **Always wear safety glasses.** Follow the drill manufacturer's instructions.

2. **Cleanliness of all components is very important** to the successful use of any adhesive system. Using clean dry oil-free compressed air or a vacuum, remove the bulk of the dust and debris from the bottom of the hole.

Next — Using a brush that is at least as big as the hole in diameter (stiff nylon or wire) or a combination of multiple brushes that are together more than the hole diameter, brush the hole top to bottom and back, being very careful to clean the entire bore all the way to the bottom of the hole.

This must be done at least **3 times**. The idea is to clear the concrete of dust allowing a good flow of adhesive into the porosity of the concrete. Using clean dry oil-free compressed air (air nozzle and plastic tube for extension to the bottom of the hole would work well for this) blow out from the bottom up the dust that is brushed off of the walls of the hole. Repeated brushings will not significantly affect hole diameter.

Finally — take the brush and repeat the brushing/blowing procedure until no visible dust or debris is blown out of the hole. **Repeat no less than two more times.**

IF you do not follow these cleaning procedures, you could significantly reduce or eliminate the holding capacity of this anchoring system.

3. For 8.5 oz. and 9.3 oz. cartridges: Remove screw-top lid / cap and end plug from cartridge. Screw static mixing nozzle onto cartridge. Place assembled cartridge into the dispensing tool.

For 22 oz. and 28 oz. cartridges: Remove D-shaped plug from cartridge. Slide retaining nut over static mixer. Secure static mixer to cartridge by screwing retaining nut onto cartridge. Place assembled cartridge into the dispensing tool.

4. Make sure that adhesive is properly mixed (**uniform gray color**) when coming out of the end of the static mixing nozzle before filling any hole. This verification should be done on a piece of disposable material and not in the hole. Run a bead and check it to be sure.

5. In Concrete: Starting at the **BOTTOM** of the hole to avoid air pockets, inject Inject-TITE epoxy into the hole until it's 1/2 full while pulling static mixer out using constant uniform pressure.

In Masonry: Insert nylon or stainless steel screen into hole. Starting from the **BOTTOM** of the screen, inject Inject-TITE epoxy into the screen until it's 1/2 full while pulling static mixer out using constant uniform pressure.

NOTE: For both Concrete and Masonry: Dispense under constant uniform pressure. If dispensing is altered, re-establish uniform color prior to continuing. When using a hand dispensing tool, release pressure from tool by pressing thumb button at every pause in dispensing. Re-establish uniform color prior to continuing. Do not use epoxy with color streaks.

6. Slowly push anchor into the hole, rotating in a clockwise motion. See appropriate chart for minimum and full cure times. Anchors are to be undisturbed during the minimum cure time.

NOTE: **Always wear safety glasses.** Follow drill manufacturer's instructions. Use only solid carbide-tipped drill bits meeting ANSI B212.15 diameter standards.

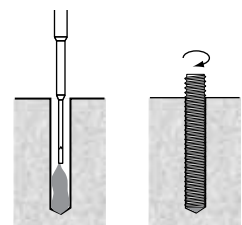
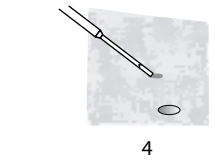
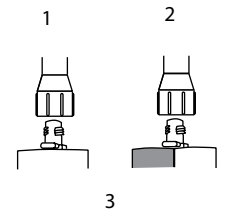
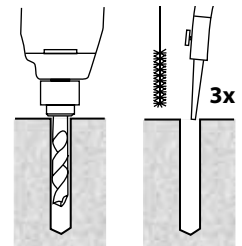

5,6
Concrete

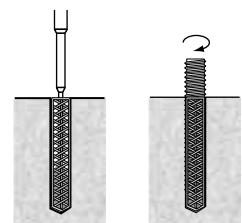

5,6
Masonry

Important Information – All Inject-TITE Epoxies

Limitations

- FOR INDUSTRIAL USE ONLY.
- Concrete or masonry surface must be frost free.
- Do not thin. Solvents will prevent proper cure.
- Minimum age of concrete must be 3 – 7 days, depending on curing and drying conditions
- NSTB safety recommendations **prohibit** the use of adhesive anchors in sustained overhead load anchoring applications.

Cautions

- Irritant to skin and eyes. Avoid skin contact.
- Use of safety goggles and chemical-resistant gloves is recommended.
- Avoid breathing vapors. Use of a NIOSH/MSHA organic vapor respirator recommended if ventilation is inadequate. Standard-Set and Fast-Set Epoxies are vapor barriers after cure.

Important Information – All Inject-TITE Epoxies

First Aid

Skin Contact

- Remove any contaminated clothing.
- Remove product immediately with a dry cloth or paper towel
- Wash skin thoroughly with soap and water. Solvents should not be used as they carry irritant into the skin.

Eye Contact

- Flush immediately with water for at least 15 minutes. Contact physician immediately.

Respiratory Problems

- Remove person to fresh air.

Cleanup

- Collect with absorbent materials. Flush area with water. Dispose of in accordance with local disposal regulations. Uncured material can be removed with Unitek CITRI-CLEAN or other approved solvent. Cured material can only be removed mechanically.

Inject-TITE™ AWF All-Weather Formula Epoxy Acrylate

Key Features/Benefits

- Allowed at close-edge distances
- Bonds to smooth diamond core drilled holes
- Working Range: -15°F to 120°F
- Sets in water-filled and damp holes
- Styrene-free
- 9.3 oz (275 ml) and 28 oz. (825 ml) cartridges available

Health	2
Flammable	3
Reactive	2



Specifications, Listings and Approvals

Shelf Life

- 12 months in original unopened container
- Storage over 80°F/27°C significantly decreases shelf life

Storage Conditions

- Store at 40–80°F/4–27°C
- Do not allow to freeze
- Store in a cool/dry location

VOC-compliant

Meets **USDA** specifications for use in food processing areas

ASTM C881, Types I, II*, IV and V* Grade 3, Classes A, B & C

State DOT: Call Customer Service

* With exception of gel time. See chart on right.

WARNING: NSTB safety recommendations **prohibit** the use of adhesive anchors in sustained overhead load anchoring applications

Order Information

Catalog No.	Description	Quantity/Box
Inject-TITE AWF All-Weather Formula		
ECA28	AWF 28 oz. (825 ml) Cartridge	8
ECA8	AWF 9.3 oz. (275 ml) Cartridge	12

See Estimating Guide on page 51.

NOTE: Mixing nozzles, dispensing tools and screens on page 47. Installation instructions on page 48.

Cure Times

Substrate Temp	Gel Time	Cure Time
-15°F (-26°C)	8 hrs.	36 hrs.†
-5°F (-21°C)	6 hrs.	28 hrs. †
0°F (-18°C)	4 hrs.	24 hrs. †
5°F (-15°C)	3 hrs.	22 hrs. †
20°F (-7°C)	45 min.	6 hrs.
40°F (4°C)	20 min.	90 min.
50°F (10°C)	15 min.	60 min.
60°F (16°C)	8 min.	45 min.
70°F (21°C)	7 min.	35 min.
80°F (27°C)	6 min.	30 min.
100°F (38°C)	5 min.	25 min.
120°F (49°C)	4 min.	20 min.

- Gel time = time limit for installation and positioning of anchor element
- † Contact Technical Support at 800-821-5846 for cold weather applications

CAUTION: AWF epoxy is flammable. Keep away from heat, sparks and flame.

Resistance of Inject-TITE AWF

To Chemicals

Key: - Non-Resistant + Resistant * Limited Resistance

Chemical	Chemical Tested	Behavior
Sulphuric Acid	Concentrate	-
	30%	*
	10%	+
Hydrochloric Acid	Concentrate	-
	10%	+
Nitric Acid	Concentrate	-
	10%	*
Phosphoric Acid	Concentrate	+
	10%	+
Acetic Acid	Concentrate	*
	10%	+
Formic Acid	Concentrate	-
	10%	*
Citric Acid	10%	+
Lactic Acid	Concentrate	+
	10%	+
Sodium Hydroxide	40%	*
Caustic Soda	20%	+
	5%	+
Ammonia	Concentrate	*
	5%	+
Soda Solution	10%	+
Common Salt Solution	10%	+
Chlorinated Lime Solution	10%	+
Sodium Hypochlorite	2%	+
Hydrogen Peroxide	10%	+
Carbolic Acid Solution	10%	-
Ethanol		-
Sea Water		+
Glycol		+
Acetone		-
Carbon Tetrachloride		-
Tolulene		*
Petrol/gasoline		*
Machine Oil		*
Diesel Oil		*

Shear and Tension Values for Reinforcing Bar†

Rebar Size (in.)	Drill Dia. (in.)	Embed. (in.)	Critical Edge Dist. (in.)	Min. Edge Dist. (in.)	Ultimate Tension 2300 psi	Ultimate Shear	
						Grade 40	Grade 60
#3	7/16	3-3/8	4-1/2	1-1/2	6220	8800	10560
#4	5/8	4-1/2	6	2	16430	16000	19200
#5	3/4	5-5/8	7-1/2	2-1/2	23310	24800	29760
#6	7/8	6-3/4	9	3	31145	35200	42240
#7	1	7-7/8	10-1/2	3-1/2	36975	48000	57600
#8	1-1/8	9	12	4	43320	62400	74880
#9	1-3/8	11-1/4	13-1/2	5	61340		

Tension Values for A-36 Threaded Rod†

Anchor Dia. (in.)	Drill Dia. (in.)	Embed. (in.)	Critical Edge Dist. (in.)	Min. Edge Dist. (in.)	Ultimate Tension		Ultimate Shear
					2,300 psi	4,300 psi	
3/8	7/16	1-11/16	4-1/2	1-1/2	3520	5330	4500
		3-3/8			10685	10785	
1/2	9/16	2-1/4	6	2	6435	9780	7720
		4-1/2			15405	19985	
5/8	3/4	2-13/16	7-1/2	2-1/2	10600	17315	12000
		5-5/8			29465	32730	
3/4	7/8	3-3/8	9	3	15780	24285	17440
		6-3/4			28995	43460	
7/8	1	3-15/16	10-1/2	3-1/2	17425	31795	23600
		7-7/8			40235	56865	
1	1-1/8	4-1/2	12	4	22980	35400	26000
		9			54715	54945	
1-1/4	1-3/8	5-5/8	13-1/2	5	33220	54230	48000
		11-1/4			74125	80180	

† For static loads, use one-fourth of the maximum tensile and shear capacities for the recommended 4:1 safety factor.

Estimating Guide: 28 oz. Cartridge

Threaded Rod in Concrete: Number of Holes per 28oz. Cartridge																				
Rod Size (in.)	Hole Size (in.)	Embedment Depth (in.)																		
		2	3	4	5	6	7	8	9	10	11	12	13	14	15	16	17	18	19	20
3/8	7/16	244	163	122	98	81	70	61	55	50	45	41	38	36	33	31	29	28	27	26
1/2	9/16	173	116	87	70	59	50	43	37	36	32	29	27	24	23	22	20	19	19	18
5/8	3/4	89	60	45	36	31	25	23	20	18	17	15	14	13	13	11	10	10	9	9
3/4	7/8	71	47	36	29	24	20	18	17	14	13	13	11	10	10	9	9	8	8	8
7/8	1	60	39	31	24	20	15	15	14	13	11	10	10	9	9	8	8	8	6	6
1	1-1/8	48	33	24	20	17	14	13	11	10	9	9	8	8	6	6	6	6	5	5
1-1/8	1-1/4	43	29	22	18	15	13	11	10	9	9	8	8	6	6	6	5	5	5	5
1-1/4	1-3/8	37	25	19	15	13	11	10	9	8	8	6	6	6	5	5	5	5	4	4
1-1/2	1-5/8	29	20	15	13	10	9	8	6	6	6	5	5	5	4	4	4	4	4	4

Rebar in Concrete: Number of Holes per 28oz. Cartridge																				
Rebar Size	Hole Size (in.)	Embedment Depth (in.)																		
		2	3	4	5	6	7	8	9	10	11	12	13	14	15	16	17	18	19	20
No. 3	1/2	207	139	104	84	70	60	52	47	42	38	36	33	31	28	27	25	24	23	22
No. 4	5/8	162	108	81	65	55	47	41	37	33	31	28	25	24	22	20	19	19	18	18
No. 5	3/4	131	88	66	52	45	38	33	29	27	24	22	20	19	18	17	15	15	14	14
No. 6	7/8	104	70	52	41	36	31	27	24	22	19	18	17	15	14	14	13	13	11	11
No. 7	1	92	61	46	37	31	27	23	20	19	17	15	14	14	13	11	11	10	10	10
No. 8	1-1/8	79	52	39	32	27	23	20	18	17	15	14	13	11	11	10	10	9	9	9
No. 9	1-3/8	39	27	20	17	14	11	10	9	9	8	8	6	6	5	5	5	5	5	4
No. 10	1-1/2	38	25	19	15	13	11	10	9	8	8	6	6	6	5	5	5	5	5	4

Estimating Guide: 9.3 oz. Cartridge*

All Thread in Concrete: Number Holes Per 9.3 oz Cartridge*																				
Size (in.)	Hole Size (in.)	Embedment Depth (inches)																		
		2	3	4	5	6	7	8	9	10	11	12	13	14	15	16	17	18	19	20
3/8	7/16	81	54	41	33	28	23	21	19	17	15	13	13	12	11	10	10	10	9	9
1/2	9/16	58	39	29	23	20	17	14	12	12	11	10	9	8	8	8	7	7	7	6
5/8	3/4	30	20	15	12	10	9	8	7	6	6	6	4	4	4	3	3	3	3	3
3/4	7/8	24	15	12	10	8	7	6	6	4	4	4	3	3	3	3	3	3	2	2
7/8	1	20	13	10	8	7	6	6	4	4	3	3	3	3	3	2	2	2	2	2
1	1-1/8	17	11	8	7	6	4	4	3	3	3	3	2	2	2	2	2	2	2	2
1-1/8	1-1/4	14	10	8	6	6	4	3	3	3	3	2	2	2	2	2	2	2	2	2
1-1/4	1-1/2	12	9	7	6	4	3	3	3	2	2	2	2	2	2	2	2	2	1	1
1-1/2	1-5/8	10	7	6	4	3	3	2	2	2	2	2	2	2	1	1	1	1	1	1

Rebar in Concrete: Number Holes Per 9.3 oz Cartridge*																				
Rebar Size	Hole Size (in.)	Embedment Depth (inches)																		
		2	3	4	5	6	7	8	9	10	11	12	13	14	15	16	17	18	19	20
No. 3	1/2	69	46	35	29	23	20	18	15	14	13	12	11	10	10	9	9	8	8	8
No. 4	5/8	54	36	28	22	19	15	13	12	11	10	10	9	8	8	7	7	7	6	6
No. 5	3/4	44	30	22	18	15	13	11	10	9	8	8	7	7	6	6	6	6	4	4
No. 6	7/8	35	23	18	13	12	10	9	8	8	7	6	6	6	4	4	4	4	3	3
No. 7	1	31	21	15	12	10	9	8	7	7	6	6	4	4	4	3	3	3	3	3
No. 8	1-1/8	26	18	13	11	9	8	7	6	6	6	4	4	3	3	3	3	3	3	3
No. 9	1-3/8	13	9	7	6	4	3	3	3	3	2	2	2	2	2	2	2	2	2	1
No. 10	1-1/2	13	9	7	6	4	3	3	3	2	2	2	2	2	2	2	2	2	2	1

Dowel in Concrete: Number Holes Per 9.3 oz Cartridge*																				
Dowel Size (in.)	Hole Size (in.)	Embedment Depth (inches)																		
		2	3	4	5	6	7	8	9	10	11	12	13	14	15	16	17	18	19	20
3/4	7/8	35	24	18	14	12	10	9	8	8	7	6	6	6	4	4	4	4	3	3
7/8	1	31	21	15	12	10	9	8	7	7	6	6	4	4	4	3	3	3	3	3
1	1-1/8	26	18	13	11	9	8	7	6	6	4	4	4	3	3	3	3	3	3	2
1-1/4	1-3/8	21	14	11	9	8	6	6	4	4	3	3	3	3	3	3	2	2	2	2
1-1/2	1-5/8	18	12	9	8	6	6	4	4	3	3	3	3	2	2	2	2	2	2	2

* The number of anchoring installations is based upon calculations of hole volumes using ANSI tolerance carbide tipped drill bits, the nominal areas of the reinforcing bars and the stress areas of the threaded rods. These estimates do not account for waste.

Key Features/Benefits

- Won't shrink, avoiding unwanted forces in member
- For both solid and hollow base materials
- Non-sag
- Low odor
- Solvent-free, allowing for greater flexibility in applications
- Eliminates expansion forces
 - Allows use close to a free edge
- **Not sensitive to UV light after cure**
- Moisture insensitive before, during and after cure
 - Allows use in wet or damp holes
- Resists tensile and shear loads due to earthquake and wind
 - Allows use in areas with seismic concerns
- Weather-resistant
 - Can be used in locations subject to severe exterior weather conditions
- 8.5 oz (250 ml) and 22 oz. (600 ml) containers available



Health	3
Flammable	1
Reactive	2



Specifications, Listings and Approvals

Shelf Life

- Two-year shelf life in original, unopened container

Storage Conditions

- Store at 40° - 95° F, do not allow to freeze
- Precondition cartridges to over 73° F
- For cold weather (below 70° F), precondition cartridges slowly to 80-90° F for easier dispensing

ASTM C881 , Types I and IV, Grade 3, Classes A, B and C

VOC-compliant

NSF/ANSI 61 certified

Meets **USDA** specifications for use in food processing areas

Code Compliance:

- **ICC-ES Report Number ESR-2621** for Uncracked Concrete (Additional Listee) per AC08
- 2009, 2006 and 2003 International Building Code (IBC)
- 2009, 2006 and 2003 International Residential Code (IRC)
- 1997 Uniform Building Code (UBC)
- 2007 Florida Building Code (Building)
- 2007 Florida Building Code (Residential)
- Miami-Dade County Approval

State DOT: Call Customer Service

Order Information

Catalog No.	Description	Quantity
Inject-TITE Adhesive Anchors: Two-component Cartridges		
ECT8F	8.5 oz. Fast Set Epoxy	1
ECT22F	22 oz. Fast Set Epoxy	1

NOTE: Fits standard 10" dispensing tool. Use double-cartridge dispensing tool for 22 oz. cartridges. NOTE: Mixing nozzles, dispensing tools and screens on page 47. Installation instructions on page 48.

Estimating Guide

Solid Concrete: Number of Holes per Cartridge											
Bolt Size	3/8"		1/2"		5/8"		3/4"		7/8"		
Hole Size	7/16"		9/16"		3/4"		7/8"		1"		
Cartridge Size	8.5oz.	22oz.	8.5oz.	22oz.	8.5oz.	22oz.	8.5oz.	22oz.	8.5oz.	22oz.	
	Embedment	3"	49	128	35	91	14	47	14	37	12
4"		37	96	26	68	11	35	11	28	9	24
5"		30	77	21	55	9	28	9	23	7	19
6"		25	64	18	46	7	24	7	19	6	16
7"		21	5	15	39	6	20	6	16	5	12
8"		19	48	13	34	5	18	5	14	5	12
9"		17	43	11	29	5	16	5	13	4	11

Allowable Spacing & Edge Distance

	Distance for Full Anchor Capacity (Critical Distance)	Distance for Reduced Anchor Capacity (Minimum Distance)	Reduction Factor
Spacing Between Anchors	24D	8D	.90
Edge Distance – Tension Loads	12D	See below	See below
Edge Distance – Shear Loads Threaded Rod	12D	4D	.21
Edge Distance – Shear Loads Rebar	16D	4D	.15

WARNING: NSTB safety recommendations **prohibit** the use of adhesive anchors in sustained overhead load anchoring applications

NOTE: Do not allowed mixed epoxy to reside in static mixing head or mixer for more than 5 minutes, or gelation and blockage may result.

Minimum Cure Times

Minimum Substrate Temp.	Fast-Set Cure Time	Fast-Set Minimum Cure Time
40°F (5°C)	48 hrs	24 hrs
65°F (18°C)	36 hrs	8 hrs
70°F (21°C)	24 hrs	2.5 hrs
80°F (27°C)	12 hrs	2 hrs
100°F (38°C)	6 hrs	1 hrs

- Cure Time is time required before epoxy reaches ultimate strength. Minimum Cure Time is minimum time required before the design or allowable load may be applied.
- Anchors are to be undisturbed during the minimum cure time.
- GEL TIME: (60 g. mass); 35 min. at 73°F ± 2° (23°C) for Standard Set; 8 min. at 73°F ± 2° (23°C) for Fast Set.
- Use dry aggregate only.

Ultimate Loads For Threaded Rod Installed In Hollow Block Using Inject-TITE™ Fast-Set Formula

Threaded Rod Dia. (in.)	Drill Bit Dia. (in.)	Embed. Depth (in.)	Tension Load (lb.)	Shear Load (lb.)
3/8	1/2	3-1/2	1500	3000
1/2	5/8	4	2500	4000
5/8	3/4	4-1/2	3000	5000
3/4	7/8	6	4000	6000

Ultimate Loads For Threaded Rod Installed In Grout-Filled Block Using Inject-TITE™ Fast-Set Formula

Threaded Rod Dia. (in.)	Drill Bit Dia. (in.)	Embed. Depth (in.)	Tension Load (lb.)	Shear Load (lb.)
3/8	7/16	3-1/2	6900	4500
1/2	9/16	4-1/2	8600	6500
5/8	3/4	5	11000	9500
3/4	7/8	6-1/2	15000	11500

Average Ultimate Load (lb.) For Reinforcing Bar Installed In Normal Weight Concrete

Rebar Size (in.)	Drill Bit Dia. (in.)	Embed. (in.)	Tension Ultimate Bond Strength Concrete Strength		
			2500 psi	4000 psi	5500 psi
4	1/2	3-3/8	7080	9050	11020
5	5/8	4-1/2	12300	14730	17160
6	3/4	5-5/8	16000	18810	21620
8	1	6-3/4	39035	.	.
9	1-1/8	7-7/8	36740	.	.
10	1-1/4	9	42670	.	.

For static loads, use one-fourth of the maximum tensile and shear capacities for the recommended 4:1 safety factor

Minimum Edge Distance Requirements For Tension Loads For Anchors Installed In Concrete

Stud Size (in.)	Minimum Edge Distance (in)	Reduction Factor
3/8	1-1/2	.70
1/2	1-3/4	.66
5/8	1-3/4	.70
3/4	1-3/4	.70
7/8	3-1/2	.70
1	4	.70
1-1/4	5	.70

Ultimate Load (Lb.) For Threaded Rod Installed In Stone Aggregate Concrete and Static Loading Conditions

Stud Dia. (in.)	Drill Bit Dia. (in.)	Embedment (in.)	Ultimate Bond Strength Concrete Strength			A 36 Rod Ultimate Shear
			2500 psi	4000 psi	5500 psi	
3/8	7/16	3-3/8	7300	8250	9200	4500
	9/16	3-3/8	9560	.	.	.
	7/16	5-5/8	10980	11360	11740	4500
1/2	9/16	4-1/2	10540	11730	12920	7720
	11/16	4-1/2	14640	.	.	.
	9/16	7-1/2	14660	17010	19360	7720
5/8	3/4	5-5/8	14800	18870	22940	12000
	7/8	5-5/8	23340	.	.	.
	3/4	9-3/8	21560	26260	30960	12000
3/4	7/8	6-3/4	22380	25870	29360	17440
	1	6-3/4	29850	34340	38360	.
	7/8	11-1/4	30320	34340	38360	17440
7/8	1	7-7/8	43280	.	.	23600
1	1-1/8	9	55650	.	.	26000
1-1/4	1-3/8	11-1/4	77860	.	.	48000

Resistance of Inject-TITE Fast-Set To Chemicals

Chemical	Chemical Tested	Resistant	Not Resistant
Alkalize	Concrete Drilling Mud (10%) pH=12.6	*	
Base Material	Concrete Drilling Mud(10%) pH=13.2	*	
Concrete	Concrete Potash Solution (10%) pH=14.0	*	
Acid†	Acetic Acid (10%)		*
	Nitric Acid (10%)		*
	Hydrochloric Acid (10%) 3mo.		*
	Sulfuric Acid (10%)		*
Solvents	Benzyl Alcohol		*
	Ethanol		*
	Ethyl Acetate		*
	Methyl Ethyl Ketone (MEK)		*
	Trichlorethylene		*
	Xylene (mixture)	*	
	Chemicals Used on Jobsites	Concrete Plasticizer	*
	Diesel Oil	*	
	Oil	*	
	Petrol/gasoline	*	
	Forming Oil (oil for form work)	*	
Environmental Chemicals	Salt Water	*	
	De-mineralized water	*	
	Salt spray tests	*	
	SO ₂	*	
	Environment/Weather	*	

† Concrete was dissolved by acid.

Key Features/Benefits

- Won't shrink, avoiding unwanted forces in member
- For both solid and hollow base materials
- Non-sag
- Low odor
- Eliminates expansion forces
 - Allows use close to free edge
- Solvent-free, allowing for greater flexibility in applications
- Two-year shelf life in original, unopened container
- Not sensitive to UV light after cure
- Moisture insensitive before, during and after cure
 - Allows use in wet or damp holes
- Resists tensile and shear loads due to earthquake and wind
 - Suitable for seismic conditions
- 22 oz. (600 ml) size available only



Health	3
Flammable	1
Reactive	2



Specifications, Listings and Approvals

ASTM C881 , Types I, II, IV and V, Grade 3, Classes B and C

Miami-Dade County NOA: 00-0229.05

NSF/ANSI 61 certified

VOC-compliant

Meets **USDA** specifications for use in food processing areas

State DOT: Call Customer Service

WARNING: NSTB safety recommendations **prohibit** the use of adhesive anchors in sustained overhead load anchoring applications

Order Information

Catalog No.	Description	Quantity
ECT22	Standard-Set Epoxy 22 oz. Two-Component Cartridge	1

NOTE: Fits standard 10" dispensing tool. Use double-cartridge dispensing tool for 22 oz. cartridges. Mixing nozzles, dispensing tools and screens on page 47. Installation instructions on page 48.

Allowable Spacing & Edge Distance

	Distance for Full Anchor Capacity (Critical Distance)	Distance for Reduced Anchor Capacity (Min. Distance)	Reduction Factor
Spacing Between Anchors	24D	8D	.90
Edge Distance: Tension Loads	12D	See Below	See Below
Edge Distance: Shear Loads Threaded Rod	12D	4D	.21
Edge Distance: Shear Loads Rebar	16D	4D	.15

Minimum Edge Distance Requirements For Tension Loads For Anchors Installed In Concrete

Stud Size (in.)	Minimum Edge Distance C	Reduction Factor
3/8	1-1/2	.70
1/2	1-3/4	.66
5/8	1-3/4	.70
3/4	1-3/4	.70
7/8	3-1/2	.70
1	4	.70
1-1/4	5	.70

NOTES:

1. The listed values are the minimum distances required to obtain the load values in the tables above. D = anchor diameter. When adjacent anchors are different sizes or embedments, use the largest value for D.
2. The listed values are the minimum distances at which the anchor can be installed when load values are adjusted in accordance with reduction factor.
3. Load values in the table are multiplied by the reduction factor when anchors are installed at the minimum spacing listed. Use linear interpolation for spacing between critical and minimum distances. Multiple reduction factors for more than one spacing or edge distance are calculated separately and multiplied.

Estimating Guide

Solid Concrete: Number of Holes per 22 oz. Cartridge						
Bolt Size (in.)	3/8	1/2	5/8	3/4	7/8	
Hole Size (in.)	7/16	9/16	3/4	7/8	1	
Embedment Depth (in.)	3	128	91	47	37	31
	4	96	68	35	28	24
	5	77	55	28	23	19
	6	64	46	24	19	16
	7	55	39	20	16	12
	8	48	34	18	14	12
	9	43	29	16	13	11

Cure Times

Minimum Substrate Temp.	Standard-Set Cure Time
65°F (18°C)	48 hrs.
70°F (21°C)	36 hrs.
80°F (27°C)	24 hrs.
100°F (38°C)	12 hrs.

NOTES:

1. Cure Time is time required before epoxy reaches ultimate strength.
2. GEL TIME: (60 g. mass); 35 min. at 73°F ± 2° (23°C) for Standard Set.
3. Do NOT allow to freeze.
4. Use dried aggregate only.

NOTE: Do not allowed mixed epoxy to reside in static mixing head or mixer for more than 5 minutes, or gelation and blockage may result.

Average Ultimate Load (lb.) for A-36 Threaded Rod Installed In Stone Aggregate Concrete Static Loading Conditions

Stud Dia. (in.)	Hole Dia. (in.)	Embed. (in.)	Ultimate Bond Strength Concrete Strength			Ultimate Shear 4000 psi
			2500 psi	4000 psi	5500 psi	
3/8	7/16	3-3/8	7300	8250	9200	4500
	9/16	3-3/8	9560	•	•	•
	7/16	5-5/8	10980	11360	11740	4500
1/2	9/16	4-1/2	10540	11730	12920	7720
	11/16	4-1/2	14640	•	•	•
	9/16	7-1/2	14660	17010	19360	7720
5/8	3/4	5-5/8	14800	18870	22940	12000
	7/8	5-5/8	23340	•	•	•
	3/4	9-3/8	21560	26260	30960	12000
3/4	7/8	6-3/4	22380	25870	29360	17440
	1	6-3/4	29850	34340	38360	•
	7/8	11-1/4	30320	34340	38360	17440
7/8	1	7-7/8	43280	•	•	23000
1	1-1/8	9	55650	•	•	26000
1-1/4	1-3/8	11-1/4	77860	•	•	48000

Average Ultimate Load (lb.) for Reinforcing Bar Installed In Normal Weight Concrete*

Rebar Size (in.)	Drill Dia. (in.)	Embed. (in.)	Tension Ultimate Bond Strength Concrete Strength		
			2500 psi	4000 psi	5500 psi
4	1/2	3-3/8	7080	9050	11020
5	5/8	4-1/2	12300	14730	17160
6	3/4	5-5/8	16000	18810	21620
8	1	6-3/4	39035	•	•
9	1-1/8	7-7/8	36740	•	•
10	1-1/4	9	42670	•	•

*For static loads, use one-fourth of the maximum tensile and shear capacities for the recommended 4:1 safety factor.

Slam-TITE™ Hammer-In Chemical Capsules

Key Features/Benefits

- Easy to install
 - Just use a hammer to drive in
 - 3/8" through 3/4" capsules can be set either end up
 - Larger capsules – rounded side down
- Economical
 - Minimal waste - use only the amount you require
 - No disposal of excess material necessary
- Works in all types of weather
- Eliminates expansion forces
 - Allows use close to a free edge
- Innovative package design means less breakage

Health	2
Flammable	1
Reactive	0

WARNING: NSTB safety recommendations **prohibit** the use of adhesive anchors in sustained overhead load anchoring applications



Specifications, Listings and Approvals

State DOT Approvals: Call Customer Service

Order Information

Catalog Number	Nominal Dia. (in.)	Slam-TITE Capsule Dimensions (in.)	With Studs		With Rebar		Capsule Volume (cubic in.)	Embedment Depth (in.)	Quantity Capsules/Box
			Stud Size (in.)	Drill Dia. (in.)	Rebar Dim.	Drill Dia. (in.)			
HMC10-38	3/8	3/8 x 3-3/8	3/8	7/16	#3	1/2	0.3	3-1/2	10
HMC12-12	1/2	1/2 x 3-3/8	1/2	9/16	#4	5/8	0.6	4-1/4	10
HMC16-58	5/8	5/8 x 3-3/4	5/8	3/4	#5	3/4	1.1	5-1/2	10
HMC20-34	3/4	3/4 x 4-3/4	3/4	7/8	#6	1	2.0	5-3/4	10
HMC22-78	7/8	7/8 x 7	7/8	1	#7	1-1/8	2.9	7	6
HMC24-1	1	1 x 8-1/2	1	1-1/8	#8	1-1/4	4.2	8-1/4	6
HMC30-114	1-1/4	1-1/4 x 10-1/2	1-1/4	1-3/8	•	•	11.6	11	2

Can be used with straight-edge stud assemblies. See page 47.

Maximum Tensile Capacities

Threaded Rod					
Catalog Number	Threaded Rod Dia. (in.)	Drill Dia. (in.)	Embedment (in.)	Tensile Value in 4000 psi Concrete (lb.)	Shear Value in 4000 psi Concrete (lb.)
HMC10-38	3/8	7/16	3-1/2	5395	4500
HMC12-12	1/2	9/16	4-1/4	8318	7720
HMC16-58	5/8	3/4	5-1/2	15287	12000
HMC20-34	3/4	7/8	5-3/4	17985	17440
HMC22-78	7/8	1	7	22481	23600
HMC24-1	1	1-1/8	8-1/4	32372	26000
HMC30-114	1-1/4	1-3/8	11	•	44762

Reinforced Bar				
Catalog Number	Rebar Size	Drill Dia. (in.)	Embedment (in.)	Tensile Value in 4000 psi Concrete (lb.)
HMC10-38	#3	1/2	3-1/2	6295
HMC12-12	#4	5/8	4-1/4	9217
HMC16-58	#5	3/4	5-1/2	15287
HMC20-34	#6	1	5-3/4	17985
HMC22-78	#7	1-1/8	7	22481
HMC24-1	#8	1-1/4	8-1/4	32372

NOTES:

- Information provided only for use of a qualified design engineer. Use of technical data by persons not qualified could cause serious damage, injury, or even death.
- Ultimate values shown. For static loads, use one-third of the maximum tensile and shear capacities for the recommended 3:1 safety factor.
- Tensile strength data verified by FMFA at the University of Stuttgart. Available upon request.
- Shear: A-36 rod.

CAUTION: For ultimate anchorage capacity, use lowest value of bond strength, steel strength or concrete capacity.

Installation Instructions

1. All surfaces should be clean and free of grease, oil, and moisture. Base materials must be at least 23° F.
2. Select the proper size drill bit. Drill the hole perpendicular to the work surface: To assure full holding power, do not ream the hole, or allow the hammer drill to wobble. See chart or package for proper hole depth and embedment for each specific anchor, but not closer than two anchor diameters to the bottom (opposite) surface of the concrete.
3. Clean the hole using dry, oil-free compressed air and a clean wire brush. Dust and debris left in hole will significantly reduce the holding capacity of the anchor.
4. Insert straight-cut stud into hole. Mark stud to indicate hole depth. Remove stud and check for dust accumulation. If dust is found, go back to step 3. (Straight-cut stud properly mixes the components – avoid using beveled-cut studs with Slam-TITE capsules.)
5. Check the capsule (must NOT be damaged). The 3/8", 1/2", 5/8" and 3/4" capsules may be set either end down. Set larger capsules rounded end down.
6. Tap stud with hammer until capsule breaks, and then drive stud in with hammer until stud is embedded to mark, indicating desired embedment depth.

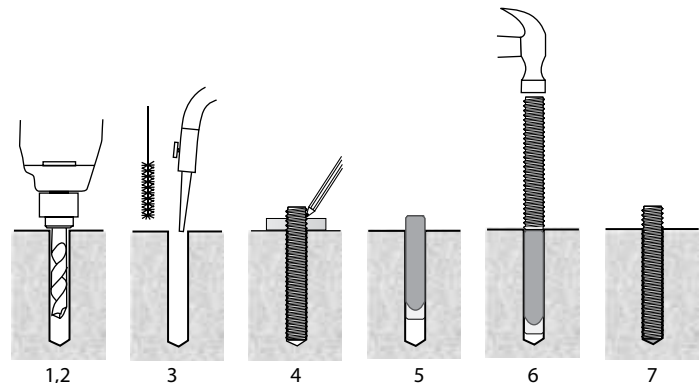

7. Avoid disturbing stud. Allow resin to cure for the specified time before loading stud.

NOTE: Always wear safety glasses. Follow the drill manufacturer's safety instructions. Use only solid carbide-tipped drill bits meeting ANSI B212.15 diameter standards. Fumes and contact with skin may be harmful.

Storage Requirements

For maximum shelf life, Slam-TITE Hammer-In Capsules should be stored in the original packaging, in a temperature-controlled environment (23-75 °F). The 3/4", 7/8", 1" and 1-1/4" must be standing up with white end down. Shelf life of up to 2 years is possible, for 3/8", 1/2" and 5/8" diameter; 1 year on 3/4", 7/8", 1" and 1-1/4", but higher than recommended storage temperatures and exposure to UV rays may adversely affect the resin and significantly reduce shelf life. The capsules must be physically undamaged and properly stored, or the pull-out values may decrease below the safety limit. Some crystallization is normal on 3/4" to 1-1/4".

Minimum Cure Times

Temperature	Minimum Cure Time
68°F and over	45 minutes
59°F to 68°F	90 minutes
50°F to 59°F	3 hours
41°F to 50°F	4 hours
32°F to 41°F	14 hours
23°F to 32°F	24 hours

Edge Distance and Spacing Requirements

Embedment (E) in Anchor Diameters	Spacing	Edge Distance
$E < 6d$ (shallow)	3.5E	1.75E
$6d \leq E \leq 8d$ (standard)	2.00E	1.00E
$8d < E$ (deep)	1.50E	0.75E



Key Features/Benefits

- For use in reinforced and unreinforced, non-cracked concrete (3625 psi – 8700 psi)
- Eliminates expansion forces
 - Can be used close to an edge
- “Synthetic mortar” bonds stud assembly to concrete and lightweight and soft masonry substrates
- Minimizes loosening from vibration and shock
- Innovative package design prevents accidental breakage
- Economical – no waste, because it is pre-measured

Health	2
Flammable	1
Reactive	0

Specifications, Listings and Approvals

For use in reinforced and unreinforced, non-cracked concrete (3625 psi – 8700 psi)

State DOT Approvals: Call Customer Service

WARNING: NSTB safety recommendations **prohibit** the use of adhesive anchors in sustained overhead load anchoring applications

Minimum Cure Times

Temperature	Minimum Cure Time
68°F and over	45 minutes
59°F to 68°F	90 minutes
50°F to 59°F	2 hours
41°F to 50°F	2.5 hours
32°F to 41°F	4 hours
23°F to 32°F	8 hours

Order Information

Catalog No.	Nom. Dia. (in.)	Capsule Dims. (in.)	Capsule Volume (cubic in.)	Drill Dia. (in.)	Embed. Depth (in.)	Quantity Capsules / Box	Appropriate Stud Size (in.)
M10-38	3/8	3/8 x 3-3/8	0.3	7/16	3-1/2	10	3/8
M12-12	1/2	1/2 x 3-3/4	0.6	9/16	4-1/4	10	1/2
M16-58	5/8	5/8 x 3-3/4	1.1	3/4	5	10	5/8
M20-34	3/4	3/4 x 4-3/4	2.0	7/8	6-5/8	10	3/4
M22-78	7/8	7/8 x 7	2.9	1	7	6	7/8
M24-1	1	1 x 8-1/4	4.2	1-1/8	8-1/4	6	1
M30-114	1-1/4	1-1/4 x 10-5/8	11.6	1-3/8	11	2	1-1/4

Bevel Cut Stud Assemblies: For Spin-In Capsules ONLY



Carbon Steel ASTM A36	Stainless Steel		Dimensions (in.)	Quantity (in.)
	304	316		
CS238	CSS38	CS638	3/8 x 5	50/300
CS212	CSS12	CS612	1/2 x 6-1/4	25/150
CS258	CSS58	CS658	5/8 x 7-1/2	10/60
CS234	CSS34	CS634	3/4 x 9-1/2	10/40
CS278	CSS78	CS678	7/8 x 10-1/4	10/40
CS210	CSS10	•	1 x 11-3/4	5/20
CS2114	•	•	1-1/4 x 14	5/20

Edge Distance and Spacing Requirements

Embedment (E) in Anchor Diameters (d)	Spacing	Edge Distance
E < 6d (shallow)	2.00E	1.00E
6d ≤ E ≤ 8d (standard)	1.50E	1.00E
8d < E (deep)	1.00E	0.75E

Installation Instructions

1. All surfaces should be clean and free of grease, oil, and moisture. Base materials must be at least 23° Fahrenheit.
2. Select the proper size drill bit from chart below. Drill the hole perpendicular to the work surface: To assure full holding power, do not ream the hole, or allow the hammer drill to wobble. See chart or package for proper hole depth embedment for each specific anchor, but not closer than two anchor diameters to the bottom (opposite) surface of the concrete.
3. Clean the hole using dry, oil-free compressed air and a clean wire brush. Dust and debris left in hole will significantly reduce the holding capacity of the anchor.
4. Insert 45° chamfered stud into hole. Mark stud to indicate hole depth. Remove stud and check for dust accumulation. If dust is found on stud, go back to step 3. Beveled cut stud is needed for proper mixing of components; avoid straight cut studs with Spin-In anchors.
5. Check the capsule (must NOT be damaged). Install capsules rounded end down.
6. Connect the stud assembly on a hammer drill. Break capsule with the 45° chamfered end of stud. Using the hammer drill, drive stud to bottom of hole as indicated by mark on stud. Turn off immediately. **DO NOT continue to spin stud after it has reached its intended embedment!** Release stud and remove the hammer drill.
7. Avoid disturbing the stud. Allow resin to cure for specified time before loading stud.

NOTE: Always wear safety glasses. Follow the drill manufacturer's safety instructions. Use only solid carbide-tipped drill bits meeting ANSI B212.15 diameter standards.
† Fumes and contact with skin may be harmful.

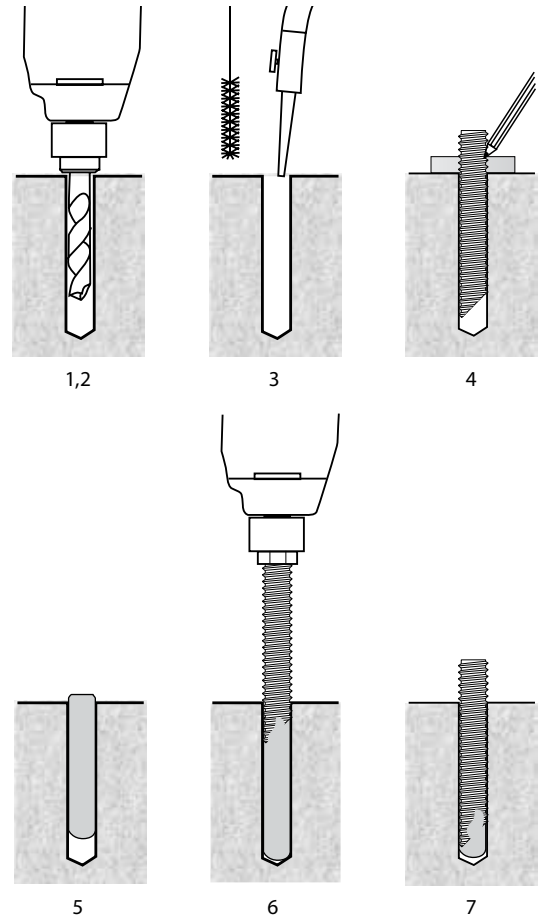

Maximum Tensile Capacity

Catalog Number	Embedment Depth (in.)	Drill Dia. (in.)	Tension Values 4000 psi (lb.)	Shear Values 4000 psi (lb.)
M10-38	3-1/2	7/16	4721	4500
M12-12	4-1/4	9/16	6744	7720
M16-58	5	3/4	10116	12000
M20-34	6-5/8	7/8	18210	17440
M22-78	7	1	22481	23600
M24-1	8-1/4	1-1/8	24954	26000
M30-114	11	1-3/8	40466	48000

NOTES:

- Information provided only for use of a qualified design engineer. Use of technical data by persons not qualified could cause serious damage, injury, or even death.
- Ultimate values shown. For static bonds, use one-third of the maximum tensile and shear capacities for the recommended 3:1 safety factor.
- Shear: A-36 rod.

CAUTION: For ultimate anchorage capacity, use lowest value of bond strength, steel strength or concrete capacity.

Storage Requirements

For maximum shelf life, Wej-It® Chemical Capsules should be stored in the original packaging, in a temperature-controlled environment (23-75° F) that is well-ventilated and dry. Shelf life of up to 2 years is possible, but higher-than-recommended storage temperatures and exposure to UV rays may adversely affect the resin and significantly reduce shelf life. The capsules must be physically undamaged and properly stored, or the pull-out values may decrease below the safety limit.

PRODUCT WARRANTY STATEMENT:

Mechanical Plastics Corp., in its sole discretion and option, will repair, replace or refund the original purchase price of the product for a period of 6 months from the date of sale by Mechanical Plastics Corp. or its distributors provided that the product contains a defect in material or workmanship, excluding normal wear and tear.

This warranty statement does not apply to any products not installed or used in compliance with the published instructions, proper and specific installment procedures, modifications to the product, defective materials to which the product is attached or which have deteriorated, use in conjunction with other manufacturers' anchors, acts of war, acts of terrorism, Force Majeure or any other extraordinary events.

NOTIFICATION:

Absence the receipt of notification by Mechanical Plastics Corp. of any such defect within the 6 months period shall constitute a waiver of any and all claims with regard to such product and sale.

LIMITATION OF LIABILITY:

To the extent permitted by law, the foregoing warranty is expressly in lieu of any and all other warranties, whether express or implied, including but not limited to the implied warranty of fitness for a particular purchase and the implied warranty of merchantability, and whether by statute, case law or otherwise. This warranty is the sole warranty provided by Mechanical Plastics Corp. No warranty is given in respect to the modification or improper installation of any product.

LIMITATION OF DAMAGES:

In no event shall Mechanical Plastics Corp. (including but not limited to its agents, directors, employees, managers, members, officers, representatives or shareholders) be liable to any entity, individual, organization or person for any lost income, lost opportunities, lost profits, lost savings, capital costs, or for any direct or indirect damages, or for any special or punitive damages, or for any consequential or incidental damages including but not limited to costs and attorney fees arising out of or related to the sale, use or inability to use the product whether based on contract, tort, warranty or other equitable or legal grounds.

INDEMNIFICATION:

Purchaser and/or customer hereby agrees to defend, indemnify and hold harmless Mechanical Plastics Corp. for any and all claims by any entity, person or third party for any damages, losses, special losses, punitive claims, or other claims and any consequential costs, including but not limited to legal costs and attorneys' fees.

ACCEPTANCE OF TERMS:

Purchase of any product from Mechanical Plastics Corp. is evidence of acceptance of these warranty terms by the purchaser.

Wej-It®, Ankr-TITE®, Bolt Size is Hole Size®, POWER-Drop™, POWER-Sert™, POWER Screw Bolt™, Inject-TITE™, Slam-TITE™, and FRICTION-FIT™ are trademarks of Wej-It Fastening Systems, a Division of Mechanical Plastics Corp. TOGGLER®, SNAPTOGGLE®, ALLIGATOR®, SnapSkru®, HIGH-PERFORMANCE ANCHORS®, SP®, TA®, TB®, TC®, TH®, TOGGLER logo figure, and ALLIGATOR logo figure are worldwide registered trademarks of Mechanical Plastics Corp.

UltraCon®, Stalgard® and Elco® are registered trademarks of Infatech Intellectual Properties Pte. Ltd.

Tapcon® is a registered trademarks of Illinois Tool Works Inc.

ClosetMaid® is a registered trademark of the ClosetMaid Corporation, a subsidiary of Emerson Electric Co.

SDS-max® and SDS-plus® are registered trademarks of Robert Bosch GmbH.

TOGGLER[®]
HIGH-PERFORMANCE ANCHORS[®]

wej-it[®]
FASTENING SYSTEMS

Divisions of Mechanical Plastics Corp.
110 Richards Avenue • Norwalk, CT 06854

Call us toll-free: 888-TOGGLER (888-864-4537)
Fax: 203-857-2201 • E-mail: info@toggler.com
www.toggler.com • www.wejit.com



The new 105,000 sq. ft. home of TOGGLER[®] and Wej-It[®] in Norwalk, Connecticut. Renovation in progress.