

**TAMPERPROOF**  
SCREW CO., INC. OF NEW YORK

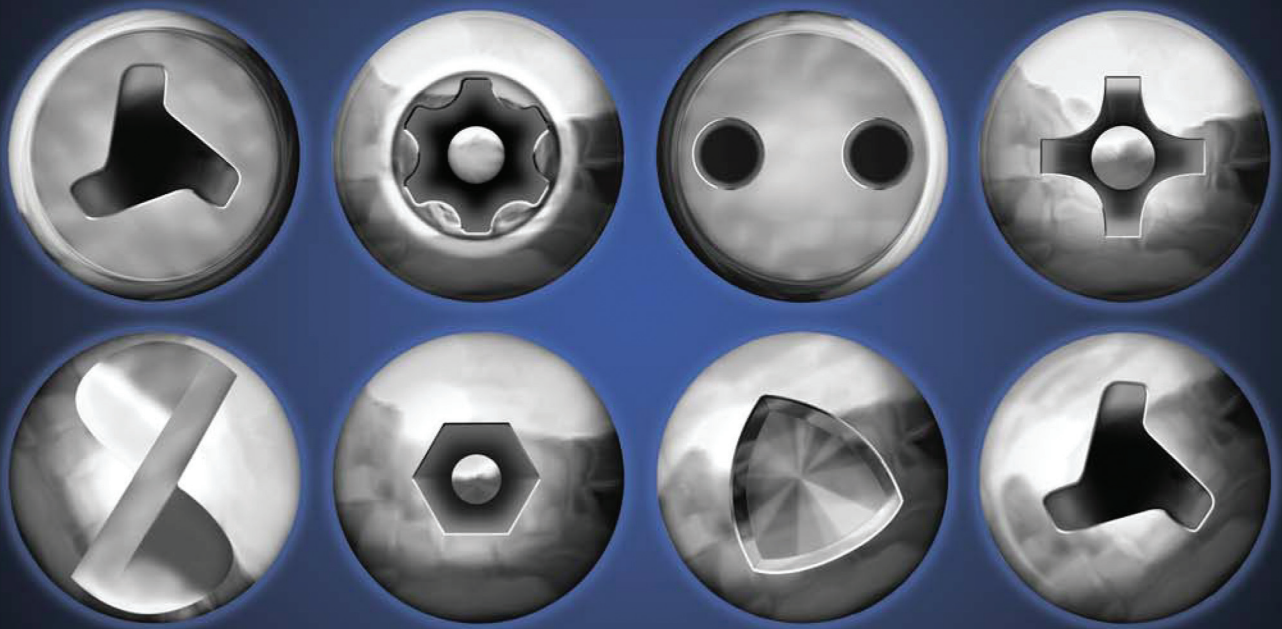

SECURITY SCREWS AND TOOLS

# CONTENTS

## SNAKE EYES® SPANNERS

### MACHINE SCREWS

Pan Head.....	6
Truss Head .....	7
Flat Head .....	7
Flat Head (Brass) .....	9
Oval Head .....	9
Oval Head (Brass).....	10

### SHEET METAL SCREWS

Truss Head .....	10
Pan Head.....	11
Flat Head .....	11
Oval Head .....	12

## NUTS

Spanner Nuts & Tools .....	13
Breakaway Nuts .....	13

## SOCKET SECURITY

### CAP SCREWS

Button Head.....	14
Flat Head .....	15

### SHEET METAL SCREWS

Button Head.....	15
------------------	----

## TORX® SECURITY

### MACHINE SCREWS

Button Head.....	16
Flat Head .....	17

### SHEET METAL & SELF-DRILLING SCREWS

Button Head.....	16
Pan Head (Self-Drilling).....	17
Flat Head .....	17

## PHILLIPS SECURITY

### MACHINE SCREWS

Pan Head.....	18
Flat Head .....	19

### SHEET METAL SCREWS

Pan Head.....	20
Flat Head .....	21

## ONE-WAY

### MACHINE SCREWS

Round Head .....	22
Truss Head .....	22
Oval Head .....	23
Sex Bolts .....	24

## ONE-WAY

### SHEET METAL SCREWS

Round Head .....	23
Oval Head .....	24

## TRI-WING®

### SHEET METAL SCREWS

Pan Head.....	25
---------------	----

### MACHINE SCREWS

Pan Head.....	25
---------------	----

## OPSIT®

### SHEET METAL SCREWS

Truss Head .....	25
------------------	----

## TP3® TRIANGULAR RECESS

### SHEET METAL SCREWS

Pan Head.....	25
---------------	----

## METRIC

### SNAKE EYES® SPANNERS MACHINE SCREWS

 Pan Head.....	26
Oval Head .....	26
Flat Head .....	26

### TORX® SECURITY MACHINE SCREWS

 Button Head.....	27
Flat Head .....	27

### SOCKET SECURITY MACHINE SCREWS

 Button Head.....	28
Flat Head .....	28

## STANDARD TORX (NON-TAMPERPROOF)

### SHEET METAL SCREWS

Pan Head.....	28
---------------	----

## TOOLS AND KITS

Spanner .....	29
Tri-Wing .....	30
Socket Pin-Head .....	30
Phillips Pin-Head .....	31
Torx Security .....	32
One-Way Removal Tools .....	33
TP3 .....	33
Complete Tool Kits.....	34



# GENERAL INFORMATION

## KEEP UNAUTHORIZED HANDS OFF YOUR EQUIPMENT!

**TAMPER-RESISTANT SECURITY SCREWS** can save you thousands of dollars—by fighting off pilferage, tampering, or unauthorized adjustments on scores of items.

We offer a complete line of corrosion-resistant security screws designed to prevent vandalism and theft, yet allow easy access by authorized personnel with the matching tools. **These screws are virtually impossible to remove without the special matching screwdrivers.**



## CONTACTING TAMPERPROOF

- **ADDRESS** — Tamperproof Screw Co., Inc.  
30 Laurel Street, Hicksville, N.Y. 11801
- **TELEPHONE** — 516-931-1616
- **FAX** — 516-931-1654
- **VISIT OUR WEB SITE** — [www.tamperproof.com](http://www.tamperproof.com)
- **EMAIL** — [sales@tamperproof.com](mailto:sales@tamperproof.com)

## TERMS AND CONDITIONS

All prices are NET and subject to change without notice.

**TERMS:** **NET 30 DAYS** with approved credit.  
All other orders are credit card or COD.  
Major credit cards accepted.



Minimum order \$25.00 (\$50.00 International)  
All payments made in U.S. dollars.  
Drop shipments incur \$2 service charge

**FREIGHT:** FOB Hicksville, NY

**RETURNS:** No returns accepted without prior permission.  
All authorized returns subject to restocking charge.

© Copyright 2006. All rights reserved. No part of this catalog may be reproduced in any form or any means including photocopying or used by any information storage or retrieval system without written authorization from Tamperproof Screw Co., Inc.

© Snake Eyes is a registered trademark of Tamperproof Screw Co., Inc.  
© Opsit is a registered trademark of Tamperproof Screw Co., Inc.  
© TP3 is a registered trademark of Tamperproof Screw Co., Inc.  
© Torx is a registered trademark of Camcar Div. of Textron, Inc.  
© Tri-Wing is a registered trademark of Phillips Screw Co.



TO ORDER CALL 516-931-1616 OR FAX 516-931-1654

## HOW TO ORDER

Placing your order is easy. When calling or faxing to place an order remember to specify the following:

### ■ TYPE OF SECURITY SCREW

*Example* — Spanner, Tri-Wing®, TP3®, etc.

### ■ HEAD STYLE

*Example* — Pan, Button, Flat, etc.

### ■ THREAD STYLE

*Example* — Machine, Self-Drilling or Sheet Metal.

### ■ SIZE AND LENGTH

*Example* — 4-40 diameter 1-1/2" length, etc.

### ■ QUANTITY

*Example* — 100 minimum per size, etc.

## TYPE OF SECURITY SCREW

We now offer eight different styles of tamper-resistant screws:

### ■ SNAKE EYES® SPANNER

### ■ PHILLIPS PIN-HEAD

### ■ ONE-WAY

### ■ OPSIT® REVERSE THREAD

### ■ SOCKET PIN-HEAD

### ■ TORX® SECURITY

### ■ TRI-WING®

### ■ TP3®



Select any style which best serves your needs.

**Most Screws are 18-8 Stainless Steel.**

Some Flat Head/Oval Head Spanner Machine Screws are available in Brass. Self-drilling Torx® Security are 410 Heat-Treated Stainless Steel. Consult your salesperson.

## MATCHING TOOLS

All screws\* require special matching tools for easy insertion and removal.

**Note:** Spanner and Pin-Head Tamper-Resistant Tools are NOT guaranteed against overtorque, misuse, breakage or wear and are not refundable.

\*One-Ways are easily installed with a standard screw driver. Removal may be possible with the "Un-Do-It" tools.

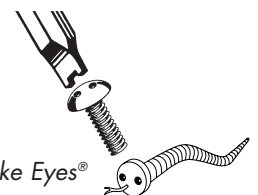

Manufacturers of Snake Eyes®

# TYPES OF SCREWS

## SNAKE EYES® SPANNERS

The original Snake Eyes® Spanner requires matching drive bit reducing the chances of unauthorized removal. Available in 18-8 stainless steel in a wide range of sizes and head styles. Some machine screws available in brass. Nuts are zinc alloy.

## PHILLIPS PIN-HEAD

Traditional Phillips drive with tamper-resistant pin added for security. Easy to drive & remove with matching tool. (Cannot be removed with Phillips Screwdriver.) Available in machine & sheet metal screws with flat or pan head design.

## ONE-WAY SLOTTED

Popular design installs with standard screwdriver. Reverse side cammed out to prevent unauthorized removal. Machine and sheet metal screws available in round, truss or oval head designs. Sex-bolts also available.

## OPSIT® REVERSE THREAD

Opsit® is a reverse thread sheet metal screw that installs counter-clockwise, thus, tightens if removal is attempted. Available with a low profile truss head and Tri-Wing® drive.

## SOCKET PIN-HEAD

Engineered for a high degree of tamper-resistance offering positive engaging, high torque transmission while resisting cam-out and tool wear. Available in button & flat head design or set screws (special order). Matching drive bit required for installation and removal.

## TORX® PIN-HEAD

Maximum torque transfer & positive tool engagement means easier drive installation with less pressure & slippage. Torx® Pin-Head offers a high degree of security & requires matching drive bit. Available in Button & Flat-Head machine screws & Button, Flat & Pan-head design sheet metal screws.

## TRI-WING®

Economical Tri-Wing® tamper-resistant screws are the common choice for high volume assembly operations while offering a minimal degree of security. Machine & sheet metal screws are offered in a Pan-Head design and Opsit® reverse thread.

## TP3® TRIANGULAR

New trilobular drive offers a high degree of security requiring matching tool bit.

## HEAD STYLES

 **PAN**  
Features a low profile, large diameter head with a high-edged crown for increased strength.

 **FLAT**  
Installs flush with countersunk materials for clean appearance.

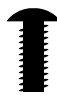
 **TRUSS**  
Low profile offers added security. Large diameter head for increased fastening strength.

 **ROUND**  
One-Way screws only. Features a high crown with a deep recess & smaller diameter head than our Truss or Pan Head designs.

 **OVAL**  
Used where countersink installation is desired. Rounded head offers deep recess & is visible just above the surface.

 **BUTTON**  
Also used for general purposes with a lower crown & shallower recess than our Round Head design.

## THREAD STYLES

 **SHEET METAL A OR AB**  
Thread forming screw with locating point.

 **MACHINE MS**  
Machine screw standard thread, straight sheared point.

 **SELF DRILLING**  
Type AB thread with a 410 heat treated stainless steel, #2 self-drilling point.



# SNAKE EYES®



## PAN HEAD/MACHINE SCREWS

1 8 - 8 STAINLESS STEEL

DIAMETER	LENGTH	PART NO.	PRICE CODE	DRIVER SIZE
<b>4-40</b>	1/4	1.44014PS	A9	<b>4</b>
	3/8	1.44038PS	A9	
	1/2	1.44012PS	A9	
	5/8	1.44058PS	A9	
	3/4	1.44034PS	A9	
	1	1.4401PS	A9	
	1-1/4	1.440114PS	B1	
	1-1/2	1.440112PS	B3	

DIAMETER	LENGTH	PART NO.	PRICE CODE	DRIVER SIZE
<b>6-32</b>	1/4	1.63214PS	A9	<b>6</b>
	3/8	1.63238PS	A9	
	1/2	1.63212PS	A9	
	5/8	1.63258PS	A9	
	3/4	1.63234PS	A9	
	1	1.6321PS	A9	
	1-1/4	1.632114PS	B1	
	1-1/2	1.632112PS	B3	
	2	1.6322PS	B4	
3	1.6323PS	D1		

DIAMETER	LENGTH	PART NO.	PRICE CODE	DRIVER SIZE
<b>8-32</b>	1/4	1.83214PS	B1	<b>8</b>
	3/8	1.83238PS	B1	
	1/2	1.83212PS	B1	
	5/8	1.83258PS	B1	
	3/4	1.83234PS	B1	
	1	1.8321PS	B1	
	1-1/4	1.832114PS	B3	
	1-1/2	1.832112PS	B4	
	2	1.8322PS	B8	
	2-1/2	1.832212PS	C3	
	3	1.8323PS	C6	

DIAMETER	LENGTH	PART NO.	PRICE CODE	DRIVER SIZE
<b>10-32</b>	1/4	1.10314PS	B3	<b>10</b>
	3/8	1.10338PS	B3	
	1/2	1.10312PS	B3	
	5/8	1.10358PS	B3	
	3/4	1.10334PS	B3	
	1	1.1031PS	B3	
	1-1/4	1.103114PS	B5	
	1-1/2	1.103112PS	B8	
	2	1.1032PS	C3	

DIAMETER	LENGTH	PART NO.	PRICE CODE	DRIVER SIZE
<b>10-24</b>	1/4	1.10214PS	B3	<b>10</b>
	3/8	1.10238PS	B3	
	1/2	1.10212PS	B3	
	5/8	1.10258PS	B3	
	3/4	1.10234PS	B3	
	1	1.1021PS	B3	
	1-1/4	1.102114PS	B5	
	1-1/2	1.102112PS	B8	
	2	1.1022PS	C3	
	3	1.1023PS	D1	

DIAMETER	LENGTH	PART NO.	PRICE CODE	DRIVER SIZE
<b>12-24</b>	1/4	1.12214PS	B8	<b>12</b>
	1/2	1.12212PS	B8	
	3/4	1.12234PS	B8	
	1	1.1221PS	B8	
	1-1/4	1.122114PS	C1	
	1-1/2	1.122112PS	C3	

DIAMETER	LENGTH	PART NO.	PRICE CODE	DRIVER SIZE
<b>1/4-20</b>	3/8	1.14238PS	C2	<b>1/4</b>
	1/2	1.14212PS	C2	
	5/8	1.14258PS	C2	
	3/4	1.14234PS	C2	
	1	1.1421PS	C3	
	1-1/4	1.142114PS	C4	
	1-1/2	1.142112PS	C6	
	2	1.1422PS	C8	
	2-1/4	1.142214PS	D1	
	2-1/2	1.142212PS	D4	
	3	1.1423PS	D8	
	4	1.1424PS	E3	

DIAMETER	LENGTH	PART NO.	PRICE CODE	DRIVER SIZE
<b>1/4-28</b>	1/2	1.14812PS	C3	<b>1/4</b>
	5/8	1.14858PS	C3	
	3/4	1.14834PS	C3	
	1	1.1481PS	C5	
	1-1/2	1.148112PS	C6	



**ALL PRICES PER 100**

See page 29 for matching tools.

**TAMPERPROOF**  
SCREW CO., INC. OF NEW YORK

TO ORDER CALL 516-931-1616 OR FAX 516-931-1654

Manufacturers of Snake Eyes®

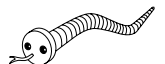



## TRUSS HEAD/MACHINE SCREWS

1 8 - 8 S T A I N L E S S S T E E L

DIAMETER	LENGTH	PART NO.	PRICE CODE	DRIVER SIZE
<b>6-32</b>	3/8	1.63238TS	A9	<b>6</b>
	1/2	1.63212TS	A9	
	3/4	1.63234TS	A9	
	1	1.6321TS	A9	

DIAMETER	LENGTH	PART NO.	PRICE CODE	DRIVER SIZE
<b>8-32</b>	1/2	1.83212TS	B1	<b>8</b>
	5/8	1.83258TS	B1	
	3/4	1.83234TS	B1	
	1	1.8321TS	B1	
	1-1/4	1.832114TS	B3	
	1-1/2	1.832112TS	B4	
	2-1/2	1.832212TS	C3	

DIAMETER	LENGTH	PART NO.	PRICE CODE	DRIVER SIZE
<b>10-32</b>	1/2	1.10312TS	B3	<b>10</b>
	5/8	1.10358TS	B3	
	3/4	1.10334TS	B3	
	1	1.1031TS	B3	
	1-1/2	1.103112TS	B8	

DIAMETER	LENGTH	PART NO.	PRICE CODE	DRIVER SIZE
<b>10-24</b>	1/2	1.10212TS	B3	<b>10</b>
	3/4	1.10234TS	B3	
	1	1.1021TS	B3	
	1-1/2	1.102112TS	B8	
	1-3/4	1.102134TS	C1	

DIAMETER	LENGTH	PART NO.	PRICE CODE	DRIVER SIZE
<b>1/4-20</b>	3/8	1.14238TS	C2	<b>1/4</b>
	1/2	1.14212TS	C2	
	3/4	1.14234TS	C2	
	1	1.1421TS	C3	
	1-1/4	1.142114TS	C4	
	1-1/2	1.142112TS	C6	
	2	1.1422TS	C8	

DIAMETER	LENGTH	PART NO.	PRICE CODE	DRIVER SIZE
<b>5/16-18</b>	3/4	1.51634TS	C9	<b>1/4</b>
	1	1.5161TS	D1	
	1-1/4	1.516114TS	D4	
	1-1/2	1.516112TS	D8	
	2	1.5162TS	D8	
	2-1/2	1.516212TS	E1	
	3	1.5163TS	E4	

DIAMETER	LENGTH	PART NO.	PRICE CODE	DRIVER SIZE
<b>3/8-16</b>	1/2	1.38612TS	D8	<b>1/4</b>
	5/8	1.38658TS	D8	
	3/4	1.38634TS	D8	
	1	1.3861TS	E1	
	1-1/4	1.386114TS	E1	
	1-1/2	1.386112TS	E3	
	2	1.3862TS	E3	
	2-1/2	1.386212TS	E5	
	3	1.3863TS	E6	
	3-1/2	1.386312TS	E7	



## FLAT HEAD/MACHINE SCREWS

1 8 - 8 S T A I N L E S S S T E E L

DIAMETER	LENGTH	PART NO.	PRICE CODE	DRIVER SIZE
<b>4-40</b>	1/4	1.44014FS	A9	<b>4</b>
	3/8	1.44038FS	A9	
	1/2	1.44012FS	A9	
	1	1.4401FS	A9	
	1-1/2	1.440112FS	B3	

DIAMETER	LENGTH	PART NO.	PRICE CODE	DRIVER SIZE
<b>6-32</b>	3/16 UC	1.632316UFS	A9	<b>6</b>
	1/4 UC	1.63214UFS	A9	
	1/4	1.63214FS	A9	
	3/8	1.63238FS	A9	
	1/2	1.63212FS	A9	
	5/8	1.63258FS	A9	
	3/4	1.63234FS	A9	
	1	1.6321FS	A9	
	1-1/4	1.632114FS	B1	
	1-1/2	1.632112FS	B3	
	2	1.6322FS	B4	
	3	1.6323FS	D1	

Note: "UC" denotes undercut head.



Standard Flat Head



Undercut Flat Head

### QUANTITY DISCOUNTS ON SPANNER SCREWS

(Per Size) At 1m screws: less 10% • At 5m screws: less 20% • At 10m screws: less 30%





# SNAKE EYES®



## FLAT HEAD/MACHINE SCREWS (CON'T)

1 8 - 8 STAINLESS STEEL

DIAMETER	LENGTH	PART NO.	PRICE CODE	DRIVER SIZE
<b>8-32</b>	1/4 UC	1.83214UFS	B1	<b>8</b>
	5/16 UC	1.832516UFS	B1	
	3/8 UC	1.83238UFS	B1	
	3/8	1.83238FS	B1	
	1/2 UC	1.83212UFS	B1	
	1/2	1.83212FS	B1	
	5/8 UC	1.83258UFS	B1	
	3/4	1.83234FS	B1	
	1	1.8321FS	B1	
	1-1/4	1.832114FS	B3	
	1-1/2	1.832112FS	B4	
	1-3/4	1.832134FS	B5	
	2	1.8322FS	B8	
	2-1/2	1.832212FS	C3	
3	1.8323FS	C6		

DIAMETER	LENGTH	PART NO.	PRICE CODE	DRIVER SIZE
<b>10-32</b>	3/8 UC	1.10338UFS	B3	<b>10</b>
	1/2 UC	1.10312UFS	B3	
	1/2	1.10312FS	B3	
	5/8	1.10358FS	B3	
	3/4	1.10334FS	B3	
	1	1.1031FS	B3	
	1-1/4	1.103114FS	B5	
	1-1/2	1.103112FS	B8	
	2	1.1032FS	C3	
	3	1.1033FS	D1	

DIAMETER	LENGTH	PART NO.	PRICE CODE	DRIVER SIZE
<b>10-24</b>	5/16 UC	1.102516UFS	B3	<b>10</b>
	3/8 UC	1.10238UFS	B3	
	3/8	1.10238FS	B3	
	1/2 UC	1.10212UFS	B3	
	1/2	1.10212FS	B3	
	5/8	1.10258FS	B3	
	3/4	1.10234FS	B3	
	1	1.1021FS	B3	
	1-1/4	1.102114FS	B5	
	1-1/2	1.102112FS	B8	
	2	1.1022FS	C3	
	2-1/2	1.102212FS	C6	
	3	1.1023FS	D1	

Note: "UC" denotes undercut head.

DIAMETER	LENGTH	PART NO.	PRICE CODE	DRIVER SIZE
<b>12-24</b>	1/2 UC	1.12212UFS	B8	<b>12</b>
	3/4	1.12234FS	B8	
	1	1.1221FS	B8	
	1-1/2	1.122112FS	C3	
	2	1.1222FS	C6	

DIAMETER	LENGTH	PART NO.	PRICE CODE	DRIVER SIZE
<b>1/4-20</b>	3/8 UC	1.14238UFS	C2	<b>1/4</b>
	1/2 UC	1.14212UFS	C2	
	1/2	1.14212FS	C2	
	5/8	1.14258FS	C2	
	3/4	1.14234FS	C2	
	7/8	1.14278FS	C3	
	1	1.1421FS	C3	
	1-1/4	1.142114FS	C4	
	1-1/2	1.142112FS	C6	
	2	1.1422FS	C8	
	2-1/4	1.142214FS	D1	
	2-1/2	1.142212FS	D4	
	3	1.1423FS	D8	
4	1.1424FS	E3		

DIAMETER	LENGTH	PART NO.	PRICE CODE	DRIVER SIZE
<b>1/4-28</b>	1/2	1.14812FS	C3	<b>1/4</b>
	3/4	1.14834FS	C3	
	1	1.1481FS	C5	
	1-1/2	1.148112FS	C6	

DIAMETER	LENGTH	PART NO.	PRICE CODE	DRIVER SIZE
<b>5/16-18</b>	3/4	1.51634FS	C9	<b>1/4</b>
	1	1.5161FS	D1	
	1-1/2	1.516112FS	D8	
	2	1.5162FS	D8	
	2-1/2	1.516212FS	E1	
	3	1.5163FS	E4	

DIAMETER	LENGTH	PART NO.	PRICE CODE	DRIVER SIZE
<b>3/8-16</b>	1/2 UC	1.38612UFS	E1	<b>1/4</b>
	3/4	1.38634FS	E1	
	1 UC	1.3861UFS	E1	
	1	1.3861FS	E1	
	1-1/2	1.386112FS	E3	
	2	1.3862FS	E3	
	2-1/2	1.386212FS	E5	
	3	1.3863FS	E6	



**ALL PRICES PER 100**

See page 29 for matching tools.

**TAMPERPROOF**  
SCREW CO., INC. OF NEW YORK

TO ORDER CALL 516-931-1616 OR FAX 516-931-1654

Manufacturers of Snake Eyes®

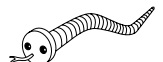



## FLAT HEAD/MACHINE SCREWS

**B R A S S**

DIAMETER	LENGTH	PART NO.	PRICE CODE	DRIVER SIZE
<b>6-32</b>	3/16 UC	1.632316UFB	B3	<b>6</b>
	3/8	1.63238FB	B3	
	1/2	1.63212FB	B3	
	3/4	1.63234FB	B3	
	1	1.6321FB	B3	

DIAMETER	LENGTH	PART NO.	PRICE CODE	DRIVER SIZE
<b>8-32</b>	1/4 UC	1.83214UFB	B4	<b>8</b>
	5/16 UC	1.832516UFB	B4	
	1/2	1.83212FB	B4	
	3/4	1.83234FB	B4	
	1	1.8321FB	B4	
1-1/2	1.832112FB	B5		

DIAMETER	LENGTH	PART NO.	PRICE CODE	DRIVER SIZE
<b>10-24</b>	3/8	1.10238FB	B5	<b>10</b>
	1/2	1.10212FB	B5	
	3/4	1.10234FB	B5	
	1	1.1021FB	B5	
	1-1/2	1.102112FB	B8	
2	1.1022FB	C1		

DIAMETER	LENGTH	PART NO.	PRICE CODE	DRIVER SIZE
<b>12-24</b>	1/2 UC*	1.12212UFC	C1	<b>12</b>

DIAMETER	LENGTH	PART NO.	PRICE CODE	DRIVER SIZE
<b>1/4-20</b>	1/2	1.14212FB	C3	<b>1/4</b>
	3/4	1.14234FB	C3	
	1	1.1421FB	C3	
	1-1/4	1.142114FB	C6	
	1-1/2	1.142112FB	C6	

\*Note: Available in Silicon Bronze only.

Note: "UC" denotes undercut head.



Standard Flat Head



Undercut Flat Head



## OVAL HEAD/MACHINE SCREWS

**1 8 - 8 S T A I N L E S S S T E E L**

DIAMETER	LENGTH	PART NO.	PRICE CODE	DRIVER SIZE
<b>6-32</b>	1/4 UC	1.63214UOS	B3	<b>6</b>
	5/16 UC	1.632516UOS	B3	
	3/8 UC	1.63238UOS	B3	
	3/8	1.63238OS	B3	
	1/2	1.63212OS	B3	
	5/8	1.63258OS	B3	
	3/4	1.63234OS	B3	
	1	1.6321OS	B3	
	1-1/4	1.632114OS	B4	
	1-1/2	1.632112OS	B5	
	2	1.6322OS	B9	

DIAMETER	LENGTH	PART NO.	PRICE CODE	DRIVER SIZE
<b>8-32</b>	1/2	1.83212OS	B4	<b>8</b>
	3/4	1.83234OS	B4	
	1	1.8321OS	B4	
	1-1/4	1.832114OS	B5	
	1-3/8	1.832138OS	B7	
	1-1/2	1.832112OS	B7	
	2	1.8322OS	C2	
	2-1/2	1.832212OS	C6	

DIAMETER	LENGTH	PART NO.	PRICE CODE	DRIVER SIZE
<b>10-32</b>	1/2	1.10312OS	B5	<b>10</b>
	5/8	1.10358OS	B5	
	3/4	1.10334OS	B5	
	1	1.1031OS	B5	
	1-1/4	1.103114OS	B7	
	1-1/2	1.103112OS	B9	
	2	1.1032OS	C6	

DIAMETER	LENGTH	PART NO.	PRICE CODE	DRIVER SIZE
<b>10-24</b>	3/8	1.10238OS	B5	<b>10</b>
	1/2	1.10212OS	B5	
	5/8	1.10258OS	B5	
	3/4	1.10234OS	B5	
	1	1.1021OS	B5	
	1-1/4	1.102114OS	B7	
	1-1/2	1.102112OS	B9	
2	1.1022OS	C6		

DIAMETER	LENGTH	PART NO.	PRICE CODE	DRIVER SIZE
<b>1/4-20</b>	1	1.1421OS	C4	<b>1/4</b>
	1-1/2	1.142112OS	C6	
	2	1.1422OS	C8	

### QUANTITY DISCOUNTS ON SPANNER SCREWS

(Per Size) At 1m screws: less 10% • At 5m screws: less 20% • At 10m screws: less 30%



**TAMPERPROOF**  
SCREW CO., INC. OF NEW YORK





# SNAKE EYES®

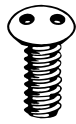

## OVAL HEAD/MACHINE SCREWS

**B R A S S**

DIAMETER	LENGTH	PART NO.	PRICE CODE	DRIVER SIZE
<b>6-32</b>	3/8	1.63238OB	B5	<b>6</b>
	1/2	1.63212OB	B5	
	3/4	1.63234OB	B5	
	1	1.63210B	B5	

DIAMETER	LENGTH	PART NO.	PRICE CODE	DRIVER SIZE
<b>8-32</b>	1/2	1.83212OB	B7	<b>8</b>
	3/4	1.83234OB	B7	
	1	1.83210B	B7	
	1-1/4	1.832114OB	B9	
	1-1/2	1.832112OB	B9	
2	1.83220B	C2		

DIAMETER	LENGTH	PART NO.	PRICE CODE	DRIVER SIZE
<b>10-32</b>	1/2	1.10312OB	B9	<b>10</b>
	5/8	1.10358OB	B9	
	3/4	1.10334OB	B9	
	1	1.10310B	B9	
	1-1/4	1.103114OB	C2	
	1-1/2	1.103112OB	C2	
	2	1.10320B	C7	

DIAMETER	LENGTH	PART NO.	PRICE CODE	DRIVER SIZE
<b>10-24</b>	3/8	1.10238OB	B9	<b>10</b>
	1/2	1.10212OB	B9	
	3/4	1.10234OB	B9	
	1	1.10210B	C2	
	1-1/2	1.102112OB	C7	
	2	1.10220B	C7	

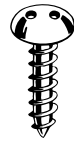

## TRUSS HEAD/ SHEET METAL SCREWS

**TYPE A, 18-8 STAINLESS STEEL**

DIAMETER	LENGTH	PART NO.	PRICE CODE	DRIVER SIZE
<b>#8</b>	1/2	1.8A12TS	B1	<b>8</b>
	3/4	1.8A34TS	B1	
	1	1.8A1TS	B1	
	1-1/4	1.8A114TS	B3	
	1-1/2	1.8A112TS	B4	

DIAMETER	LENGTH	PART NO.	PRICE CODE	DRIVER SIZE
<b>#10</b>	3/8*	1.10AB38TS	B3	<b>10</b>
	1/2	1.10A12TS	B3	
	3/4	1.10A34TS	B3	
	1	1.10A1TS	B3	
	1-1/4	1.10A114TS	B5	
	1-1/2	1.10A112TS	B8	
	2	1.10A2TS	C1	

\*Note: Sheet Metal Screws Type AB.



**ALL PRICES PER 100**

See page 29 for matching tools.

**TAMPERPROOF**  
SCREW CO., INC. OF NEW YORK

TO ORDER CALL 516-931-1616 OR FAX 516-931-1654

Manufacturers of Snake Eyes®

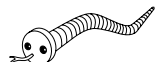



## PAN HEAD/SHEET METAL SCREWS

TYPE A, 18-8 STAINLESS STEEL

DIAMETER	LENGTH	PART NO.	PRICE CODE	DRIVER SIZE
#4	1/4	1.4A14PS	A9	4
	3/8	1.4A38PS	A9	
	1/2	1.4A12PS	A9	
	3/4	1.4A34PS	B1	
	1	1.4A1PS	B3	

DIAMETER	LENGTH	PART NO.	PRICE CODE	DRIVER SIZE
#6	1/4*	1.6AB14PS	A9	6
	3/8	1.6A38PS	A9	
	1/2	1.6A12PS	A9	
	5/8	1.6A58PS	A9	
	3/4	1.6A34PS	A9	
	1	1.6A1PS	A9	
	1-1/4	1.6A114PS	B1	
	1-1/2	1.6A112PS	B3	
	2	1.6A2PS	B4	

DIAMETER	LENGTH	PART NO.	PRICE CODE	DRIVER SIZE
#8	3/8*	1.8AB38PS	B1	8
	1/2	1.8A12PS	B1	
	5/8	1.8A58PS	B1	
	3/4	1.8A34PS	B1	
	1	1.8A1PS	B1	
	1-1/4	1.8A114PS	B4	
	1-1/2	1.8A112PS	B4	
	1-3/4	1.8A134PS	B7	
	2	1.8A2PS	B8	

DIAMETER	LENGTH	PART NO.	PRICE CODE	DRIVER SIZE
#10	3/8*	1.10AB38PS	B3	10
	1/2	1.10A12PS	B3	
	5/8	1.10A58PS	B3	
	3/4	1.10A34PS	B3	
	1	1.10A1PS	B3	
	1-1/4	1.10A114PS	B5	
	1-1/2	1.10A112PS	B8	
	1-3/4	1.10A134PS	C1	
	2	1.10A2PS	C1	

\*Note: Sheet Metal Screws Type AB.

DIAMETER	LENGTH	PART NO.	PRICE CODE	DRIVER SIZE
#12	1/2	1.12A12PS	B8	12
	3/4	1.12A34PS	B8	
	1	1.12A1PS	B8	
	1-1/4	1.12A114PS	C1	
	1-1/2	1.12A112PS	C1	
	2	1.12A2PS	C6	

DIAMETER	LENGTH	PART NO.	PRICE CODE	DRIVER SIZE
#14	1/2*	1.14AB12PS	C2	1/4
	3/4	1.14A34PS	C2	
	1	1.14A1PS	C2	
	1-1/4	1.14A114PS	C4	
	1-1/2	1.14A112PS	C5	
	2	1.14A2PS	C6	



## FLAT HEAD/SHEET METAL SCREWS

TYPE A, 18-8 STAINLESS STEEL

DIAMETER	LENGTH	PART NO.	PRICE CODE	DRIVER SIZE
#4	1/4 UC*	1.4AB14UFS	A9	4
	3/8	1.4A38FS	A9	
	1/2	1.4A12FS	A9	
	3/4	1.4A34FS	B1	
	1	1.4A1FS	B3	

DIAMETER	LENGTH	PART NO.	PRICE CODE	DRIVER SIZE
#6	3/8*	1.6AB38FS	A9	6
	1/2	1.6A12FS	A9	
	5/8	1.6A58FS	A9	
	3/4	1.6A34FS	A9	
	1	1.6A1FS	A9	
	1-1/4	1.6A114FS	B1	
	1-1/2	1.6A112FS	B3	
	2	1.6A2FS	B4	

Note: "UC" denotes undercut head.

\*Note: Sheet Metal Screws Type AB.

### QUANTITY DISCOUNTS ON SPANNER SCREWS

(Per Size) At 1m screws: less 10% • At 5m screws: less 20% • At 10m screws: less 30%





# SNAKE EYES®



## FLAT HEAD/ SHEET METAL SCREWS (CON'T)

TYPE A, 18-8 STAINLESS STEEL

DIAMETER	LENGTH	PART NO.	PRICE CODE	DRIVER SIZE
#8	3/8 UC	1.8A38UFS	B1	8
	1/2	1.8A12FS	B1	
	5/8	1.8A58FS	B1	
	3/4	1.8A34FS	B1	
	1	1.8A1FS	B1	
	1-1/4	1.8A114FS	B3	
	1-1/2	1.8A112FS	B4	
	2	1.8A2FS	B8	

DIAMETER	LENGTH	PART NO.	PRICE CODE	DRIVER SIZE
#10	1/2 UC *	1.10AB12UFS	B3	10
	5/8	1.10A58FS	B3	
	3/4	1.10A34FS	B3	
	1	1.10A1FS	B3	
	1-1/4	1.10A114FS	B5	
	1-1/2	1.10A112FS	B8	
	1-3/4	1.10A134FS	C1	
	2	1.10A2FS	C1	

DIAMETER	LENGTH	PART NO.	PRICE CODE	DRIVER SIZE
#12	1/2 UC	1.12A12UFS	B8	12
	3/4	1.12A34FS	B8	
	1	1.12A1FS	B8	
	1-1/4	1.12A114FS	C1	
	1-1/2	1.12A112FS	C1	
	2	1.12A2FS	C6	

DIAMETER	LENGTH	PART NO.	PRICE CODE	DRIVER SIZE
#14	1/2 UC	1.14A12UFS	C3	14
	3/4	1.14A34FS	C3	
	1	1.14A1FS	C3	
	1-1/4	1.14A114FS	C4	
	1-1/2	1.14A112FS	C5	
	2	1.14A2FS	C6	

\*Note: Sheet Metal Screws Type AB.

Note: "UC" denotes undercut head.



## OVAL HEAD/SHEET METAL SCREWS

TYPE A, 18-8 STAINLESS STEEL

DIAMETER	LENGTH	PART NO.	PRICE CODE	DRIVER SIZE
#6	1/2	1.6A12OS	B4	6
	5/8 UC	1.6A58UOS	B4	
	3/4	1.6A34OS	B4	
	1	1.6A1OS	B4	
	1-1/4	1.6A114OS	B5	
	1-1/2	1.6A112OS	B7	

DIAMETER	LENGTH	PART NO.	PRICE CODE	DRIVER SIZE
#8	1/2	1.8A12OS	B5	8
	3/4	1.8A34OS	B5	
	1	1.8A1OS	B5	
	1-1/4	1.8A114OS	B7	
	1-1/2	1.8A112OS	B9	
	2	1.8A2OS	C2	

DIAMETER	LENGTH	PART NO.	PRICE CODE	DRIVER SIZE
#10	1/2 UC	1.10A12UOS	B7	10
	3/4	1.10A34OS	B7	
	1	1.10A1OS	B7	
	1-1/4	1.10A114OS	B9	
	1-1/2	1.10A112OS	C2	

Note: "UC" denotes undercut head.



**ALL PRICES PER 100**

See page 29 for matching tools.

**TAMPERPROOF**  
SCREW CO., INC. OF NEW YORK

TO ORDER CALL 516-931-1616 OR FAX 516-931-1654

Manufacturers of Snake Eyes®

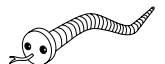

# NUTS

## SPANNER NUTS/REMOVABLE

ZINC ALLOY (NON-FERROUS RUST RESISTANT)

DIAMETER	PART NO.	PRICE CODE	DRIVER SIZE
1/4-20	IN.142	E4	1ND
5/16-18	IN.516	E4	
3/8-16	IN.386	E4	
M6	IN.M6	E4	
M8	IN.M8	E4	
M10	IN.M10	E4	

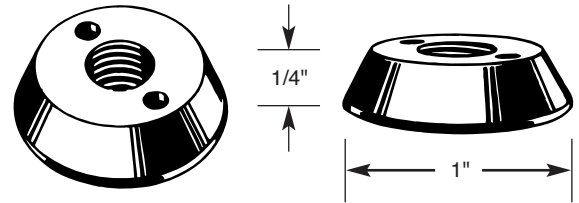

Spanner Nuts

## SPANNER NUT BIT

SIZE	PART NO.	PRICE CODE
Bit Only (1/4" Hex)	1NB.14	S6
Bit Only (5/16" Hex)	1NB.516	S6

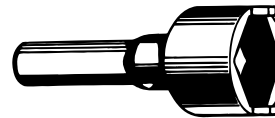

Spanner Nut Bit

## SPANNER NUT DRIVER COMPLETE

	PART NO.	PRICE CODE
Driver	1ND	T2

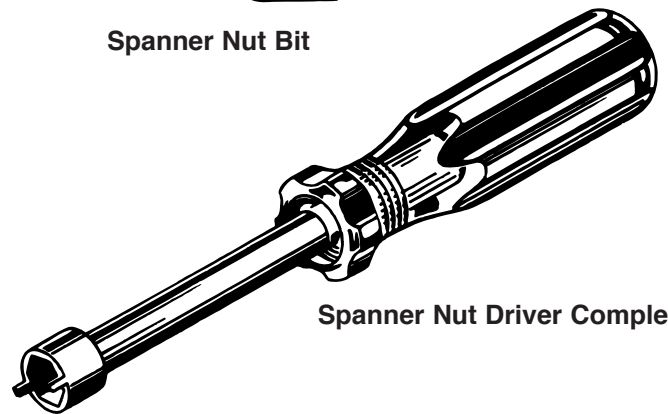

Spanner Nut Driver Complete

## BREAKAWAY NUTS/ NON-REMOVABLE

ALUMINUM

DIAMETER	PART NO.	SIZE	PRICE CODE
10-24	BAN.102	7/16" Hex	C6
1/4-20	BAN.142	9/16" Hex	D1
5/16-18	BAN.516	5/8" Hex	D4
3/8-16	BAN.386	3/4" Hex	E3

Note: Uses standard wrench for installation

Breakaway Nuts

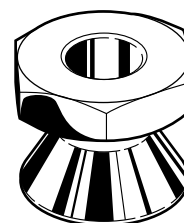

Before

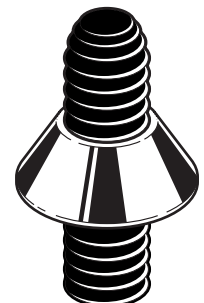

After

QUANTITY DISCOUNTS ON NUTS AVAILABLE UPON REQUEST



FOR ADDITIONAL INFORMATION LOG ON TO [WWW.TAMPERPROOF.COM](http://WWW.TAMPERPROOF.COM)

**TAMPERPROOF**  
SCREW CO., INC. OF NEW YORK



# SOCKET SECURITY

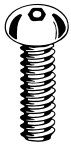

## BUTTON HEAD/CAP SCREWS

1 8 - 8 S T A I N L E S S S T E E L

DIAMETER	LENGTH	PART NO.	PRICE CODE	DRIVER SIZE
<b>6-32</b>	1/4	6.63214BS	B4	<b>1/8"</b>
	3/8	6.63238BS	B4	
	1/2	6.63212BS	B4	
	3/4	6.63234BS	B4	
	1	6.6321BS	B4	

DIAMETER	LENGTH	PART NO.	PRICE CODE	DRIVER SIZE
<b>8-32</b>	3/8	6.83238BS	B8	<b>1/8"</b>
	1/2	6.83212BS	B8	
	3/4	6.83234BS	B8	
	1	6.8321BS	B8	
	1-1/2	6.832112BS	D5	

DIAMETER	LENGTH	PART NO.	PRICE CODE	DRIVER SIZE
<b>10-32</b>	1/4	6.10314BS	B8	<b>5/32"</b>
	3/8	6.10338BS	B8	
	1/2	6.10312BS	B8	
	5/8	6.10358BS	C1	
	3/4	6.10334BS	C1	
	1	6.1031BS	C1	
	1-1/4	6.103114BS	D4	
	1-1/2	6.103112BS	D4	
2	6.1032BS	E4		

DIAMETER	LENGTH	PART NO.	PRICE CODE	DRIVER SIZE
<b>10-24</b>	1/4	6.10214BS	C1	<b>5/32"</b>
	3/8	6.10238BS	B8	
	1/2	6.10212BS	B8	
	3/4	6.10234BS	C1	
	1	6.1021BS	C1	
	1-1/2	6.102112BS	D4	
	2	6.1022BS	E4	

DIAMETER	LENGTH	PART NO.	PRICE CODE	DRIVER SIZE
<b>1/4-20</b>	1/2	6.14212BS	C6	<b>5/32"</b>
	5/8	6.14258BS	C6	
	3/4	6.14234BS	C6	
	1	6.1421BS	D1	
	1-1/4	6.142114BS	D1	
	1-1/2	6.142112BS	D4	
	2	6.1422BS	E3	

DIAMETER	LENGTH	PART NO.	PRICE CODE	DRIVER SIZE
<b>1/4-28</b>	1/2	6.14812BS	D4	<b>5/32"</b>
	3/4	6.14834BS	D4	
	1	6.1481BS	D4	

DIAMETER	LENGTH	PART NO.	PRICE CODE	DRIVER SIZE
<b>5/16-18</b>	3/8	6.51638BS	E3	<b>3/16"</b>
	1/2	6.51612BS	E3	
	3/4	6.51634BS	E3	
	1	6.5161BS	E3	
	1-1/4	6.516114BS	E5	
	1-1/2	6.516112BS	E5	
	2	6.5162BS	E5	

DIAMETER	LENGTH	PART NO.	PRICE CODE	DRIVER SIZE
<b>3/8-16</b>	1/2	6.38612BS	E8	<b>7/32"</b>
	3/4	6.38634BS	E8	
	1	6.3861BS	E8	
	1-1/4	6.386114BS	E8	
	1-1/2	6.386112BS	E8	
	2	6.3862BS	E9	

DIAMETER	LENGTH	PART NO.	PRICE CODE	DRIVER SIZE
<b>1/2-13</b>	1	6.1231BS	F1	<b>5/16"</b>
	1-1/2	6.123112BS	F2	
	2	6.1232BS	F3	
	2-1/2	6.123212BS	F3	
	3	6.1233BS	F4	
	3-1/2	6.123312BS	F5	



## SET SCREWS

Special order only. Consult your salesperson.



**ALL PRICES PER 100**

See pages 30 and 31 for matching tools.

**TAMPERPROOF**  
SCREW CO., INC. OF NEW YORK

TO ORDER CALL 516-931-1616 OR FAX 516-931-1654

Manufacturers of Snake Eyes®

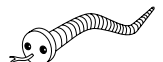

# SOCKET SECURITY



## FLAT HEAD/CAP SCREWS

18 - 8 STAINLESS STEEL

DIAMETER	LENGTH	PART NO.	PRICE CODE	DRIVER SIZE
<b>6-32</b>	3/8	6.63238FS	B4	<b>1/8"</b>
	1/2	6.63212FS	B4	
	3/4	6.63234FS	B4	
	1	6.6321FS	B4	

DIAMETER	LENGTH	PART NO.	PRICE CODE	DRIVER SIZE
<b>8-32</b>	3/8	6.83238FS	B8	<b>1/8"</b>
	1/2	6.83212FS	B8	
	3/4	6.83234FS	B8	
	1	6.8321FS	B8	

DIAMETER	LENGTH	PART NO.	PRICE CODE	DRIVER SIZE
<b>10-32</b>	1/2	6.10312FS	C6	<b>5/32"</b>
	3/4	6.10334FS	C6	
	1	6.1031FS	C6	
	1-1/2	6.103112FS	E3	

DIAMETER	LENGTH	PART NO.	PRICE CODE	DRIVER SIZE
<b>10-24</b>	3/8	6.10238FS	C6	<b>5/32"</b>
	1/2	6.10212FS	C6	
	3/4	6.10234FS	C6	
	1	6.1021FS	C6	
	1-1/2	6.102112FS	E3	

DIAMETER	LENGTH	PART NO.	PRICE CODE	DRIVER SIZE
<b>12-24</b>	1/2 UC	6.12212UFS	C6	<b>5/32"</b>

DIAMETER	LENGTH	PART NO.	PRICE CODE	DRIVER SIZE
<b>1/4-20</b>	1/2	6.14212FS	D1	<b>5/32"</b>
	3/4	6.14234FS	D1	
	1	6.1421FS	D4	
	1-1/4	6.142114FS	D4	
	1-1/2	6.142112FS	D8	
	2	6.1422FS	E5	

DIAMETER	LENGTH	PART NO.	PRICE CODE	DRIVER SIZE
<b>5/16-18</b>	1/2	6.51612FS	E7	<b>3/16"</b>
	3/4	6.51634FS	E7	
	1	6.5161FS	E7	
	1-1/4	6.516114FS	E7	
	1-1/2	6.516112FS	E7	
	2	6.5162FS	E7	

DIAMETER	LENGTH	PART NO.	PRICE CODE	DRIVER SIZE
<b>3/8-16</b>	1/2	6.38612FS	E8	<b>7/32"</b>
	3/4	6.38634FS	E8	
	1	6.3861FS	E8	
	1-1/4	6.386114FS	E8	
	1-1/2	6.386112FS	E8	
	2	6.3862FS	E9	



## BUTTON HEAD/ SHEET METAL SCREWS

TYPE AB, 18 - 8 STAINLESS STEEL

DIAMETER	LENGTH	PART NO.	PRICE CODE	DRIVER SIZE
<b>#8</b>	1/2	6.8AB12BS	C3	<b>1/8"</b>
	3/4	6.8AB34BS	C3	
	1	6.8AB1BS	C3	

DIAMETER	LENGTH	PART NO.	PRICE CODE	DRIVER SIZE
<b>#10</b>	1/2	6.10AB12BS	C3	<b>5/32"</b>
	3/4	6.10AB34BS	C3	
	1	6.10AB1BS	C3	
	1-1/2	6.10AB112BS	E1	

### QUANTITY DISCOUNTS ON SOCKET SECURITY SCREWS

(Per Size) At 1m screws: less 10% • At 5m screws: less 20% • At 10m screws: less 25% • At 15m: Call for quote.



FOR ADDITIONAL INFORMATION LOG ON TO [WWW.TAMPERPROOF.COM](http://WWW.TAMPERPROOF.COM)

**TAMPERPROOF**  
SCREW CO., INC. OF NEW YORK



# TORX® SECURITY



## BUTTON HEAD/MACHINE SCREW

1 8 - 8 STAINLESS STEEL

DIAMETER	LENGTH	PART NO.	PRICE CODE	DRIVER SIZE
<b>4-40</b>	1/4	4.44014BS	B1	<b>T-8</b>
	3/8	4.44038BS	B1	
	1/2	4.44012BS	B1	
	3/4	4.44034BS	B1	

DIAMETER	LENGTH	PART NO.	PRICE CODE	DRIVER SIZE
<b>6-32</b>	1/4	4.63214BS	A9	<b>T-10</b>
	3/8	4.63238BS	A9	
	1/2	4.63212BS	A9	
	3/4	4.63234BS	A9	
	1	4.6321BS	A9	
	1-1/4	4.632114BS	C6	
	1-1/2	4.632112BS	C6	

DIAMETER	LENGTH	PART NO.	PRICE CODE	DRIVER SIZE
<b>8-32</b>	1/4	4.83214BS	A9	<b>T-15</b>
	3/8	4.83238BS	B1	
	1/2	4.83212BS	B3	
	3/4	4.83234BS	B4	
	1	4.8321BS	B5	
	1-1/4	4.832114BS	D1	
	1-1/2	4.832112BS	D1	

DIAMETER	LENGTH	PART NO.	PRICE CODE	DRIVER SIZE
<b>10-32</b>	3/8	4.10338BS	C1	<b>T-25</b>
	1/2	4.10312BS	C1	
	5/8	4.10358BS	C1	
	3/4	4.10334BS	C3	
	1	4.1031BS	C5	
	1-1/4	4.103114BS	D1	

DIAMETER	LENGTH	PART NO.	PRICE CODE	DRIVER SIZE
<b>10-24</b>	3/8	4.10238BS	C1	<b>T-25</b>
	1/2	4.10212BS	C1	
	5/8	4.10258BS	C1	
	3/4	4.10234BS	C3	
	1	4.1021BS	C5	
	1-1/4	4.102114BS	D1	

DIAMETER	LENGTH	PART NO.	PRICE CODE	DRIVER SIZE
<b>1/4-20</b>	1/2	4.14212BS	C6	<b>T-27</b>
	3/4	4.14234BS	C6	
	1	4.1421BS	D1	
	1-1/4	4.142114BS	D4	
	1-1/2	4.142112BS	D4	
	2	4.1422BS	E3	

DIAMETER	LENGTH	PART NO.	PRICE CODE	DRIVER SIZE
<b>1/4-28</b>	1/2	4.14812BS	D1	<b>T-27</b>
	3/4	4.14834BS	D1	
	1	4.1481BS	D4	

DIAMETER	LENGTH	PART NO.	PRICE CODE	DRIVER SIZE
<b>5/16-18</b>	3/4	4.51634BS	E1	<b>T-40</b>
	1	4.5161BS	E3	
	1-1/2	4.516112BS	E5	



## BUTTON HEAD/SHEET METAL SCREWS

TYPE A, 1 8 - 8 STAINLESS STEEL

DIAMETER	LENGTH	PART NO.	PRICE CODE	DRIVER SIZE
<b>#6</b>	1/2	4.6A12BS	B4	<b>T-10</b>
	3/4	4.6A34BS	B4	
	1	4.6A1BS	B4	

DIAMETER	LENGTH	PART NO.	PRICE CODE	DRIVER SIZE
<b>#8</b>	1/2	4.8A12BS	B7	<b>T-15</b>
	3/4	4.8A34BS	B7	
	1	4.8A1BS	B7	
	1-1/4	4.8A114BS	C3	
	1-1/2	4.8A112BS	C6	

DIAMETER	LENGTH	PART NO.	PRICE CODE	DRIVER SIZE
<b>#10</b>	1/2	4.10A12BS	B8	<b>T-25</b>
	3/4	4.10A34BS	B8	
	1	4.10A1BS	B8	
	1-1/4	4.10A114BS	C5	
	1-1/2	4.10A112BS	C6	

DIAMETER	LENGTH	PART NO.	PRICE CODE	DRIVER SIZE
<b>#12</b>	2*	4.12AB2BS	D7	<b>T-27</b>
	2-1/2*	4.12AB212BS	D8	
	3*	4.12AB3BS	E1	

DIAMETER	LENGTH	PART NO.	PRICE CODE	DRIVER SIZE
<b>#14</b>	5/8	4.14A58BS	C6	<b>T-27</b>
	1	4.14A1BS	D3	
	1-1/2	4.14A112BS	D5	

\* Sheet metal screws type AB



**ALL PRICES PER 100**

See pages 32 and 33 for matching tools.

**TAMPERPROOF**  
SCREW CO., INC. OF NEW YORK

TO ORDER CALL 516-931-1616 OR FAX 516-931-1654

Manufacturers of Snake Eyes®

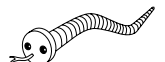



## FLAT HEAD/MACHINE SCREW

1 8 - 8 STAINLESS STEEL

DIAMETER	LENGTH	PART NO.	PRICE CODE	DRIVER SIZE
<b>4-40</b>	1/4	4.44014FS	B1	<b>T-8</b>
	3/8	4.44038FS	B1	
	1/2	4.44012FS	B1	

DIAMETER	LENGTH	PART NO.	PRICE CODE	DRIVER SIZE
<b>6-32</b>	3/8	4.63238FS	A9	<b>T-10</b>
	1/2	4.63212FS	A9	
	3/4	4.63234FS	A9	
	1	4.6321FS	A9	

DIAMETER	LENGTH	PART NO.	PRICE CODE	DRIVER SIZE
<b>8-32</b>	3/8	4.83238FS	B1	<b>T-15</b>
	1/2	4.83212FS	B4	
	3/4	4.83234FS	B4	
	1	4.8321FS	B5	

DIAMETER	LENGTH	PART NO.	PRICE CODE	DRIVER SIZE
<b>10-32</b>	1/2	4.10312FS	C1	<b>T-20</b>
	3/4	4.10334FS	C3	
	1	4.1031FS	C5	
	1-1/4	4.103114FS	D1	

DIAMETER	LENGTH	PART NO.	PRICE CODE	DRIVER SIZE
<b>10-24</b>	1/2	4.10212FS	C1	<b>T-20</b>
	3/4	4.10234FS	C3	
	1	4.1021FS	C5	
	1-1/4	4.102114FS	D1	

DIAMETER	LENGTH	PART NO.	PRICE CODE	DRIVER SIZE
<b>12-24</b>	1/2 UC	4.12212UFS	C3	

DIAMETER	LENGTH	PART NO.	PRICE CODE	DRIVER SIZE
<b>1/4-20</b>	1/2 UC	4.14212UFS	C6	<b>T-25</b>
	1/2	4.14212FS	C6	<b>T-27</b>
	3/4	4.14234FS	D1	
	1	4.1421FS	D1	
	1-1/4	4.142114FS	D4	
	1-1/2	4.142112FS	D4	

**Note:** "UC" denotes undercut head.



## FLAT HEAD/SHEET METAL SCREW

TYPE A, 1 8 - 8 STAINLESS STEEL

DIAMETER	LENGTH	PART NO.	PRICE CODE	DRIVER SIZE
<b>#6</b>	1/2	4.6A12FS	B4	<b>T-10</b>
	3/4	4.6A34FS	B4	
	1	4.6A1FS	B4	

DIAMETER	LENGTH	PART NO.	PRICE CODE	DRIVER SIZE
<b>#8</b>	1/2	4.8A12FS	B5	<b>T-15</b>
	3/4	4.8A34FS	B8	
	1	4.8A1FS	C1	
	1-1/4	4.8A114FS	C3	

DIAMETER	LENGTH	PART NO.	PRICE CODE	DRIVER SIZE
<b>#10</b>	3/4	4.10A34FS	C1	<b>T-20</b>
	1	4.10A1FS	C3	
	1-1/4	4.10A114FS	C6	
	1-1/2	4.10A112FS	C6	

DIAMETER	LENGTH	PART NO.	PRICE CODE	DRIVER SIZE
<b>#12</b>	2*	4.12AB2FS	D7	<b>T-25</b>
	2-1/2*	4.12AB212FS	D8	
	3*	4.12AB3FS	E1	

DIAMETER	LENGTH	PART NO.	PRICE CODE	DRIVER SIZE
<b>#14</b>	1	4.14A1FS	D3	<b>T-30</b>
	1-1/2	4.14A112FS	D5	

\* Sheet metal screws type AB



## SIX-LOBE SECURITY PAN HEAD SELF-DRILLING SHEET METAL SCREWS

TYPE AB, 4 10 STAINLESS STEEL

DIAMETER	LENGTH	PART NO.	PRICE CODE	DRIVER SIZE
<b>#8</b>	1/2	4.8ABK12PS	B8	<b>T-20</b>
	3/4	4.8ABK34PS	B8	
	1	4.8ABK1PS	C1	
	1-1/4	4.8ABK114PS	C6	

DIAMETER	LENGTH	PART NO.	PRICE CODE	DRIVER SIZE
<b>#10</b>	1/2	4.10ABK12PS	B9	<b>T-25</b>
	3/4	4.10ABK34PS	B9	
	1	4.10ABK1PS	C1	
	1-1/4	4.10ABK114PS	C6	
	1-1/2	4.10ABK112PS	C9	

### QUANTITY DISCOUNTS ON TORX® SECURITY SCREWS

(Per Size) At 1m screws: less 10% • At 5m screws: less 20% • At 10m screws: less 30% • At 25m screws: Call for quote. Note: Discount schedule doesn't apply to #12 SMS.







# PHILLIPS® SECURITY

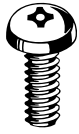

## PAN HEAD/MACHINE SCREW

1 8 - 8 STAINLESS STEEL

DIAMETER	LENGTH	PART NO.	PRICE CODE	DRIVER SIZE
<b>4-40</b>	1/4	2.44014PS	B4	<b>#1</b>
	3/8	2.44038PS	B4	
	1/2	2.44012PS	B4	

DIAMETER	LENGTH	PART NO.	PRICE CODE	DRIVER SIZE
<b>6-32</b>	1/4	2.63214PS	B5	<b>#1</b>
	3/8	2.63238PS	B5	
	1/2	2.63212PS	B5	
	3/4	2.63234PS	B5	
	1	2.6321PS	B5	<b>#2</b>
	1-1/4	2.632114PS	C7	
	1-1/2	2.632112PS	C8	
2	2.6322PS	C9		

DIAMETER	LENGTH	PART NO.	PRICE CODE	DRIVER SIZE
<b>8-32</b>	3/8	2.83238PS	C6	<b>#2</b>
	1/2	2.83212PS	C6	
	5/8	2.83258PS	C6	
	3/4	2.83234PS	C6	
	1	2.8321PS	C6	
	1-1/4	2.832114PS	C7	
	1-1/2	2.832112PS	C8	
	2	2.8322PS	C9	
	2-1/2	2.832212PS	D4	
	3	2.8323PS	D8	

DIAMETER	LENGTH	PART NO.	PRICE CODE	DRIVER SIZE
<b>10-32</b>	1/4	2.10314PS	C6	<b>#2</b>
	3/8	2.10338PS	C6	
	1/2	2.10312PS	C6	
	5/8	2.10358PS	C6	
	3/4	2.10334PS	C6	
	1	2.1031PS	C6	
	1-1/4	2.103114PS	C7	
	1-1/2	2.103112PS	C9	
	2	2.1032PS	D1	
	2-1/2	2.103212PS	D4	
	3	2.1033PS	D8	

DIAMETER	LENGTH	PART NO.	PRICE CODE	DRIVER SIZE
<b>10-24</b>	3/8	2.10238PS	C6	<b>#2</b>
	1/2	2.10212PS	C6	
	3/4	2.10234PS	C6	
	1	2.1021PS	C6	
	1-1/4	2.102114PS	C7	
	1-1/2	2.102112PS	C9	
	2	2.1022PS	D1	
	2-1/2	2.102212PS	D4	
	3	2.1023PS	D8	

DIAMETER	LENGTH	PART NO.	PRICE CODE	DRIVER SIZE
<b>12-24</b>	1/2	2.12212PS	C7	<b>#3</b>
	3/4	2.12234PS	C7	
	1	2.1221PS	C7	
	1-1/2	2.122112PS	D2	

DIAMETER	LENGTH	PART NO.	PRICE CODE	DRIVER SIZE
<b>1/4-20</b>	1/2	2.14212PS	D5	<b>#3</b>
	3/4	2.14234PS	D5	
	1	2.1421PS	D5	
	1-1/4	2.142114PS	D6	
	1-1/2	2.142112PS	D6	
	2	2.1422PS	D8	
	2-1/2	2.142212PS	E1	
	3	2.1423PS	E3	
	3-1/2	2.142312PS	E5	

DIAMETER	LENGTH	PART NO.	PRICE CODE	DRIVER SIZE
<b>1/4-28</b>	1/2	2.14812PS	D5	<b>#3</b>
	3/4	2.14834PS	D5	
	1	2.1481PS	D5	



**ALL PRICES PER 100**

See page 31 for matching tools.

**TAMPERPROOF**  
SCREW CO., INC. OF NEW YORK

TO ORDER CALL 516-931-1616 OR FAX 516-931-1654

Manufacturers of Snake Eyes®

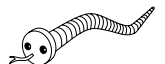



## FLAT HEAD/MACHINE SCREW

1 8 - 8 S T A I N L E S S S T E E L

DIAMETER	LENGTH	PART NO.	PRICE CODE	DRIVER SIZE
<b>4-40</b>	1/4	2.44014FS	B4	<b>#1</b>
	3/8	2.44038FS	B4	
	1/2	2.44012FS	B4	

DIAMETER	LENGTH	PART NO.	PRICE CODE	DRIVER SIZE
<b>6-32</b>	1/4	2.63214FS	B5	<b>#1</b>
	3/8	2.63238FS	B5	
	1/2	2.63212FS	B5	
	3/4	2.63234FS	B5	
	1	2.6321FS	B5	<b>#2</b>
	1-1/4	2.632114FS	C7	
	1-1/2	2.632112FS	C8	
	2	2.6322FS	C9	

DIAMETER	LENGTH	PART NO.	PRICE CODE	DRIVER SIZE
<b>8-32</b>	3/8	2.83238FS	C6	<b>#2</b>
	1/2	2.83212FS	C6	
	3/4	2.83234FS	C6	
	1	2.8321FS	C6	
	1-1/4	2.832114FS	C7	
	1-1/2	2.832112FS	C9	
	2	2.8322FS	D1	
	2-1/2	2.832212FS	D4	

DIAMETER	LENGTH	PART NO.	PRICE CODE	DRIVER SIZE
<b>10-32</b>	3/8	2.10338FS	C6	<b>#2</b>
	1/2	2.10312FS	C6	
	3/4	2.10334FS	C6	
	1	2.1031FS	C6	
	1-1/4	2.103114FS	C7	
	1-1/2	2.103112FS	C9	
	2	2.1032FS	D1	
	2-1/2	2.103212FS	D4	

DIAMETER	LENGTH	PART NO.	PRICE CODE	DRIVER SIZE
<b>10-24</b>	3/8	2.10238FS	C6	<b>#2</b>
	1/2	2.10212FS	C6	
	3/4	2.10234FS	C6	
	1	2.1021FS	C6	
	1-1/4	2.102114FS	C7	
	1-1/2	2.102112FS	C9	
	2	2.1022FS	D1	
	2-1/2	2.102212FS	D4	
	3	2.1023FS	D8	

DIAMETER	LENGTH	PART NO.	PRICE CODE	DRIVER SIZE
<b>12-24</b>	1/2	2.12212FS	C7	<b>#3</b>
	3/4	2.12234FS	C7	
	1	2.1221FS	C7	
	1-1/4	2.122114FS	C9	
	1-1/2	2.122112FS	D2	

DIAMETER	LENGTH	PART NO.	PRICE CODE	DRIVER SIZE
<b>1/4-20</b>	1/2	2.14212FS	D5	<b>#3</b>
	3/4	2.14234FS	D5	
	1	2.1421FS	D5	
	1-1/4	2.142114FS	D6	
	1-1/2	2.142112FS	D6	
	2	2.1422FS	D8	
	2-1/2	2.142212FS	E1	
	3	2.1423FS	E3	





# PHILLIPS® SECURITY



## PAN HEAD/SHEET METAL SCREWS

TYPE A, 18-8 STAINLESS STEEL

DIAMETER	LENGTH	PART NO.	PRICE CODE	DRIVER SIZE
<b>#4</b>	1/4*	2.4AB14PS	B4	<b>#1</b>
	3/8*	2.4AB38PS	B4	
	1/2*	2.4AB12PS	B4	

DIAMETER	LENGTH	PART NO.	PRICE CODE	DRIVER SIZE
<b>#6</b>	1/2*	2.6AB12PS	B5	<b>#1</b>
	3/4*	2.6AB34PS	B5	
	1*	2.6AB1PS	B5	
	1-1/4	2.6A114PS	C7	<b>#2</b>
	1-1/2	2.6A112PS	C8	
	2	2.6A2PS	C9	

DIAMETER	LENGTH	PART NO.	PRICE CODE	DRIVER SIZE
<b>#8</b>	3/8	2.8A38PS	C6	<b>#2</b>
	1/2	2.8A12PS	C6	
	3/4	2.8A34PS	C6	
	1	2.8A1PS	C6	
	1-1/4	2.8A114PS	C7	
	1-1/2	2.8A112PS	C8	
	2	2.8A2PS	C9	
	2-1/2	2.8A212PS	D4	
	3	2.8A3PS	D8	

DIAMETER	LENGTH	PART NO.	PRICE CODE	DRIVER SIZE
<b>#10</b>	1/2	2.10A12PS	C6	<b>#2</b>
	3/4	2.10A34PS	C6	
	1	2.10A1PS	C6	
	1-1/4	2.10A114PS	C7	
	1-1/2	2.10A112PS	C8	
	2	2.10A2PS	D1	
	2-1/2	2.10A212PS	D4	
	3	2.10A3PS	D8	
	3-1/2	2.10A312PS	E1	

\*Sheet Metal Screws Type AB.

DIAMETER	LENGTH	PART NO.	PRICE CODE	DRIVER SIZE
<b>#12</b>	1/2	2.12A12PS	C7	<b>#3</b>
	3/4	2.12A34PS	C7	
	1	2.12A1PS	C7	
	1-1/4	2.12A114PS	C9	
	1-1/2	2.12A112PS	D2	
	2	2.12A2PS	D2	
	2-1/2	2.12A212PS	D8	
	3	2.12A3PS	D8	

DIAMETER	LENGTH	PART NO.	PRICE CODE	DRIVER SIZE
<b>#14</b>	1/2	2.14A12PS	D5	<b>#3</b>
	3/4	2.14A34PS	D5	
	1	2.14A1PS	D5	
	1-1/4	2.14A114PS	D6	
	1-1/2	2.14A112PS	D6	
	2	2.14A2PS	D8	
	2-1/2	2.14A212PS	E1	
	3	2.14A3PS	E3	



**ALL PRICES PER 100**

See page 31 for matching tools.

**TAMPERPROOF**  
SCREW CO., INC. OF NEW YORK

TO ORDER CALL 516-931-1616 OR FAX 516-931-1654

Manufacturers of Snake Eyes®

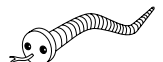



## FLAT HEAD/SHEET METAL SCREWS

TYPE A, 18-8 STAINLESS STEEL

DIAMETER	LENGTH	PART NO.	PRICE CODE	DRIVER SIZE
<b>#4</b>	1/2*	2.4AB12FS	B4	<b>#1</b>
	3/4*	2.4AB13FS	B4	
	1*	2.4AB1FS	B4	

DIAMETER	LENGTH	PART NO.	PRICE CODE	DRIVER SIZE
<b>#6</b>	1/2*	2.6AB12FS	B5	<b>#1</b>
	3/4*	2.6AB34FS	B5	
	1*	2.6AB1FS	B5	
	1-1/4	2.6A114FS	C7	<b>#2</b>
	1-1/2	2.6A112FS	C8	
	2	2.6A2FS	C9	

DIAMETER	LENGTH	PART NO.	PRICE CODE	DRIVER SIZE
<b>#8</b>	1/2	2.8A12FS	C6	<b>#2</b>
	3/4	2.8A34FS	C6	
	1	2.8A1FS	C6	
	1-1/4	2.8A114FS	C7	
	1-1/2	2.8A112FS	C8	
	2	2.8A2FS	C9	
	2-1/2	2.8A212FS	D4	
	3	2.8A3FS	D8	

DIAMETER	LENGTH	PART NO.	PRICE CODE	DRIVER SIZE
<b>#10</b>	1/2	2.10A12FS	C6	<b>#2</b>
	3/4	2.10A34FS	C6	
	1	2.10A1FS	C6	
	1-1/4	2.10A114FS	C7	
	1-1/2	2.10A112FS	C8	
	2	2.10A2FS	D1	
	2-1/2	2.10A212FS	D4	
	3	2.10A3FS	D8	

\*Sheet Metal Screws Type AB.

DIAMETER	LENGTH	PART NO.	PRICE CODE	DRIVER SIZE
<b>#12</b>	1/2	2.12A12FS	C7	<b>#3</b>
	3/4	2.12A34FS	C7	
	1	2.12A1FS	C7	
	1-1/4	2.12A114FS	C9	
	1-1/2	2.12A112FS	D2	
	2	2.12A2FS	D2	
	2-1/2	2.12A212FS	D8	
3	2.12A3FS	D8		

DIAMETER	LENGTH	PART NO.	PRICE CODE	DRIVER SIZE
<b>#14</b>	3/4	2.14A34FS	D5	<b>#3</b>
	1	2.14A1FS	D5	
	1-1/4	2.14A114FS	D6	
	1-1/2	2.14A112FS	D6	
	2	2.14A2FS	D8	
	2-1/2	2.14A212FS	E1	
	3	2.14A3FS	E3	





# ONE WAY



## ROUND HEAD/MACHINE SCREWS

1 8 - 8 S T A I N L E S S S T E E L

DIAMETER	LENGTH	PART NO.	PRICE CODE	DRIVER SIZE
4-40	1/4	5.44014RS	A2	No Matching Driver Needed
	5/16	5.440516RS	A2	
	3/8	5.44038RS	A2	
	1/2	5.44012RS	A2	
	3/4	5.44034RS	A2	
	1	5.4401RS	A3	

DIAMETER	LENGTH	PART NO.	PRICE CODE	DRIVER SIZE
6-32	3/16	5.632316RS	A2	No Matching Driver Needed
	1/4	5.63214RS	A2	
	3/8	5.63238RS	A2	
	1/2	5.63212RS	A2	
	3/4	5.63234RS	A3	
	1	5.6321RS	A4	

DIAMETER	LENGTH	PART NO.	PRICE CODE	DRIVER SIZE
8-32	1/4	5.83214RS	A3	No Matching Driver Needed
	3/8	5.83238RS	A3	
	1/2	5.83212RS	A4	
	3/4	5.83234RS	A4	
	1	5.8321RS	A4	
	1-1/4	5.832114RS	A5	
	1-1/2	5.832112RS	A7	

DIAMETER	LENGTH	PART NO.	PRICE CODE	DRIVER SIZE
10-32	3/8	5.10338RS	A4	No Matching Driver Needed
	1/2	5.10312RS	A4	
	5/8	5.10358RS	A5	
	3/4	5.10334RS	A5	
	1	5.1031RS	A6	
	1-1/4	5.103114RS	A7	
	1-1/2	5.103112RS	A9	
	2	5.1032RS	B4	

DIAMETER	LENGTH	PART NO.	PRICE CODE	DRIVER SIZE
10-24	1/4	5.10214RS	A4	No Matching Driver Needed
	3/8	5.10238RS	A4	
	1/2	5.10212RS	A4	
	5/8	5.10258RS	A5	
	3/4	5.10234RS	A5	
	1	5.1021RS	A6	
	1-1/4	5.102114RS	A7	
	1-1/2	5.102112RS	A9	
	2	5.1022RS	B4	

DIAMETER	LENGTH	PART NO.	PRICE CODE	DRIVER SIZE
1/4-20	1/2	5.14212RS	A9	No Matching Driver Needed
	5/8	5.14258RS	A9	
	3/4	5.14234RS	A9	
	7/8	5.14278RS	B4	
	1	5.1421RS	B5	
	1-1/4	5.142114RS	B8	
	1-1/2	5.142112RS	B8	
	2	5.1422RS	C5	

DIAMETER	LENGTH	PART NO.	PRICE CODE	DRIVER SIZE
5/16-18	3/4	5.51634RS	C3	No Matching Driver Needed
	1	5.5161RS	C6	
	1-1/2	5.516112RS	D1	
	2	5.5162RS	D4	

*ONE-WAYS are easily installed with a standard screwdriver. Removal may be possible with the "Un-Do-It" removal tools. See tools on page 33.*



## TRUSS HEAD/MACHINE SCREWS

1 8 - 8 S T A I N L E S S S T E E L

DIAMETER	LENGTH	PART NO.	PRICE CODE	DRIVER SIZE
10-32	1/4	5.10314TS	A4	No Matching Driver Needed
	3/8	5.10338TS	A5	
	1/2	5.10312TS	A6	
	3/4	5.10334TS	A7	

DIAMETER	LENGTH	PART NO.	PRICE CODE	DRIVER SIZE
*10-24	1/2	5.10212TS	A6	No Matching Driver Needed
	3/4	5.10234TS	A7	
	1	5.1021TS	A9	
	1-1/4	5.102114TS	B1	
	1-1/2	5.102112TS	B3	
	2	5.1022TS	B4	

\*Note: These screws may be used with the Female One-Way sex bolts. See page 24.



ALL PRICES PER 100

TAMPERPROOF  
SCREW CO., INC. OF NEW YORK

TO ORDER CALL 516-931-1616 OR FAX 516-931-1654

Manufacturers of Snake Eyes®

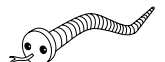



## ROUND HEAD/ SHEET METAL SCREWS

TYPE A, 18-8 STAINLESS STEEL

DIAMETER	LENGTH	PART NO.	PRICE CODE	DRIVER SIZE
#4	3/8	5.4A38RS	A1	No Matching Driver Needed
	1/2	5.4A12RS	A1	
	3/4	5.4A34RS	A2	

DIAMETER	LENGTH	PART NO.	PRICE CODE	DRIVER SIZE
#6	1/2	5.6A12RS	A2	No Matching Driver Needed
	3/4	5.6A34RS	A3	
	1	5.6A1RS	A4	
	1-1/4	5.6A114RS	A5	

DIAMETER	LENGTH	PART NO.	PRICE CODE	DRIVER SIZE
#8	1/2	5.8A12RS	A4	No Matching Driver Needed
	3/4	5.8A34RS	A4	
	1	5.8A1RS	A4	
	1-1/4	5.8A114RS	A5	
	1-1/2	5.8A112RS	A7	

DIAMETER	LENGTH	PART NO.	PRICE CODE	DRIVER SIZE
#10	1/2	5.10A12RS	A4	No Matching Driver Needed
	3/4	5.10A34RS	A6	
	1	5.10A1RS	A7	
	1-1/4	5.10A114RS	A7	
	1-1/2	5.10A112RS	A9	
	2	5.10A2RS	B4	

DIAMETER	LENGTH	PART NO.	PRICE CODE	DRIVER SIZE
#12	1/2*	5.12A12PS	A6	No Matching Driver Needed
	5/8*	5.12A58PS	A7	
	3/4*	5.12A34PS	A7	
	1*	5.12A1PS	A9	
	1-1/4*	5.12A114PS	B3	
	1-1/2*	5.12A112PS	B4	
	2*	5.12A2PS	B8	
	2-1/2	5.12A212RS	C9	

DIAMETER	LENGTH	PART NO.	PRICE CODE	DRIVER SIZE
#14	1/2	5.14A12RS	B1	No Matching Driver Needed
	3/4	5.14A34RS	B4	
	1	5.14A1RS	B8	
	1-1/4	5.14A114RS	C1	
	1-1/2	5.14A112RS	C1	
	2	5.14A2RS	C5	
	3	5.14A3RS	C9	

\*Available in Pan Head only.



## OVAL HEAD/COUNTERSUNK MACHINE SCREWS

18-8 STAINLESS STEEL

DIAMETER	LENGTH	PART NO.	PRICE CODE	DRIVER SIZE
6-32	1/2	5.63212OS	A2	No Matching Driver Needed
	3/4	5.63234OS	A3	
	1	5.6321OS	A4	

DIAMETER	LENGTH	PART NO.	PRICE CODE	DRIVER SIZE
8-32	1/2	5.83212OS	A3	No Matching Driver Needed
	3/4	5.83234OS	A4	
	1	5.8321OS	A5	

DIAMETER	LENGTH	PART NO.	PRICE CODE	DRIVER SIZE
10-32	1/2	5.10312OS	A4	No Matching Driver Needed
	3/4	5.10334OS	A5	
	1	5.1031OS	A6	

DIAMETER	LENGTH	PART NO.	PRICE CODE	DRIVER SIZE
10-24	1/2	5.10212OS	A4	No Matching Driver Needed
	3/4	5.10234OS	A5	
	1	5.1021OS	A6	

DIAMETER	LENGTH	PART NO.	PRICE CODE	DRIVER SIZE
1/4-20	1/2	5.14212OS	B1	No Matching Driver Needed
	1	5.1421OS	B8	
	1-1/2	5.142112OS	C1	

*ONE-WAYS are easily installed with a standard screwdriver. Removal may be possible with the "Un-Do-It" removal tools. See tools on page 33.*

### QUANTITY DISCOUNTS ON ONE-WAY SECURITY SCREWS

(Per Size) At 1m screws: less 10% • At 5m screws: less 20% • At 10m screws: less 30% • At 15m: Call for quote





# ONE WAY



## OVAL HEAD/COUNTERSUNK SHEET METAL SCREWS

TYPE A, 18-8 STAINLESS STEEL

DIAMETER	LENGTH	PART NO.	PRICE CODE	DRIVER SIZE
#8	1/2	5.8A12OS	A3	No Matching Driver Needed
	3/4	5.8A34OS	A4	
	1	5.8A1OS	A5	
	1-1/4	5.8A114OS	A7	
	1-1/2	5.8A112OS	A9	

DIAMETER	LENGTH	PART NO.	PRICE CODE	DRIVER SIZE
#10	1/2 UC	5.10A12UOS	A4	No Matching Driver Needed
	3/4	5.10A34OS	A5	
	1	5.10A1OS	A7	
	1-1/4	5.10A114OS	A7	
	1-1/2	5.10A112OS	A9	

Note: "UC" denotes undercut head.

# ONE WAY SEX BOLT



## ONE WAY SEX BOLTS

18-8 STAINLESS STEEL

One Way Sex Bolts are only available as 10-24 Truss Heads in 18-8 Stainless Steel only. They may be ordered as a complete set, consisting of a male and female part, and sized according to the **Total Partition Size**. Posts fit 1/4" diameter holes.

Or, these screws can be ordered **individually** as separate male and female parts.

See accompanying chart for dimension details.

To order by partition size: priced per set.  
Each set consisting of 2 screws (1 male, 1 female):

DIAMETER	LENGTH	PART NO.	PRICE CODE	DRIVER SIZE
10-24	3/4	5X.10234PS	E1	No Matching Driver Needed
	1	5X.1021PS	E3	
	1-1/4	5X.102114PS	E6	

To order individual male and female parts:

DIAMETER	LENGTH	PART NO.	PRICE CODE	DRIVER SIZE
10-24	1/2 Male	5X.10212MS	B7	No Matching Driver Needed
	3/4 Male	5X.10234MS	B7	
	1/2 Female	5X.10212FS	D1	
	3/4 Female	5X.10234FS	D4	
	1 Female	5X.1021FS	D8	

DIMENSIONS OF SETS				
M	+	F	=	P
1/2"	+	1/2"	=	3/4"
3/4"	+	3/4"	=	1"
3/4"	+	1"	=	1-1/4"

Note: M denotes male, F denotes female, P denotes partition size.

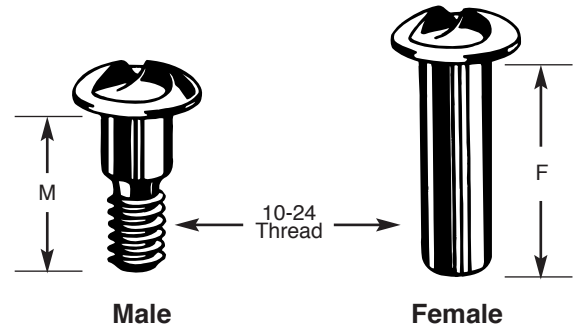

Male

Female

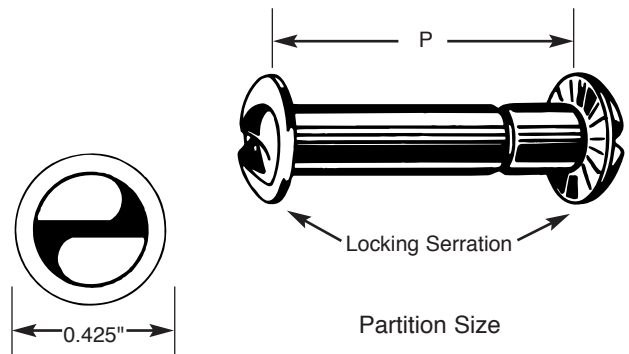

ONE-WAY Slotted Truss Head

Partition Size

Manufacturers of Snake Eyes®

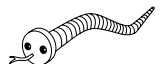

ALL PRICES PER 100

See page 33 for matching tools.

TAMPERPROOF SCREW CO., INC. OF NEW YORK

TO ORDER CALL 516-931-1616 OR FAX 516-931-1654



## PAN HEAD/SHEET METAL SCREWS

TYPE A, 18-8 STAINLESS STEEL

DIAMETER	LENGTH	PART NO.	PRICE CODE	DRIVER SIZE
#4	3/8*	3.4AB38PS	A4	W2
	1/2*	3.4AB12PS	A4	

DIAMETER	LENGTH	PART NO.	PRICE CODE	DRIVER SIZE
#6	1/2	3.6A12PS	A4	W3
	3/4	3.6A34PS	A4	
	1	3.6A1PS	A5	
	1-1/4	3.6A114PS	A6	
	1-1/2	3.6A112PS	A7	

DIAMETER	LENGTH	PART NO.	PRICE CODE	DRIVER SIZE
#8	1/2	3.8A12PS	A5	W4
	5/8*	3.8AB58PS	A5	
	3/4	3.8A34PS	A5	
	1	3.8A1PS	A6	
	1-1/4	3.8A114PS	A7	
	1-1/2	3.8A112PS	A9	

DIAMETER	LENGTH	PART NO.	PRICE CODE	DRIVER SIZE
#10	1/2	3.10A12PS	A6	W5
	3/4	3.10A34PS	A7	
	1	3.10A1PS	A8	

\*Sheet Metal Screws Type AB.



## PAN HEAD/MACHINE SCREWS

18-8 STAINLESS STEEL

DIAMETER	LENGTH	PART NO.	PRICE CODE	DRIVER SIZE
6-32	1/4	3.63214PS	A3	W3
	3/8	3.63238PS	A3	
	1/2	3.63212PS	A3	
	3/4	3.63234PS	A3	
	1	3.6321PS	A4	

DIAMETER	LENGTH	PART NO.	PRICE CODE	DRIVER SIZE
8-32	3/8	3.83238PS	A4	W4
	1/2	3.83212PS	A4	
	3/4	3.83234PS	A4	
	1	3.8321PS	A5	

DIAMETER	LENGTH	PART NO.	PRICE CODE	DRIVER SIZE
10-32	1/2	3.10312PS	A6	W5
	3/4	3.10334PS	A6	
	1	3.1031PS	A7	

DIAMETER	LENGTH	PART NO.	PRICE CODE	DRIVER SIZE
10-24	1/2	3.10212PS	A6	W5
	3/4	3.10234PS	A6	
	1	3.1021PS	A7	

## OPSIT®

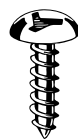

## TRUSS HEAD/SHEET METAL LEFT-HANDED THREAD SCREWS

TYPE A, 18-8 STAINLESS STEEL

DIAMETER	LENGTH	PART NO.	PRICE CODE	DRIVER SIZE
#8	1/2	3L.8A12TS	A6	W4
	3/4	3L.8A34TS	A7	
	1	3L.8A1TS	A9	
	1-1/4	3L.8A114TS	B3	
	1-1/2	3L.8A112TS	B4	

DIAMETER	LENGTH	PART NO.	PRICE CODE	DRIVER SIZE
#10	1/2	3L.10A12TS	A7	W5
	3/4	3L.10A34TS	A9	
	1	3L.10A1TS	B3	
	1-1/4	3L.10A114TS	B5	
	1-1/2	3L.10A112TS	B8	

## TP3® SCREWS

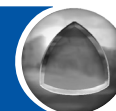

## TRIANGULAR RECESS SCREWS PAN HEAD/SHEET METAL SCREWS

TYPE A, 410 STAINLESS STEEL

DIAMETER	LENGTH	PART NO.	PRICE CODE	DRIVER SIZE
#8	1/2	8.8A12PS	A9	TL1
	3/4	8.8A34PS	A9	
	1	8.8A1PS	B3	
	1-1/4	8.8A114PS	B5	
	1-1/2	8.8A112PS	B8	

DIAMETER	LENGTH	PART NO.	PRICE CODE	DRIVER SIZE
#10	1/2	8.10A12PS	B4	TL1
	3/4	8.10A34PS	B8	
	1	8.10A1PS	C1	
	1-1/4	8.10A114PS	C2	
	1-1/2	8.10A112PS	C4	
	2	8.10A2PS	C6	

Manufacturers of **OPSIT**

**QUANTITY DISCOUNTS ON ONE-WAY, TRI-WING®, OPSIT® AND TP3 SECURITY SCREWS**

(Per Size) At 1m screws: less 10% • At 5m screws: less 20% • At 10m screws: less 30% • At 15m: Call for quote



FOR ADDITIONAL INFORMATION LOG ON TO [WWW.TAMPERPROOF.COM](http://WWW.TAMPERPROOF.COM)

**TAMPERPROOF**  
SCREW CO., INC. OF NEW YORK





# METRIC SNAKE EYES®



## PAN HEAD/MACHINE SCREWS

DIN 85, 18-8 STAINLESS STEEL

DIAMETER	LENGTH	PART NO.	PRICE CODE	DRIVER SIZE
<b>M3</b>	6	1.M36PS	B4	<b>4</b>
	8	1.M38PS	B4	
	10	1.M310PS	B4	
	12	1.M312PS	B4	
	16	1.M316PS	B4	
	20	1M320PS	B4	

DIAMETER	LENGTH	PART NO.	PRICE CODE	DRIVER SIZE
<b>M3.5</b>	6	1.M356PS	B6	<b>6</b>
	12	1.M3512PS	B6	

DIAMETER	LENGTH	PART NO.	PRICE CODE	DRIVER SIZE
<b>M4</b>	5	1.M45PS	B6	<b>8</b>
	6	1.M46PS	B6	
	10	1.M410PS	B6	
	12	1.M412PS	B6	
	16	1.M416PS	B6	
	20	1.M420PS	B6	
	25	1.M425PS	B6	

DIAMETER	LENGTH	PART NO.	PRICE CODE	DRIVER SIZE
<b>M5</b>	12	1.M512PS	B8	<b>10</b>
	16	1.M516PS	B8	
	20	1.M520PS	B8	
	25	1.M525PS	B8	
	30	1.M530PS	B8	

DIAMETER	LENGTH	PART NO.	PRICE CODE	DRIVER SIZE
<b>M6</b>	12	1.M612PS	C6	<b>1/4</b>
	14	1.M614PS	C6	
	16	1.M616PS	C6	
	20	1.M620PS	C6	
	25	1.M625PS	C6	
	30	1.M630PS	C8	
	40	1.M640PS	D1	

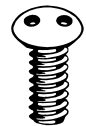

## OVAL HEAD/MACHINE SCREWS

DIN 964, 18-8 STAINLESS STEEL

DIAMETER	LENGTH	PART NO.	PRICE CODE	DRIVER SIZE
<b>M3.5</b>	10	1.M3510OS	B6	<b>6</b>
	12	1.M3512OS	B6	
	20	1.M3520OS	B6	
	25	1.M3525OS	B6	
	30	1.M3530OS	B6	
	50	1.M3550OS	C1	



## FLAT HEAD/MACHINE SCREWS

DIN 963, 18-8 STAINLESS STEEL

DIAMETER	LENGTH	PART NO.	PRICE CODE	DRIVER SIZE
<b>M3</b>	6	1.M36FS	B4	<b>4</b>
	8	1.M38FS	B4	
	10	1.M310FS	B4	
	12	1.M312FS	B4	
	16	1.M316FS	B4	
	25	1.M325FS	B8	
30	1.M330FS	B8		

DIAMETER	LENGTH	PART NO.	PRICE CODE	DRIVER SIZE
<b>M4</b>	8	1.M48FS	B6	<b>8</b>
	10	1.M410FS	B6	
	12	1.M412FS	B6	
	16	1.M416FS	B6	
	20	1.M420FS	B6	
	25	1.M425FS	B6	
	35	1.M435FS	B8	
50	1.M450FS	C1		

DIAMETER	LENGTH	PART NO.	PRICE CODE	DRIVER SIZE
<b>M5</b>	12	1.M512FS	B8	<b>10</b>
	16	1.M516FS	B8	
	20	1.M520FS	B8	
	25	1.M525FS	B8	
	30	1.M530FS	C1	
	35	1.M535FS	C6	

DIAMETER	LENGTH	PART NO.	PRICE CODE	DRIVER SIZE
<b>M6</b>	12	1.M612FS	C6	<b>1/4</b>
	16	1.M616FS	C6	
	20	1.M620FS	C6	
	25	1.M625FS	C6	
	30	1.M630FS	C8	
	40	1.M640FS	D1	

# METRIC PHILLIPS



## PHILLIPS PIN-HEAD SECURITY SCREWS

AVAILABLE UPON REQUEST

Sizes M3.5 Diameter to M6, in Pan Head (DIN 7985) and Flat Heads (DIN 65). Consult your salesperson.



Manufacturers of Snake Eyes®

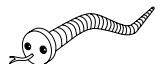

**ALL PRICES PER 100**

See page 29 for matching tools.

**TAMPERPROOF**  
SCREW CO., INC. OF NEW YORK

TO ORDER CALL 516-931-1616 OR FAX 516-931-1654



## METRIC CONVERSION

Any of our Sheet Metal Screws can be interchanged with a Metric equivalent. To determine size, consult the following chart.

DIAMETER (METRIC* TO AMERICAN)		
Metric 2.9	=	# 4 U.S. Standard
Metric 3.5	=	# 6 U.S. Standard
Metric 4.2	=	# 8 U.S. Standard
Metric 4.8	=	#10 U.S. Standard
Metric 5.5	=	#12 U.S. Standard
Metric 6.3	=	#14 U.S. Standard

LENGTHS (MILLIMETERS* TO INCHES)		
13 mm	=	1/2"
19 mm	=	3/4"
25 mm	=	1"
32 mm	=	1-1/4"
38 mm	=	1-1/2"
50 mm	=	2"
75 mm	=	3"

\*NOTE: Dimensions are approximate



## BUTTON HEAD/MACHINE SCREW

IFI STANDARDS  
1 8 - 8 STAINLESS STEEL

DIAMETER	LENGTH	PART NO.	PRICE CODE	DRIVER SIZE
<b>M3</b>	10	4.M310BS	C1	<b>T-10</b>
	12	4.M312BS	C1	
	16	4.M316BS	C1	

DIAMETER	LENGTH	PART NO.	PRICE CODE	DRIVER SIZE
<b>M4</b>	10	4.M410BS	B8	<b>T-15</b>
	12	4.M412BS	B8	
	16	4.M416BS	B8	
	20	4.M420BS	C1	
	25	4.M425BS	C3	

DIAMETER	LENGTH	PART NO.	PRICE CODE	DRIVER SIZE
<b>M5</b>	12	4.M512BS	C6	<b>T-25</b>
	16	4.M516BS	C6	
	20	4.M520BS	C8	
	25	4.M525BS	D1	
	30	4.M530BS	D3	

DIAMETER	LENGTH	PART NO.	PRICE CODE	DRIVER SIZE
<b>M6</b>	12	4.M612BS	D1	<b>T-27</b>
	16	4.M616BS	D1	
	20	4.M620BS	D1	
	25	4.M625BS	D5	
	30	4.M630BS	D8	
	40	4.M640BS	D9	



## FLAT HEAD/MACHINE SCREW

IFI STANDARDS  
1 8 - 8 STAINLESS STEEL

DIAMETER	LENGTH	PART NO.	PRICE CODE	DRIVER SIZE
<b>M3</b>	6	4.M36FS	B4	<b>T-10</b>
	8	4.M38FS	C1	
	10	4.M310FS	C1	
	12	4.M312FS	C1	
	16	4.M316FS	C1	

DIAMETER	LENGTH	PART NO.	PRICE CODE	DRIVER SIZE
<b>M3.5</b>	8	4.M358FS	C3	<b>T-15</b>
	10	4.M3510FS	C3	
	12	4.M3512FS	C3	
	20	4.M3520FS	C3	
	25	4.M3525FS	C3	
	30	4.M3530FS	C3	

DIAMETER	LENGTH	PART NO.	PRICE CODE	DRIVER SIZE
<b>M4</b>	8	4.M48FS	C8	<b>T-20</b>
	10	4.M410FS	C8	
	12	4.M412FS	C8	
	16	4.M416FS	C8	
	20	4.M420FS	C8	
	25	4.M425FS	C8	
	35	4.M435FS	C8	

DIAMETER	LENGTH	PART NO.	PRICE CODE	DRIVER SIZE
<b>M5</b>	12	4.M512FS	D2	<b>T-25</b>
	16	4.M516FS	D2	
	20	4.M520FS	D2	
	25	4.M525FS	D2	
	35	4.M535FS	D2	

DIAMETER	LENGTH	PART NO.	PRICE CODE	DRIVER SIZE
<b>M6</b>	12	4.M612FS	D9	<b>T-30</b>
	20	4.M620FS	D9	
	25	4.M625FS	D9	
	30	4.M630FS	D9	
	40	4.M640FS	D9	

**QUANTITY DISCOUNTS ON METRIC SNAKE EYES® AND METRIC TORX®**  
(Per Size) At 1m screws: less 10% • At 5m screws: less 20% • At 10m screws: less 30% • At 15m: Call for quote



FOR ADDITIONAL INFORMATION LOG ON TO [WWW.TAMPERPROOF.COM](http://WWW.TAMPERPROOF.COM)

**TAMPERPROOF**  
SCREW CO., INC. OF NEW YORK



# METRIC SOCKET SECURITY

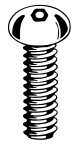

## BUTTON HEAD/CAP SCREWS

1 8 - 8 STAINLESS STEEL

DIAMETER	LENGTH	PART NO.	PRICE CODE	DRIVER SIZE
<b>M3</b>	6	6.M36BS	A9	<b>M2</b>
	10	6.M310BS	A9	
	16	6.M316BS	A9	

DIAMETER	LENGTH	PART NO.	PRICE CODE	DRIVER SIZE
<b>M4</b>	10	6.M410BS	B8	<b>M25</b>
	12	6.M412BS	B8	
	16	6.M416BS	B8	
	20	6.M420BS	B8	
	25	6.M425BS	B8	

DIAMETER	LENGTH	PART NO.	PRICE CODE	DRIVER SIZE
<b>M5</b>	12	6.M512BS	B8	<b>M3</b>
	16	6.M516BS	B8	
	20	6.M520BS	C1	
	25	6.M525BS	C2	
	30	6.M530BS	C6	

DIAMETER	LENGTH	PART NO.	PRICE CODE	DRIVER SIZE
<b>M6</b>	12	6.M612BS	B8	<b>5/32"</b>
	16	6.M616BS	C2	
	20	6.M620BS	C5	
	40	6.M640BS	D1	



## FLAT HEAD/CAP SCREW

1 8 - 8 STAINLESS STEEL

DIAMETER	LENGTH	PART NO.	PRICE CODE	DRIVER SIZE
<b>M3</b>	8	6.M38FS	B4	<b>M2</b>
	10	6.M310FS	B4	

DIAMETER	LENGTH	PART NO.	PRICE CODE	DRIVER SIZE
<b>M4</b>	10	6.M410FS	B8	<b>M25</b>
	12	6.M412FS	B8	
	16	6.M416FS	B8	
	20	6.M420FS	B8	
	25	6.M425FS	B8	

DIAMETER	LENGTH	PART NO.	PRICE CODE	DRIVER SIZE
<b>M5</b>	12	6.M512FS	C6	<b>M3</b>
	16	6.M516FS	C6	
	20	6.M520FS	C6	
	25	6.M525FS	C6	
	30	6.M530FS	C6	

DIAMETER	LENGTH	PART NO.	PRICE CODE	DRIVER SIZE
<b>M6</b>	16	6.M616FS	D1	<b>5/32"</b>
	20	6.M620FS	D1	
	25	6.M625FS	D1	
	30	6.M630FS	D1	
	40	6.M640FS	D1	

# STANDARD TORX®



## STANDARD TORX® NON-SECURITY PAN HEAD/SHEET METAL SCREWS

TYPE AB, 1 8 - 8 STAINLESS STEEL

DIAMETER	LENGTH	PART NO.	PRICE CODE	DRIVER SIZE
<b>#8</b>	1/2	7.8AB12PS	A8	<b>T-20</b>
	3/4	7.8AB34PS	A9	
	1	7.8A1PS	B2	
	1-1/4	7.8A114PS	B7	

DIAMETER	LENGTH	PART NO.	PRICE CODE	DRIVER SIZE
<b>#10</b>	1/2	7.10AB12PS	B1	<b>T-25</b>
	3/4	7.10AB34PS	B4	
	1	7.10AB1PS	B6	
	1-1/4	7.10AB114PS	C2	
	1-1/2	7.10AB112PS	C3	



**ALL PRICES PER 100**

See pages 30 and 33 for matching tools.

**TAMPERPROOF**  
SCREW CO., INC. OF NEW YORK

TO ORDER CALL 516-931-1616 OR FAX 516-931-1654

Manufacturers of Snake Eyes®

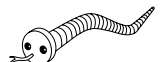

# TOOLS AND KITS

## SPANNERS

### BITS ONLY

SIZE	DIAMETER	PART NO.	PRICE CODE
#4 Bit	(1/4" Hex)	1B.414	S2
#4 Bit	(5/16" Hex)	1B.4516	S2
#6 Bit	(1/4" Hex)	1B.614	S2
#6 Bit	(5/16" Hex)	1B.6516	S2
#8 Bit	(1/4" Hex)	1B.814	S2
#8 Bit	(5/16" Hex)	1B.8516	S2
#10 Bit	(1/4" Hex)	1B.1014	S2
#10 Bit	(5/16" Hex)	1B.10516	S2
#12 Bit	(1/4" Hex)	1B.1214	S2
#12 Bit	(5/16" Hex)	1B.12516	S2
#1/4 Bit	(1/4" Hex)	1B.1414	S2
#1/4 Bit	(5/16" Hex)	1B.14516	S2

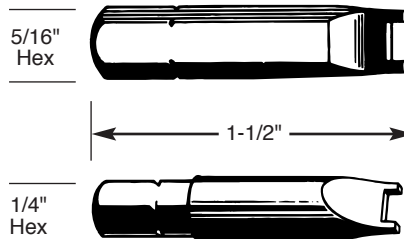

SPANNER BITS  
Indicate size/hex shank when ordering

### DRIVERS COMPLETE-HANDLE WITH BIT

SIZE	PART NO.	PRICE CODE
#4 Driver	1D.4	S8
#6 Driver	1D.6	S8
#8 Driver	1D.8	S8
#10 Driver	1D.10	S8
#12 Driver	1D.12	S8
#1/4 Driver	1D.14	S8

SPANNER DRIVER COMPLETE  
Indicate size when ordering

### SPANNER DRIVER KIT #SP5

SIZE	PART NO.	PRICE CODE
#SP5 Driver Kit w/ 5 Bits (1/4" Hex)	SP5.14	T5
#SP5 Driver Kit w/ 5 Bits (5/16" Hex)	SP5.516	T5

1 Magnetic Hand Driver with 5 Spanner Bits  
(Spanner Sizes 6, 8, 10, 12, 1/4) in a convenient vinyl pouch.

### SPANNER DRIVER KIT #SP6

SIZE	PART NO.	PRICE CODE
#SP6 Driver Kit w/ 6 Bits (1/4" Hex)	SP6.14	T6
#SP6 Driver Kit w/ 6 Bits (5/16" Hex)	SP6.516	T6

1 Magnetic Hand Driver with 6 Spanner Bits  
(Spanner Sizes 4, 6, 8, 10, 12, 1/4) in a convenient vinyl pouch.

## MAGNETIC HAND DRIVERS

### FOR INTERCHANGEABLE BITS WITH STORAGE COMPARTMENTS

SIZE	PART NO.	PRICE CODE
1/4" Hex-Drive	MAG14	S9
5/16" Hex-Drive	MAG516	S9

**Note:** Tamper-Resistant Tools are NOT guaranteed against overtorque, misuse, breakage or wear and are not refundable.

MAGNETIC HAND DRIVER  
Order bits separately

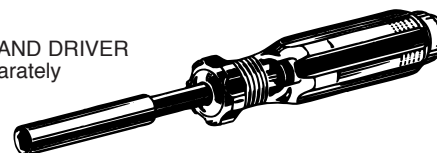

### QUANTITY DISCOUNTS ON TOOLS AND KITS

Call for details.



**TAMPERPROOF**  
SCREW CO., INC. OF NEW YORK

FOR ADDITIONAL INFORMATION LOG ON TO [WWW.TAMPERPROOF.COM](http://WWW.TAMPERPROOF.COM)

# TOOLS AND KITS

## TRI-WING®

### BITS ONLY

SIZE	DIAMETER	PART NO.	PRICE CODE
W1 Bit Only	(1/4" Hex)	3B.W1	S3
W2 Bit Only	(1/4" Hex)	3B.W2	S3
W3 Bit Only	(1/4" Hex)	3B.W3	S3
W4 Bit Only	(1/4" Hex)	3B.W4	S3
W5 Bit Only	(1/4" Hex)	3B.W5	S3



TRI-WING® BITS  
Indicate size when ordering

### DRIVERS COMPLETE-HANDLE WITH BIT

SIZE	PART NO.	PRICE CODE
W1 Driver	3D.W1	S8
W2 Driver	3D.W2	S8
W3 Driver	3D.W3	S8
W4 Driver	3D.W4	S8
W5 Driver	3D.W5	S8

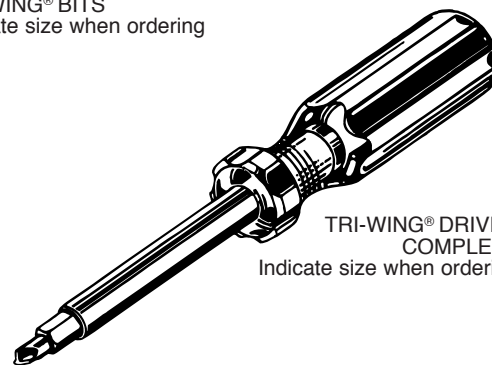

TRI-WING® DRIVER  
COMPLETE  
Indicate size when ordering

## SOCKET PIN-HEAD

### BITS ONLY

SIZE	DIAMETER	PART NO.	PRICE CODE
3/32" Bit	(1/4" Hex)	6B.332	S3
1/8" Bit	(1/4" Hex)	6B.18	S3
5/32" Bit	(1/4" Hex)	6B.532	S3
3/16" Bit	(1/4" Hex)	6B.316	S3
7/32" Bit	(1/4" Hex)	6B.732	S3
2mm Bit	(1/4" Hex)	6B.M2	S2
2.5mm Bit	(1/4" Hex)	6B.M25	S2
3mm Bit	(1/4" Hex)	6B.M3	S2
4mm Bit	(1/4" Hex)	6B.M4	S2



SOCKET PIN-HEAD BITS  
Indicate size when ordering

### KEYS

SIZE	PART NO.	PRICE CODE
3/32" Key (Double-Ended)	6K.332	S3
1/8" Key (Double-Ended)	6K.18	S3
5/32" Key (Double-Ended)	6K.532	S3
3/16" Key (Double-Ended)	6K.316	S3
7/32" Key (Double-Ended)	6K.732	S3
1/4" Key (Single-Ended)	6K.14	S4
5/16" Key (Single-Ended)	6K.516	S5
3/8" Key (Single-Ended)	6K.38	S6
2mm Key (Double-Ended)	6K.M2	S3
2.5mm Key (Double-Ended)	6K.M25	S3
3mm Key (Double-Ended)	6K.M3	S3

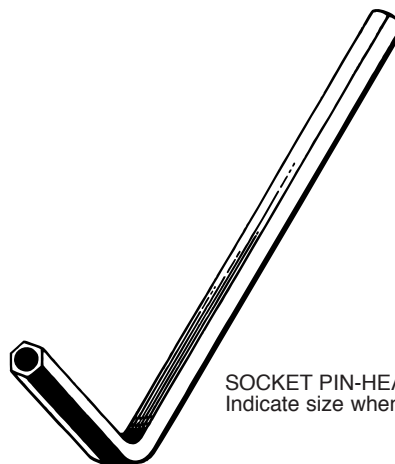

SOCKET PIN-HEAD KEYS  
Indicate size when ordering



**TAMPERPROOF**  
SCREW CO., INC. OF NEW YORK

TO ORDER CALL 516-931-1616 OR FAX 516-931-1654

Manufacturers of Snake Eyes®

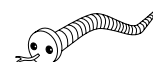

# TOOLS AND KITS

## SOCKET PIN-HEAD

### DRIVERS COMPLETE-HANDLE WITH BIT

SIZE	PART NO.	PRICE CODE
3/32" Driver	6D.332	S8
1/8" Driver	6D.18	S8
5/32" Driver	6D.532	S8
3/16" Driver	6D.316	S8
7/32" Driver	6D.732	S8

### HEX KEY KIT #HX4 AND HX5

SIZE	PART NO.	PRICE CODE
#HX4 Kit with 4 Keys	HX4	T1
#HX5 Kit with 5 Keys	HX5	T3

#HX4 (Sizes 1/8", 5/32", 3/16", 7/32") in a vinyl pouch.

#HX5 (Sizes 3/32", 1/8", 5/32", 3/16", 7/32") in a vinyl pouch.

### HEX BIT KIT #HX4B AND HX5B

SIZE	PART NO.	PRICE CODE
#HX4B Kit w/ 4 Bits (1/4" Hex)	HX4B	T1
#HX5B Kit w/ 5 Bits (1/4" Hex)	HX5B	T3

#HX4B (Sizes 1/8", 5/32", 3/16", 7/32") in a vinyl pouch.

#HX5B (Sizes 3/32", 1/8", 5/32", 3/16", 7/32") in a vinyl pouch.

### HEX BIT KIT #HX5DB

SIZE	PART NO.	PRICE CODE
#HX5DB Driver Kit W/ 5 Bits	HX5DB	T5

1 Magnetic Hand Driver with 5 Hex Bits

(Sizes 3/32", 1/8", 5/32", 3/16", 7/32") in a vinyl pouch.

## PHILLIPS PIN-HEAD

### BITS ONLY

SIZE	PART NO.	PRICE CODE
#1 Bit Only (1/4" Hex)	2B.1	S3
#2 Bit Only (1/4" Hex)	2B.2	S3
#3 Bit Only (1/4" Hex)	2B.3	S3

### DRIVERS COMPLETE-HANDLE WITH BIT

SIZE	PART NO.	PRICE CODE
#1 Driver Complete	2D.1	S8
#2 Driver Complete	2D.2	S8
#3 Driver Complete	2D.3	S8

**Note:** Tamper-Resistant Tools are NOT guaranteed against overtorque, misuse, breakage or wear and are not refundable.

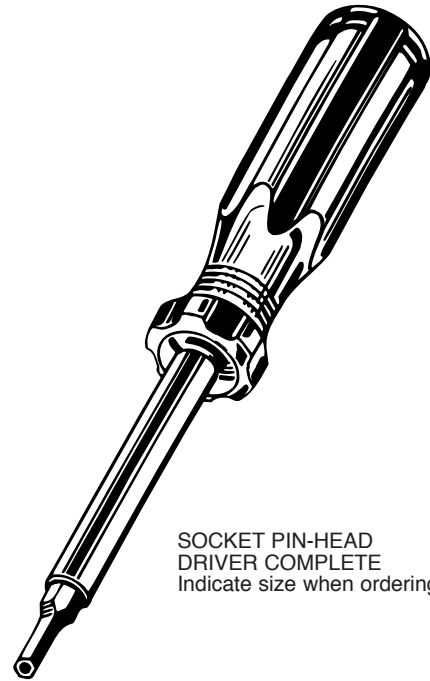

SOCKET PIN-HEAD  
DRIVER COMPLETE  
Indicate size when ordering



PHILLIPS PIN-HEAD BITS  
Indicate size when ordering

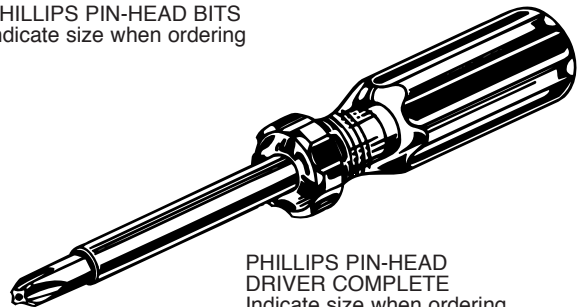

PHILLIPS PIN-HEAD  
DRIVER COMPLETE  
Indicate size when ordering

**QUANTITY DISCOUNTS ON TOOLS AND KITS**

Call for details.



**TAMPERPROOF**  
SCREW CO., INC. OF NEW YORK

FOR ADDITIONAL INFORMATION LOG ON TO [WWW.TAMPERPROOF.COM](http://WWW.TAMPERPROOF.COM)

# TOOLS AND KITS

## TORX® TAMPERPROOF

### BITS ONLY

SIZE	PART NO.	PRICE CODE
T-7 Bit (1/4" Hex)	4B.T7	S3
T-8 Bit (1/4" Hex)	4B.T8	S3
T-9 Bit (1/4" Hex)	4B.T9	S3
T-10 Bit (1/4" Hex)	4B.T10	S3
T-15 Bit (1/4" Hex)	4B.T15	S3
T-20 Bit (1/4" Hex)	4B.T20	S3
T-25 Bit (1/4" Hex)	4B.T25	S3
T-27 Bit (1/4" Hex)	4B.T27	S3
T-30 Bit (1/4" Hex)	4B.T30	S3
T-40 Bit (1/4" Hex)	4B.T40	S3
T-45 Bit (5/16" Hex)	4B.T45	S5
T-50 Bit (5/16" Hex)	4B.T50	S6

### KEYS-BOTH ENDS DRILLED

SIZE		PART NO.	PRICE CODE
T-7	(Double-Ended)	4K.T7	S8
T-8	(Double-Ended)	4K.T8	S8
T-9	(Double-Ended)	4K.T9	S8
T-10	(Double-Ended)	4K.T10	S4
T-15	(Double-Ended)	4K.T15	S4
T-20	(Double-Ended)	4K.T20	S4
T-25	(Double-Ended)	4K.T25	S4
T-27	(Double-Ended)	4K.T27	S5
T-30	(Double-Ended)	4K.T30	S5
T-40	(Double-Ended)	4K.T40	S7
T-45	(Double-Ended)	4K.T45	S8

### DRIVERS COMPLETE-HANDLE WITH BIT

SIZE	PART NO.	PRICE CODE
T-7 Driver	4D.T7	S8
T-8 Driver	4D.T8	S8
T-9 Driver	4D.T9	S8
T-10 Driver	4D.T10	S8
T-15 Driver	4D.T15	S8
T-20 Driver	4D.T20	S8
T-25 Driver	4D.T25	S8
T-27 Driver	4D.T27	S8
T-30 Driver	4D.T30	S8
T-40 Driver	4D.T40	S8
T-45 Driver	4D.T45	S9
T-50 Driver	4D.T50	T1



TORX® TAMPERPROOF BIT  
Indicate size when ordering

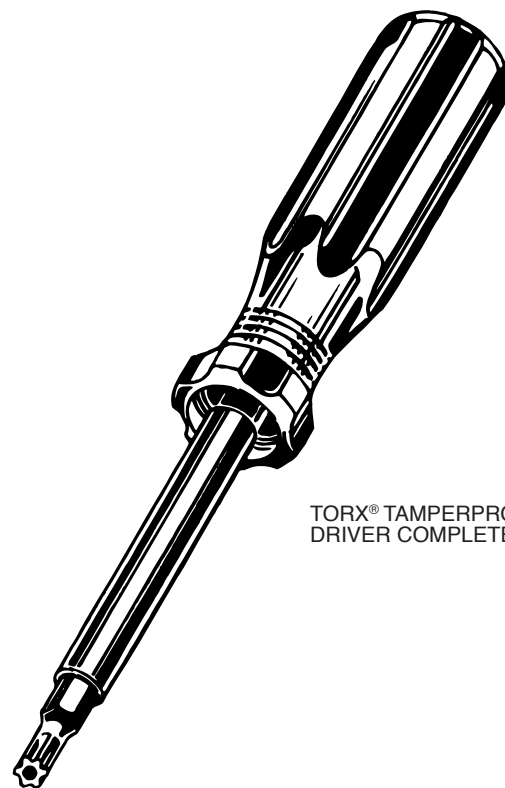

TORX® TAMPERPROOF  
DRIVER COMPLETE



**TAMPERPROOF**  
SCREW CO., INC. OF NEW YORK

TO ORDER CALL 516-931-1616 OR FAX 516-931-1654

Manufacturers of Snake Eyes®

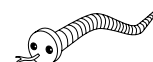

# TOOLS AND KITS

## TORX BIT KIT #TX7B AND TX9B

SIZE	PART NO.	PRICE CODE
#TX7B Kit With 7 Bits (1/4" Hex)	TX7B	T4
#TX9B Kit With 9 Bits (1/4" Hex)	TX7B	T7

#TX7B (Sizes T8, T9, T10, T15, T20, T25, T27) in a vinyl pouch.  
 #TX9B (Sizes T8, T9, T10, T15, T20, T25, T27, T30, T40) in a vinyl pouch.

## TORX KEY KIT #TX5K

SIZE	PART NO.	PRICE CODE
#TX5K Kit With 5 Keys		TX5K

T4  
 Keys (Double-Ended) in sizes T10, T15, T20, T25, T27 in a vinyl pouch.

## DRIVER KIT #TX7

SIZE	PART NO.	PRICE CODE
#TX7 Driver Kit With 7 Bits	TX7	T8

1 Magnetic Hand Driver with 7 Torx® Tamperproof Bits (Sizes T8, T9, T10, T15, T20, T25, T27) in a vinyl pouch.

## DRIVER KIT #TX9

SIZE	PART NO.	PRICE CODE
#TX9 Driver Kit With 9 Bits	TX9	T9

1 Magnetic Hand Driver with 9 Torx® Tamperproof Bits (Sizes T8, T9, T10, T15, T20, T25, T27, T30, T40) in a vinyl pouch.

## STANDARD TORX (NON-TAMPERPROOF)

STANDARD BITS ONLY	PART NO.	PRICE CODE
T-20 1/4" Hex	7B.T20	S1
T-25 1/4" Hex	7B.T25	S1

## TP3®

### TRIANGULAR RECESS SCREWS

	PART NO.	PRICE CODE
TL-1 Bit (1/4" Hex)	8B.TL1	S2
TL-1 Driver Complete	8D.TL1	S8



UN-DO-IT® REMOVAL TOOL

## ONE-WAYS

### "UN-DO-IT" REMOVAL TOOLS

SIZE	PART NO.	PRICE CODE
#804 (Screw Sizes 6-8)	5.804	T4
#807 (Screw Sizes 10-12)	5.807	T4
#810 (Screw Sizes 1/4)	5.810	T4

ONE-WAYS are easily installed with a standard screwdriver. Removal may be possible with the "Un-Do-It" removal tools.

QUANTITY DISCOUNTS ON TOOLS AND KITS

Call for details



FOR ADDITIONAL INFORMATION LOG ON TO [WWW.TAMPERPROOF.COM](http://WWW.TAMPERPROOF.COM)

**TAMPERPROOF**  
 SCREW CO., INC. OF NEW YORK



# TOOLS AND KITS

## COMPLETE TOOL KIT

#TSDK30

PART NO.	PRICE CODE
TSDK36	U1

Contains 35 assorted security bits plus 1 magnetic hand driver in a convenient plastic carrying case. Includes:

- Spanner Bits, #4, #6, #8, #10, #12, #1/4.
- Torx® Tamperproof Bits, T7, T8, T9, T10, T15, T20, T25, T27, T30, T40.
- Phillips Pin-Head Bits, #1, #2, #3.
- Socket Pin-Head Bits, 3/32", 1/8", 5/32", 7/32", 3/16", 2mm, 2.5mm, 3mm, 4mm.
- Tri-Wing® Bits, W3, W4, W5.
- Square Drive Bits, R1, R2.
- 1 Spanner Nut Bit.
- 1 TP3 Triangular Recess Bit #TL1

All Bits and Driver in 1/4" Hex.

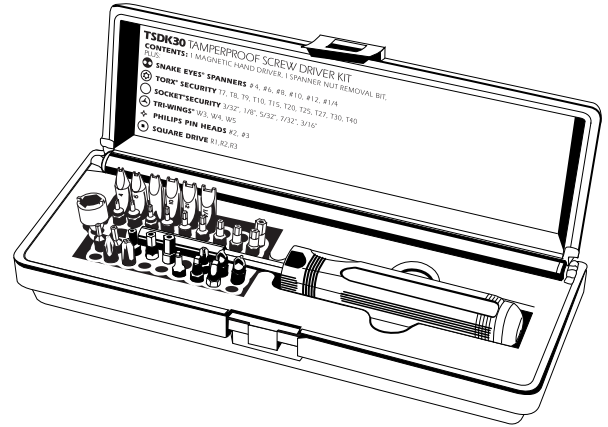

## SPANNER SCREW KIT

#1000

PART NO.	PRICE CODE
1.1000	U2

Contains 20 most-wanted sizes of machine and wood/metal Snake Eyes® Spanner security screws. A total of 1,000 screws in stainless steel. Sizes 6, 8 and 10 in lengths from 1/2" to 1". Flat Heads and Pan Heads. Includes 3 special matching drivers. All in a sturdy steel storage box. Ideal for schools, prisons, museums, hospitals and other institutions.

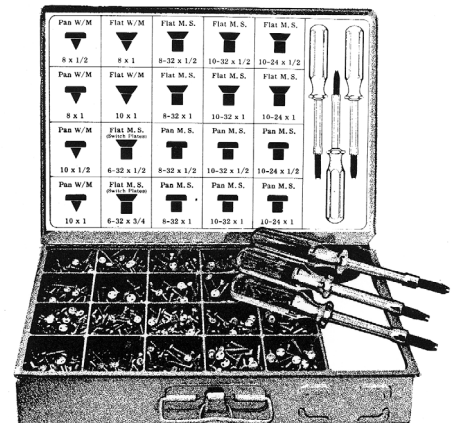

## TORX® SECURITY SCREW KIT

#1000

PART NO.	PRICE CODE
4.1000	U2

Contains 20 popular sizes of machine and wood/metal Torx® security screws. A total of 1,000 screws in stainless steel. Sizes 6, 8 and 10 in lengths from 1/2" to 1". Flat Heads and Button Heads. Includes four matching driver bits and magnetic hand driver. All in a sturdy steel storage box.

**Note:** Tamper-Resistant Tools are NOT guaranteed against overtorque, misuse, breakage or wear and are not refundable.



**QUANTITY DISCOUNTS ON TOOLS AND KITS**  
Call for details

**TAMPERPROOF**  
SCREW CO., INC. OF NEW YORK

TO ORDER CALL 516-931-1616 OR FAX 516-931-1654

Manufacturers of Snake Eyes®





**TAMPERPROOF  
SCREW CO., INC.**

**TEL 516.931.1616 • FAX 516.931.1654**

30 Laurel Street • Hicksville, New York 11801 • [www.tamperproof.com](http://www.tamperproof.com)

Prices and discounts effective May 1, 2006 subject to change without notice. ©2006 Tamperproof Screw Company, Inc.