

SIMPSON

Strong-Tie

®

2016–2017 Product Guide

Anchoring and
Fastening Systems



(800) 999-5099 | www.strongtie.com

Anchor Product Selection Guide









Product	Page No.	Tested Base Materials and Code Listings						Other Listings	
		Concrete		Concrete on Metal Deck	CMU		Unreinforced Clay Brick Masonry		Other
		Cracked	Uncracked		Grout-Filled	Hollow			
AT-XP®	12	ER-263, RR25960, FL-16230.1	—	—	ER-281, RR25966, FL-16230.1	—	—	NSF/ANSI Std 61, DOT	
SET-XP®	14	ESR-2508, RR25744, FL-17449.2	—	—	ER-265, RR25965, FL-16230.3	ER-265	—	NSF/ANSI Std 61, DOT	
ET-HP®	16	ESR-3372, FL-17449.1	—	—	ER-241, FL-16230.2	—	—	DOT	
AT	18	—	Non-IBC	—	Non-IBC	Non-IBC	—	DOT	
SET	20	—	Non-IBC	—	Non-IBC	Non-IBC	ESR-1772, FL-15730.5	NSF/ANSI Std 61, DOT	
EDOT	22	—	Non-IBC	—	—	—	—	DOT	

Adhesive Anchors

Anchor Product Selection Guide

Mechanical Anchors						
Torq-Cut™		38	ESR-2705, RR25946, FL-15731.3	—	—	—
Strong-Bolt® 2		41	ESR-3037, RR25691, FL-15731.2	ESR-3037, RR25691, FL-15731.2	ER-240, RR25936, FL-16230.4	UL, FM, DOT
Wedge-All®		43	—	Non-IBC	ESR-1396, FL-15730.7	UL, FM, DOT
Easy-Set		49	—	Non-IBC	—	—
Sleeve-All®		50	—	Non-IBC	Non-IBC	UL, FM, DOT
Titen HD®		52	ESR-2713, RR25741, FL-15730.6	ESR-2713, RR25741, FL-15730.6	ESR-1056, RR25660, FL-15730.6	FM, DOT
Titen®		56	—	FL-2355.1	FL-2355.1	—



Anchor Product Selection Guide

Product	Page No.	Tested Base Materials and Code Listings								Other Listings
		Concrete		Concrete on Metal Deck	CMU		Unreinforced Clay Brick Masonry	Other		
		Cracked	Uncracked		Grout-Filled	Hollow				
 Titan HD® Rod Hanger	61	ESR-2713, RR25741, FL-15730.6	ESR-2713 RR25741	—	—	—	—	—	FM	
  Wood Rod Hanger	62	—	—	—	—	—	IBC (Wood)	UL, FM		
 Blue Banger Hanger®	63	ESR-3707	ESR-3707	—	—	—	IBC (Steel Roof Deck)	UL, FM		
  Drop-In (DIAB)	66	—	Non-IBC	—	—	—	—	UL, FM		
 Drop-In (DIA)	70	—	Non-IBC	—	—	—	Non-IBC (Hollow Core Panel)	UL, FM, DOT		
  Hollow Drop-In	73	—	Non-IBC	—	IBC	—	—	UL, FM		
Mechanical Anchors										

Anchor Product Selection Guide

—	—	—	FM	—	—	—
—	—	—	—	—	—	Drywall
—	—	—	—	—	—	—
—	—	—	—	—	—	—
—	—	—	—	—	—	—
—	—	—	Non-IBC	—	Non-IBC	—
Non-IBC	Non-IBC	Non-IBC	Non-IBC	Non-IBC	Non-IBC	—
—	—	—	—	—	—	—
77	75	76	78	80	48	81
						
Zinc Nation™	Lag Screw Expansion Shield	Expansion Screw Anchor	 Crimp Drive®	Split-Drive	Tie-Wire	Sure Wall
Mechanical Anchors						

Anchor Product Selection Guide

Product	Page No.	Tested Base Materials and Code Listings						Other Listings	
		Concrete		Concrete on Metal Deck	CMU		Unreinforced Clay Brick Masonry		Other
		Cracked	Uncracked		Grout-Filled	Hollow			
 Powder-Actuated Fasteners	112	—	ESR-2138, RR25469, FL-15730.3, FL-15730.4	ESR-2138, RR25469, FL-15730.3, FL-15730.4	ESR-2138, RR25469, FL-15730.3, FL-15730.4	—	Steel ESR-2138, RR25469, FL-15730.3, FL-15730.4	FM	
		—	ESR-2811, RR25837, FL-15730.1, FL-15730.2	ESR-2811, RR25837, FL-15730.1, FL-15730.2	ESR-2811, RR25837, FL-15730.1, FL-15730.2	—	Steel ESR-2811, RR25837, FL-15730.1, FL-15730.2		
 Gas-Actuated Fasteners	86	—	ESR-2811, RR25837, FL-15730.1, FL-15730.2	ESR-2811, RR25837, FL-15730.1, FL-15730.2	ESR-2811, RR25837, FL-15730.1, FL-15730.2	—	Steel ESR-2811, RR25837, FL-15730.1, FL-15730.2	—	

Direct Fastening

ESR or ER – ICC-ES or IAPMO UES code report available.
 RR – City of Los Angeles research report available.
 FL – Florida building code approval available.
 IBC – Load data is available in this catalog intended for use under IBC, but code listings are not available.

Non-IBC – Load data is available in this catalog, but it is outside the scope of the current IBC. May be permitted for non-IBC applications.
 UL – Underwriters Laboratories listing available.
 FM – Factory Mutual listing available.
 DOT – Various departments of transportation listings available. See www.strongtie.com/DOT for details.





Consult the code listings for more detailed information on which models of each product are covered by the listing.

Table of Contents

Adhesive Anchors

Adhesive Accessories	24
Adhesive Anchoring Installation Instructions.....	182
Adhesive Retaining Caps	28
Adhesive Shear Tubes.....	32
AT Acrylic Adhesive.....	18
AT-XP® Acrylic Adhesive.....	12
EDOT Adhesive.....	22
ET-HP® Adhesive	16
Hole-Cleaning Brushes	32
Opti-Mesh Adhesive Anchoring Screen Tubes	30
 Piston Plug Adhesive Delivery System.....	27
Retrofit Bolt	33
SET Epoxy Adhesive.....	20
SET-XP® Epoxy Adhesive.....	14
Steel Adhesive Anchoring Screen Tubes	29
Speed Clean™ Dust Extraction System	34



Mechanical Anchors

Blue Banger Hanger® Threaded Insert	63
 Crimp Drive® Anchor.....	78
 Drop-In Internally Threaded Anchor (DIAB).....	66
Drop-In Internally Threaded Anchor (DIA)	70
Easy-Set Pin-Drive Anchor.....	49
Expansion Screw Anchor	76
 Hollow Drop-In Anchor.....	73
LSES Lag Screw Expansion Shield	75
Sleeve-All® Sleeve Anchor.....	50
Split-Drive Anchor	80
Strong-Bolt® 2 Wedge Anchor	41
Sure Wall Drywall Anchor	81
 Tie-Wire Wedge Anchor	48
Titen HD® Screw Anchor.....	52
Titen® Screw	56
Titen® Stainless-Steel Screw	58
Titen HD® Rod Hanger.....	61
Titen HD® Rod Coupler.....	55
Torq-Cut™ Self-Undercutting Anchor.....	38
Wedge-All® Wedge Anchor.....	43
 Wood Rod Hanger	62
Zinc Nailon™ Pin Drive Anchor.....	77

New products are shown with the  symbol.

Table of Contents

Direct Fastening

Extension Tools	90
Gas-Actuated Fasteners and Accessories	86
GCN-MEP Concrete Nailer	84
Powder-Actuated Fasteners.....	112
Powder-Actuated Tool/Load/Fastener Matrix	91
Powder-Actuated Tool Matrix	92
Powder Loads.....	110
PTP-27L / PTP-27LMAGR.....	94
PTP-27S / PTP-27SMAGR.....	98
 PT-27HDA.....	102
PT-27	104
 PT-22A.....	106
PT-22HA	108
PT-22P.....	109

Restoration Solutions

Crack Injection Guide.....	214
Crack-Pac® Flex-H ₂ O™	128
Crack-Pac® Injection Epoxy	126
Crack Repair Accessories	130
Epoxy Injection Guide.....	221
ETI Injection Epoxy.....	124
 Heli-Tie™ Helical Stitching Tie	134
Heli-Tie™ Helical Wall Tie	132

Carbide Drill Bits and Accessories

“A” Taper Drill Bits	149
Core Bits	156
Demolition Bits	153
Rebar Cutter	151
Rebar Cutter Adaptors.....	152
SDS-MAX® Drill Bits	147
SDS-PLUS® Drill Bits.....	143
Spline/Straight Shank Drill Bits.....	148

Appendix

Acceptable Hole Diameter	225
Adhesive Anchoring Installation Instructions.....	182
Anchoring and Fastening Applications by Market.....	160
Crack Injection	214
Glossary of Terms	228
Length Identification Head Marks.....	223
Mechanical Anchoring Installation Instructions	190

Simpson Strong-Tie Company Inc.

**The Simpson Strong-Tie Company Inc.
“No Equal” pledge includes:**

- Quality products value-engineered for the lowest installed cost at the highest-rated performance levels
- Most thoroughly tested and evaluated products in the industry
- Strategically located manufacturing and warehouse facilities
- National code agency listings
- Largest number of patented connectors in the industry
- Global locations with an international sales team
- In-house R&D and tool-and-die professionals
- In-house product testing and quality-control engineers
- Support of industry groups including AISI, AITC, ASTM, ASCE, AWC, AWPA, ACI, AISC, CSI, CFSEI, ICFA, NBMDA, NLBMDA, SDI, SETMA, SFA, SFIA, STAFDA, SREA, NFBA, TPI, WDSC, WIJMA, WTCA and local engineering groups.

The Simpson Strong-Tie Quality Policy

We help people build safer structures economically. We do this by designing, engineering and manufacturing “No Equal” structural connectors and other related products that meet or exceed our customers’ needs and expectations. Everyone is responsible for product quality and is committed to ensuring the effectiveness of the Quality Management System.



Karen Colonias
Chief Executive Officer

We Are ISO 9001-2008 Registered



Simpson Strong-Tie is an ISO 9001-2008 registered company. ISO 9001-2008 is an internationally recognized quality assurance system that lets our domestic and international customers know they can count on the consistent quality of Simpson Strong-Tie® products and services.

800-999-5099 | www.strongtie.com

All Rights Reserved. This guide may not be reproduced in whole or in part without the prior written approval of Simpson Strong-Tie Company Inc.

Product Identification Key

Products and additional information are divided into general categories, identified by tabs along the page’s outer edge.

Adhesive Anchors

10–35 ▶

Mechanical Anchors

36–81 ▶

Direct Fastening

82–121 ▶

Restoration Solutions

122–136 ▶

Carbide Drill Bits

138–157 ▶

Appendix

158–227 ▶

Glossary of Terms

228–231 ▶

Alphabetical Index of Products

232–235 ▶

Adhesive Anchors



SIMPSON**Strong-Tie**[®]

From rebar doweling on a high-traffic infrastructure retrofit project to do-it-yourself projects, Simpson Strong-Tie offers a wide variety of adhesive anchoring products to meet virtually any need.

Our strong, versatile epoxy-based adhesives are ideal for anchoring threaded rod, rebar and smooth dowels in an assortment of base materials. And our acrylic formulations deliver consistent performance for high-strength anchor grouting in a wide range of weather conditions — curing fast even in water-saturated concrete.

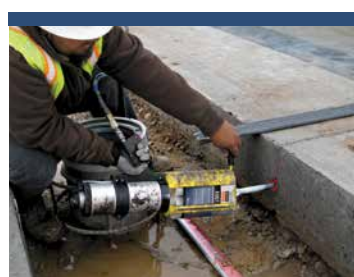

AT-XP® High-Strength Acrylic Adhesive

Formulated for high-strength anchorage of threaded rod and rebar into cracked and uncracked concrete and masonry under a wide range of conditions, AT-XP® adhesive dispenses easily in cold or warm environments and in below-freezing temperatures with no need to warm the cartridge. When mixed properly, this low-odor formula is a dark teal color for easy post-installation identification.

Features

- Passed the demanding ICC-ES AC308 adverse-condition tests pertaining to reduced and elevated temperatures and long-term sustained loads
- Code listed under the IBC/IRC for cracked and uncracked concrete per IAPMO UES ER-263 and City of L.A. RR25960
- Code listed under the IBC/IRC for masonry per IAPMO UES ER-281 and City of L.A. RR25966
- 10:1 two-component high-strength, acrylic-based anchoring adhesive
- Suitable for use under static and seismic loading conditions in cracked and uncracked concrete as well as masonry
- Easy hole-cleaning procedure – no power-brushing required
- Suitable for use in dry or water-saturated concrete
- For best results, store between 14°F and 80°F
- Cures in substrate temperatures as low as 14°F (-10°C) in 24 hours or less
- Available in 9.4 oz., 12.5 oz. and 30 oz. cartridges for application versatility
- Volatile Organic Compound (VOC) – 30 g/L
- Manufactured in the USA using global materials

Applications

- Threaded rod anchoring and rebar doweling into concrete and masonry
- Suitable for horizontal, vertical and overhead applications

Codes: IAPMO UES ER-263 (concrete); IAPMO UES ER-281 (masonry); City of L.A. RR25960 (concrete), RR25966 (masonry); FL-16230.1; NSF/ANSI Standard 61 (43.2 in.²/1,000 gal.)

Installation and Application Instructions

See pages 182-189.

AT-XP Adhesive Cartridge Systems

Model No.	Capacity (ounces)	Carton Quantity
AT-XP10	9.4	6
AT-XP13	12.5	10
AT-XP30	30	5



AT-XP® Adhesive

Cure Schedule

Base Material Temperature		Cure Time (hours)
°F	°C	
14	-10	24
32	0	8
50	10	3
68	20	1
86	30	30 min.
100	38	20 min.

For water-saturated concrete (including damp and water-filled holes), the cure times must be doubled.

Complementary Products



AT-XP10 Adhesive
9.4 oz. Cartridge



- **AMN19Q** – Adhesive mixing nozzle (page 26) (1 included)



- **CDT10S** – Manual dispensing tool for 9.4 oz. cartridges (page 24)



AT-XP13 Adhesive
12.5 oz. Cartridge



- **AMN19Q** – Adhesive mixing nozzle (page 26) (1 included)



- **ADT813S** – Manual dispensing tool for 13 oz. cartridges (page 25)



AT-XP30 Adhesive
30 oz. Cartridge



- **AMN19Q** – Adhesive mixing nozzle (page 26) (1 included)



- **ADT30S** – Manual dispensing tool for 30 oz. cartridges (page 25)



- **ADTA30P** – Pneumatic dispensing tool for 30 oz. acrylic adhesive dispensing cartridges (page 25)

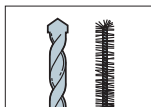

Other complementary products for installation of this product:
Drill Bits:
pages 140–157
Adhesive Accessories:
pages 24–34

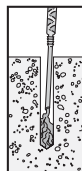

Installation instructions:
pages 182–189

SET-XP® High-Strength Acrylic Adhesive

SET-XP® epoxy anchoring adhesive is a high-strength formula for anchoring and doweling in cracked and uncracked concrete and masonry applications. It is a two-part system with the resin and hardener being simultaneously dispensed and mixed through the mixing nozzle. When properly mixed, adhesive will be a uniform teal color for easy post-installation identification.

Features

- 1:1 two-component, high-solids, epoxy-based anchoring adhesive formula
- Passed the demanding ICC-ES AC308 adverse-condition tests pertaining to elevated temperatures and long-term sustained loads
- Code listed under the IBC/IRC for cracked and uncracked concrete per ICC-ES ESR-2508
- Code listed under the IBC/IRC for masonry per IAPMO UES ER-265
- Suitable for use under static and seismic loading conditions in cracked and uncracked concrete and masonry
- Cure times: 24 hours at 70°F, 72 hours at 50°F
- Easy hole-cleaning – no power-brushing required
- Suitable for use in dry or water-saturated concrete
- For best results, store between 45°F and 90°F
- Available in 8.5 oz., 22 oz. and 56 oz. cartridges for application versatility
- Manufactured in the USA using global materials

Applications

- Threaded rod anchoring and rebar doweling into concrete and masonry
- Suitable for horizontal, vertical and overhead applications
- Multiple DOT listings – refer to www.strongtie.com/DOT for current approvals

Codes: ICC-ES ESR-2508 (concrete); IAPMO UES ER-265 (masonry); City of L.A. RR25744 (concrete), RR25965 (masonry); Florida FL-17449.2 (concrete), FL-16230.3 (masonry); AASHTO M-235 and ASTM C881 (Type I and IV, Grade 3, Class C); NSF/ANSI Standard 61 (216 in.²/1,000 gal.)

Installation and Application Instructions

See pages 182–189.

SET-XP Cartridge System

Model No.	Capacity (ounces)	Carton Quantity
SET-XP10	8.5	12
SET-XP22-N	22	10
SET-XP56	56	6



SET-XP® Adhesive

Cure Schedule

Base Material Temperature		Cure Time (hours)
°F	°C	
50	10	72
60	16	48
70	21	24
90	32	24
110	43	24

For water-saturated concrete (including damp and water-filled holes), the cure times must be doubled.

SET-XP® High-Strength Acrylic Adhesive

Complementary Products



SET-XP10 Adhesive
8.5 oz. Cartridge



- Epoxy adhesive mixing nozzle (2 included)



- **CDT10S** – Manual dispensing tool for 8.5 oz. cartridges (page 24)



SET-XP22 Adhesive
22 oz. Cartridge



- **EMN22i** – Epoxy adhesive mixing nozzle (1 included)



- **EDT22S** – Manual dispensing tool for 22 oz. cartridges (page 24)



- **EDTA22CKT** – Battery-powered dispensing tool for 22 oz. cartridges (page 24)



- **EDTA22P** – Pneumatic dispensing tool for 22 oz. cartridges (page 24)



SET-XP56 Adhesive
56 oz. Cartridge



- **EMN22i** – Epoxy adhesive mixing nozzle (page 26)



- **EDTA56P** – Pneumatic dispensing tool for 56 oz. cartridges (page 24)

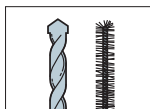

Other complementary products for installation of this product:
Drill Bits: pages 140–157
Adhesive Accessories: pages 24–34

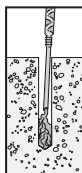

Installation instructions: pages 182–189

ET-HP® Epoxy Adhesive

ET-HP® is a two-component, high-solids, epoxy-based system for use as a high-strength, non-shrink anchor-grouting material. Resin and hardener are dispensed and mixed simultaneously through the mixing nozzle. ET-HP® is formulated for anchoring threaded rod and rebar into concrete (cracked/uncracked) and masonry.

Features

- Passed the demanding ICC-ES AC308 adverse-condition tests pertaining to elevated temperatures and long-term sustained loads
- Code listed under the IBC/IRC for cracked and uncracked concrete per ICC-ES ESR-3372
- Code listed under the IBC/IRC for masonry per IAPMO UES ER-241
- Suitable for use under static and seismic loading conditions in cracked and uncracked concrete and masonry
- Cure times: 24 hours at 80°F, 72 hours at 50°F
- Easy hole-cleaning – no power-brushing required
- Suitable for use in dry or water-saturated concrete
- When properly mixed, adhesive will be a uniform gray color
- Available in 22 oz. and 56 oz. cartridges for application versatility
- Manufactured in the USA using global materials

Applications

- Threaded rod anchoring and rebar doweling into concrete and unreinforced masonry
- Suitable for horizontal, vertical and overhead applications
- Multiple DOT listings – refer to www.strongtie.com/DOT for current approvals

Codes: ICC-ES ESR-3372 (concrete); ICC-ES ESR-3638 (unreinforced masonry); IAPMO UES ER-241 (masonry); City of L.A. RR25120 (unreinforced masonry); AASHTO M-235 and ASTM C881 (Type IV, Grade 3, Class C); multiple DOT listings; FL-17449.1; FL-16230.2.

Installation and Application Instructions

See pages 182–189.

ET-HP Cartridge Systems

Model No.	Capacity (ounces)	Carton Quantity
ET-HP22	22	10
ET-HP56	56	6



ET-HP® Adhesive

Cure Schedule

Base Material Temperature		Cure Time (hours)
°F	°C	
50	10	72
60	16	24
80	27	24
100	38	24

For water-saturated concrete (including damp and water-filled holes), the cure times must be doubled.

Complementary Products



ET-HP22 Adhesive
22 oz. Cartridge



ET-HP56 Adhesive
56 oz. Cartridge



- EMN22i – Epoxy adhesive mixing nozzle (page 26)



- EMN22i – Standard epoxy adhesive mixing nozzle (page 26)



- EDT22S – Manual dispensing tool for 22 oz. cartridges (page 24)



- EDTA56P – Pneumatic dispensing tool for 56 oz. cartridges (page 24)



- EDTA22CKT – Battery-powered dispensing tool for 22 oz. cartridges (page 24)



- EDTA22P – Pneumatic dispensing tool for 22 oz. cartridges (page 24)

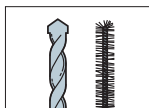

Other complementary products for installation of this product:
Drill Bits:
pages 140–157
Adhesive Accessories:
pages 24–34

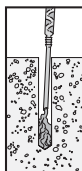

Installation instructions:
pages 182–189

AT Acrylic Adhesive

AT is a high-strength, acrylic-based adhesive anchoring system, formulated for use as a high-strength anchor-grouting material in a wide range of temperature conditions. It is a two-part system, with the resin and initiator being simultaneously dispensed and mixed through the mixing nozzle.

Features

- Code listed under the IBC/IRC for URM per ICC-ES ESR-1958
- Cure times – 24 hours at 0°F, 1 hour at 60°F
- Non-sag gel formulation ideal for horizontal, vertical and overhead applications
- Easy hole-cleaning procedure – no power-brushing required
- Suitable for use in damp or wet anchor sites
- When properly mixed, adhesive will be a uniform gray color
- Available in 9.6 oz., 12.5 oz. and 30 oz. cartridges for application versatility
- Manufactured in the USA using global materials

Applications

- Threaded rod anchoring and rebar doweling into concrete, masonry and URM (red brick)
- Multiple DOT listings – refer to www.strongtie.com/DOT for current approvals

Codes: ICC-ES ESR-1958 (URM); AASHTO M-235 and ASTM C881 (Type I and IV, Grade 3, Class A, B and C – except AT adhesive is a non-epoxy formulated for fast cure time); multiple DOT listings (refer to [strongtie.com/DOT](http://www.strongtie.com/DOT)).

Installation and Application Instructions

See pages 182–189.

AT Adhesive Cartridge Systems

Model No.	Capacity (ounces)	Carton Quantity
AT10	9.6	12
AT13	12.5	10
AT30	30	5



AT Adhesive

Cure Schedule

Base Material Temperature		Cure Time (hours)
°F	°C	
0	-18	24
25	-4	8
40	4	4
60	16	1
70	21	30 min.
100	38	20 min.

For water-saturated concrete (including damp and water-filled holes), the cure times must be doubled.

Complementary Products



AT13 Adhesive
12.5 oz. Cartridge



- **AMN19Q** – Adhesive mixing nozzle (page 26) (1 included)



- **ADT813S** – Manual dispensing tool for 12.5 oz. cartridges (page 25)



AT30 Adhesive
30 oz. Cartridge



- **AMN19Q** – Adhesive mixing nozzle (page 26) (1 included)



- **ADT30S** – Manual dispensing tool for 30 oz. cartridges (page 25)



- **ADTA30P** – Pneumatic dispensing tool for 30 oz. acrylic adhesive dispensing cartridges (page 25)

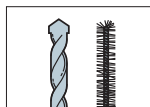

Other complementary products for installation of this product:

Drill Bits:
pages 140–157
Adhesive Accessories:
pages 24–34

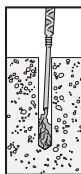

Installation instructions:
pages 182–189

SET Epoxy Adhesive

SET is a high-strength, non-shrink, epoxy-based adhesive formulated for anchoring and doweling threaded rod and rebar. Resin and hardener are dispensed and mixed simultaneously through the mixing nozzle.

Features

- Code listed under the IBC/IRC for URM per ICC-ES ESR-1772
- Meets or exceeds the requirements of ASTM C881 specification for Type I and IV, Grade 3, Class C
- Cure times – 24 hours at 65°F, 72 hours at 40°F
- Easy hole-cleaning procedure – no power-brushing required
- Suitable for use in damp or wet anchor sites
- When properly mixed, adhesive will be a uniform gray color
- Available in 22 oz. and 56 oz. cartridges for application versatility
- Manufactured in the USA using global materials

Applications

- Threaded rod anchoring and rebar doweling into concrete, masonry and URM (red brick)
- Pick-proof sealant around doors, windows and fixtures
- Paste-over for crack injection preparation
- Bonding hardened concrete to hardened concrete
- CalTrans and multiple DOT listings; refer to www.strongtie.com/DOT

Codes: ICC-ES ESR-1772 (unreinforced masonry); Florida FL15730.5; AASHTO M-235 and ASTM C881 (Type I and IV, Grade 3, Class C); CalTrans Approved; Multiple DOT listings; NSF/ANSI Standard 61 (216 in.²/1,000 gal.)

Installation and Application Instructions

See pages 182–189.

SET Cartridge System

Model No.	Capacity (ounces)	Carton Quantity
SET1.7KTA	1.7	12
SET22	22	10
SET56	56	6



SET Adhesive

Cure Schedule

Base Material Temperature		Cure Time (hours)
°F	°C	
40	4	72
65	18	24
85	29	20
90	32	16

For water-saturated concrete (including damp and water-filled holes), the cure times must be doubled.

Complementary Products



SET22 Adhesive
22 oz. Cartridge



- EMN22i – Epoxy adhesive mixing nozzle (page 26)



- EDT22S – Manual dispensing tool for 22 oz. cartridges (page 24)



- EDTA22CKT – Battery-powered dispensing tool for 22 oz. cartridges (page 24)



- EDTA22P – Pneumatic dispensing tool for 22 oz. cartridges (page 24)



SET56 Adhesive
56 oz. Cartridge



- EMN50 – High-flow epoxy adhesive mixing nozzle (page 26)



- EMN22i – Epoxy adhesive mixing nozzle (page 26)



- EDTA56P – Pneumatic dispensing tool for 56 oz. cartridges (page 24)



Other complementary products for installation of this product:

Drill Bits:

pages 140–157

Adhesive Accessories:

pages 24–34

Installation instructions:

pages

182–189

EDOT Epoxy Adhesive

Formulated specifically for transportation projects, EDOT adhesive is a two-component, high-solids epoxy system. It is designed for use as a high-strength, non-shrink anchor-grouting material. EDOT adhesive provides an economical solution for transportation applications. Visit www.strongtie.com/DOT for specific state DOT approvals.

Features

- Meets ASTM C881 and AASHTO M-235 specifications for Type I, II, IV and V, Grade 3, Class C
- Cure times – 24 hours at 60°F, 72 hours at 40°F
- Easy hole-cleaning procedure – no power-brushing required
- Suitable for use in damp or wet anchor sites
- When properly mixed, adhesive will be a uniform tan color
- Available in 22 oz. and 56 oz. cartridges for application versatility
- Available in 1-, 10- and 100-gallon bulk kits
- Made in the USA using global materials

Applications

- Threaded rod anchoring and rebar doweling into concrete and masonry
- Multiple DOT listings – refer to www.strongtie.com/DOT for current approvals

Codes: Multiple DOT listings (refer to www.strongtie.com/DOT for current approvals)

Installation and Application Instructions

See pages 182–189.



EDOT Adhesive

Cure Schedule

Base Material Temperature		Cure Time (hours)
°F	°C	
40	4	72
60	16	24
80	27	24
100	38	24

EDOT Package Systems

Model No.	Capacity	Carton Quantity
EDOT22	22 ounces	10
EDOT56	56 ounces	6
EDOT1KT	1-gallon kit	1 kit
EDOT10KT	10-gallon kit	1 kit
EDOT100KT	100-gallon kit	1 kit

Pot Life for 1 Gallon Mixed

Adhesive Temperature		Pot Life Time (min.)
°F	°C	
60	16	60
70	21	35
80	27	25
90	32	15
100	38	10

Complementary Products



EDOT22 Adhesive
22 oz. Cartridge



EDOT56 Adhesive
56 oz. Cartridge



EDOT1KT
1-Gallon Kit



- EMN22i – Epoxy adhesive mixing nozzle (page 26)



- EMN50 – High-flow epoxy adhesive mixing nozzle (page 26)



- EDT22S – Manual dispensing tool for 22 oz. cartridges (page 24)



- EMN22i – Standard epoxy adhesive mixing nozzle (page 26)



EDOT10KT
10-Gallon Kit



- EDTA22CKT – Battery-powered dispensing tool for 22 oz. cartridges (page 24)



- EDTA56P – Pneumatic dispensing tool for 56 oz. cartridges (page 24)



- For bulk applications, use the EMN37A bulk mixing nozzle

A 100-gallon kit (EDOT100KT) is also available. Contact Simpson Strong-Tie for more information.



- EDTA22P – Pneumatic dispensing tool for 22 oz. cartridges (page 24)



Other complementary products for installation of this product:
 Drill Bits: pages 140–157
 Adhesive Accessories: pages 24–34



Installation instructions: pages 182–189

Adhesive Accessories

Adhesive Dispensing Tools

Our heavy-duty tools are designed to work with our cartridges for trouble-free dispensing. Each manual tool provides a 26:1 drive mechanism for easier dispensing of high-viscosity adhesive.

CDT10S

Manual Dispensing Tool for Single Cartridge Adhesives

The CDT10S features a steel carriage for ultimate durability and is engineered for continuous, high-volume use, as well as double-gripping plates that help extend tool life.



CDT10S

EDT22S

Manual Dispensing Tool for 22 oz. Adhesive Cartridges

The EDT22S epoxy adhesive tool features a steel carriage and is engineered for high-volume, continuous use. The tool can be easily converted (conversion parts included) from dispensing a 22 oz., 1:1 ratio cartridge to a 16.5 oz., 2:1 ratio cartridge.



EDT22S

EDTA22CKT

Battery-Powered Dispensing Tool for 22 oz. Cartridges

The EDTA22C offers power dispensing of 22 oz., 1:1 ratio, dual-cartridge adhesives without the need for a hose or compressor. The 18V lithium-ion battery is 50% lighter than NiCad and offers 40% longer run time and 30-minute recharging. Tool converts to dispense 16.5 oz., 2:1 ratio dual-cartridge adhesives (conversion parts included). The EDTA22CKT comes with the dispensing tool, two 18V lithium-ion battery packs and a charger.

EDTA22CKT
Tool and Charger

EDTA22P

Pneumatic Dispensing Tool for 22 oz. Cartridges

The EDTA22P tool features an optional suitcase handle adapter for the ultimate in tool configuration and dispensing convenience, enabling easier and time-saving ground-level doweling. The heavy-duty tool comes with a custom, blow-molded plastic carrying case.



EDTA22P

EDTA56P

Pneumatic Dispensing Tool for 56 oz. Cartridges

The EDTA56P tool features an optional suitcase handle adapter for the ultimate in tool configuration and dispensing convenience, enabling easier and time-saving ground-level doweling. The heavy-duty tool comes with a custom, blow-molded plastic carrying case.



EDTA56P

Description	Model No.
Premium tool for single-tube cartridges	CDT10S
Manual tool for 22 oz. cartridges	EDT22S
Replacement 14.4V battery (ea.)	EDT14B
Battery-powered tool for 22 oz. cartridges	EDTA22CKT
Pneumatic tool for 22 oz. cartridges ^{1,2}	EDTA22P
Pneumatic tool for 56 oz. cartridges ^{1,2}	EDTA56P

1. Air supply attachment is 1/4-18 NPT (male) thread.
2. Recommended operating air pressure is between 80 and 100 psi.

Maintenance tips, troubleshooting and repair parts schematics available at www.strongtie.com.

Adhesive Accessories

ADT813S**Manual Dispensing Tool for 12.5 oz. Cartridges**

The ADT813S features a steel carriage for ultimate durability. The ADT813S also features double-gripping plates that help extend tool life.



ADT813S

ADT30S**Manual Dispensing Tool for 30 oz. Acrylic-Tie® Adhesive Cartridges**

The ADT30S features a steel carriage for ultimate durability and is engineered for continuous, high-volume use, as well as double-gripping plates that help extend tool life.



ADT30S

ADTA30CKT**Battery-Powered Dispensing Tool for 30 oz. Cartridges**

The ADTA30C offers power dispensing of 30 oz., 10:1 ratio, dual-cartridge adhesives without the need for a hose or compressor. The tool features dosage and rate control for maximum efficiency on the job. The 18V lithium-ion battery is 50% lighter than NiCad and offers 40% longer run time. Recharging takes only 30 minutes. The ADTA30CKT comes with the dispensing tool, two 18V Lithium-ion battery packs and a charger.



ADTA30CKT

ADTA30P**Pneumatic Dispensing Tool for 30 oz. Cartridges**

The ADTA30P tool features an optional suitcase handle adapter for flexible tool configuration and dispensing convenience. The suitcase option enables easier and time-saving ground-level doweling. The heavy-duty tool comes with a custom, blow-molded plastic carrying case.



ADTA30P

Description	Model No.
Manual tool for 12.5 oz. cartridges	ADT813S
Manual tool for 30 oz. cartridges	ADT30S
Battery-powered tool for 30 oz. cartridges	ADTA30CKT
Pneumatic tool for 30 oz. cartridges ^{1,2}	ADTA30P

1. Air supply attachment is 1/4-18 NPT (male) thread.
2. Recommended operating air pressure is between 80 and 120 psi .

Maintenance tips, troubleshooting and repair parts schematics available at www.strongtie.com.

Adhesive Accessories

Mixing Nozzles

Mixing nozzles are designed for the proper proportioning and mixing of the different adhesive formulations. Use only the appropriate Simpson Strong-Tie® mixing nozzle in accordance with Simpson Strong-Tie instructions. Modification or improper use of the mixing nozzle may impair epoxy or acrylic performance.

EMN22i

An 18-element mixing nozzle with integrated nut for use with 22 oz. and 56 oz. epoxy adhesive cartridges.



EMN22i

EMN37A

An 18-element, high-strength, mixing nozzle for dispensing epoxy adhesive through bulk metering equipment.



EMN37A

EMN50

A high-volume nozzle for 22 oz. and 56 oz. epoxy cartridges.



EMN50

AMN19Q

A 19-element high-strength static mixing nozzle for use with all acrylic adhesive products.

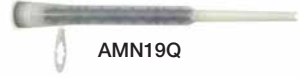

AMN19Q

Description	Model No.	Package Quantity	Carton Quantity
Mixing nozzle for 1.7 oz. SET 1.7 KTA cartridge (separate retaining nut not required)	EMN1.7-R	2	24 Packs (2 nozzles per pack)
18-element nozzle for 22 oz. and 56 oz. epoxy adhesives. Features an integrated threaded nut for attachment to cartridges.	EMN22i	1	12 Nozzles
	EMN22i-RP5	5	6 Packs (5 nozzles per pack)
	EMN22i-RP10	10	3 Packs (10 nozzles per pack)
	EMN22iB	—	500
18-element nozzle for dispensing epoxy through metering equipment	EMN37A-RP5	5	6 Packs (5 nozzles per pack)
High-volume nozzle for 22 oz. and 56 oz. cartridges (separate retaining nut not required), 17" long, major diameter 7/8"	EMN50	—	10
A 19-element nozzle for all acrylic adhesives	AMN19Q-RP5	5	10 Packs (5 nozzles per pack)

Adhesive Accessories

Piston Plug Adhesive Delivery System

The Simpson Strong-Tie® Piston Plug Adhesive Delivery System offers you an easy-to-use, more reliable and less time-consuming means to dispense adhesive into drilled holes for threaded rod and rebar dowel installations at overhead, upwardly inclined and horizontal orientations.

The matched tolerance design between the piston plug and drilled hole virtually eliminates the formation of voids and air pockets during adhesive dispensing.

Features

- Designed for dispensing adhesive into drilled holes at overhead, upwardly inclined and horizontal orientations, as well as deep embedments
- Suitable for use with all Simpson Strong-Tie anchoring adhesives
- Adhesive piston plugs are sized to fit each drilled hole diameter
- Model number is embossed on each adhesive piston plug for identification
- A barbed end provides a reliable connection to the flexible extension tubing
- Flexible extension tubing is available in 25-foot-long rolls to be cut to required lengths



Adhesive Piston Plugs

Model No.	Drill Bit Diameter	Package Quantity	Carton Quantity*
PP56-RP10	9/16"	10	100
PP62-RP10	5/8"	10	100
PP68-RP10	1 1/16"	10	100
PP75-RP10	3/4"	10	100
PP81-RP10	13/16"	10	100
PP87-RP10	7/8"	10	100
PP100-RP10	1"	10	100
PP112-RP10	1 1/8"	10	100
PP137-RP10	1 3/8"	10	100
PP175-RP10	1 3/4"	10	100

*10 packages of 10

Adhesive Tubing

Model No.	Description	Package Quantity
PPFT25	Piston Plug Adhesive Flexible Tubing — 25 ft. roll	1

Adhesive Accessories

Adhesive Retaining Caps

Adhesive retaining caps make overhead and horizontal installation easier by preventing the adhesive from running out of the hole. They also center the rod in the hole, making them ideal for applications where precise anchor placement is required. It may be necessary to provide support for the insert during cure time. Adhesive retaining caps are not designed to support the weight of the insert in overhead installations.

Material: Plastic



Adhesive Retaining Caps

Adhesive Retaining Caps

Drill Bit Diameter (in.)	Anchor Diameter (in.)	Rebar Size	Model No.	Cap Depth (in.)	Package Quantity	Carton Quantity* (ea.)
7/16	3/8	#3	ARC37A-RP25	7/16	25	200
1/2	3/8		ARC37-RP25	7/16	25	200
9/16	1/2	#4	ARC50A-RP25	1/2	25	200
5/8	1/2		ARC50-RP25	1/2	25	200
1 1/16	5/8	#5	ARC62A-RP25	9/16	25	200
3/4	5/8		ARC62-RP25	9/16	25	200
13/16	3/4	#6	ARC75A-RP25	9/16	25	200
7/8	3/4		ARC75-RP25	9/16	25	200
1	7/8	#7	ARC87-RP25	1 1/16	25	200
1 1/16	1	#8	ARC100A-RP25	1 1/16	25	200
1 1/8	1		ARC100-RP25	1 1/16	25	200
1 3/8	1 1/4	#10	ARC125-RP25	7/8	25	200
1 3/4	—	#11	ARC137-RP25	1 1/16	25	200

*8 packages of 25.

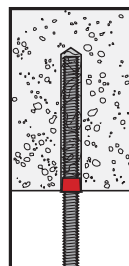
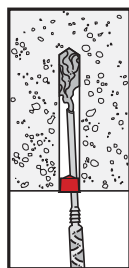

The "X" cut in the cap allows the mixing nozzle and insert to pass through, while containing the adhesive in the hole.

Steel Adhesive-Anchoring Screen Tubes

Screen tubes are used in hollow base material applications to contain adhesive around the anchor and prevent it from running into voids. Simpson Strong-Tie® screen tubes are specifically designed to work with AT, SET and ET-HP® adhesives in order to precisely control the amount of adhesive that passes through the mesh. This results in thorough coating and bonding of the rod to the screen tube and base material. Order screen tubes based upon rod diameter and adhesive type. The actual outside diameter of the screen tube is larger than the rod diameter.

Material: Acrylic screen tubes: 50 mesh stainless steel
Epoxy screen tubes: 60 mesh carbon steel



Caution: Screen tubes are designed for a specific adhesive type. Epoxy screen tubes must be used with SET or ET-HP® formulations and acrylic screen tubes must be used with AT.



Epoxy Screen Tube
(Acrylic screen tubes similar)

Screen tubes are for use in hollow CMU, hollow brick and unreinforced masonry applications. Contact Simpson Strong-Tie for information on special-order sizes.

Acrylic Adhesive (AT) Screen Tubes – Stainless Steel

For Rod Diameter (in.)	Hole Size (in.)	Actual Screen Size O.D./Length (in.)	Model No.	Carton Quantity
3/8	9/16	1 ⁵ / ₃₂ X 3 1/2	ATS373	150
		1 ⁵ / ₃₂ X 6	ATS376	150
1/2	1 ¹ / ₁₆	1 ⁹ / ₃₂ X 3 1/2	ATS503	100
		1 ⁹ / ₃₂ X 6	ATS506	100
		1 ⁹ / ₃₂ X 10	ATS5010	50
5/8	7/8	2 ⁵ / ₃₂ X 3	ATS623	50
		2 ⁵ / ₃₂ X 6	ATS626	50
		2 ⁵ / ₃₂ X 10	ATS6210	25
		2 ⁵ / ₃₂ X 13	ATS6213	25
3/4	1	3 ¹ / ₃₂ X 8	ATS758	25
		3 ¹ / ₃₂ X 13	ATS7513	25
		3 ¹ / ₃₂ X 17	ATS7517	25

Epoxy Adhesive (SET and ET-HP®) Screen Tubes – Carbon Steel

For Rod Diameter (in.)	Hole Size (in.)	Actual Screen Size O.D./Length (in.)	Model No.	Carton Quantity
3/8	9/16	1 ⁵ / ₃₂ X 6	ETS376	150
		1 ⁵ / ₃₂ X 10	ETS3710	100
1/2	1 ¹ / ₁₆	1 ⁹ / ₃₂ X 6	ETS506	100
		1 ⁹ / ₃₂ X 10	ETS5010	50
5/8	7/8	2 ⁵ / ₃₂ X 6	ETS626	50
		2 ⁵ / ₃₂ X 10	ETS6210	25
		2 ⁵ / ₃₂ X 13	ETS6213	25
3/4	1	3 ¹ / ₃₂ X 8	ETS758	25
		3 ¹ / ₃₂ X 13	ETS7513	25
		3 ¹ / ₃₂ X 17	ETS7517	25
		3 ¹ / ₃₂ X 21	ETS7521	25

Note: Not for use with SET1.7KTA.

Adhesive Accessories

Opti-Mesh Adhesive-Anchoring Screen Tubes

Screen tubes are vital to the performance of adhesive anchors in base materials that are hollow or contain voids, such as hollow block and brick. The Simpson Strong-Tie® Opti-Mesh screen tube provides the economical advantage of a plastic screen tube while providing performance comparable to steel screen tubes and better than competitive plastic screen tubes.

Material: Plastic



Caution: Screen tubes are designed for a specific adhesive type. Epoxy screen tubes must be used with SET-XP®, ET-HP® or SET formulations, and acrylic adhesive screen tubes must be used with AT.



Integral Cap: Serves to center and secure the rod in the screen tube, while displaying important information such as rod diameter, drill bit diameter and the Simpson Strong-Tie® “+” symbol for easy inspection after installation. The cap also prevents adhesive from running out the front of the screen tube.

Flanges: Prevents the screen tube from slipping into over-drilled holes. Allows screen tube to function in holes that are drilled too deep.

Open-Mesh Collar: This section of larger mesh allows extra adhesive to flow out the screen tube behind the face shell of hollow block applications. The extra “collar” of adhesive increases bearing area and results in higher load capacities in hollow concrete block.

Color-Coded, Formula-Specific Mesh: The screen tube mesh is sized to allow only the right amount of adhesive to flow through the screen tube to bond with the base material while the balance remains in the screen to bond the rod. The acrylic screen tube mesh is white, while the epoxy screen tube mesh is black.

Epoxy Adhesive Screen Tube
(mesh is black)

U.S. Patent 6,837,018



The integral cap centers the rod and displays drill bit and rod diameter.

Adhesive Accessories

Opti-Mesh Adhesive-Anchoring Screen Tubes (cont.)

Epoxy Adhesive (SET-XP®, ET-HP® and SET) Screen Tubes – Plastic

For Rod Diameter (in.)	Hole Size (in.)	Length (in.)	Model No.	Carton Quantity
3/8	9/16	3 1/2	ETS373P	150
		6	ETS376P	150
		10	ETS3710P	100
1/2	3/4	3 1/2	ETS503P	100
		6	ETS506P	100
		10	ETS5010P	50
5/8	7/8	3 1/2	ETS623P	50
		6	ETS626P	50
		10	ETS6210P	25
		13	ETS6213P	25
3/4	1	8	ETS758P	25
		13	ETS7513P	25
		17	ETS7517P	25
		21	ETS7521P	25

Not for use with SET1.7KTA.

Acrylic Adhesive (AT) Screen Tubes – Plastic

For Rod Diameter (in.)	Hole Size (in.)	Length (in.)	Model No.	Carton Quantity
3/8	9/16	3 1/2	ATS373P	150
		6	ATS376P	150
		10	ATS3710P	100
1/2	3/4	3 1/2	ATS503P	100
		6	ATS506P	100
		10	ATS5010P	50
5/8	7/8	3 1/2	ATS623P	50
		6	ATS626P	50
		10	ATS6210P	25
		13	ATS6213P	25
3/4	1	8	ATS758P	25
		13	ATS7513P	25
		17	ATS7517P	25
		21	ATS7521P	25

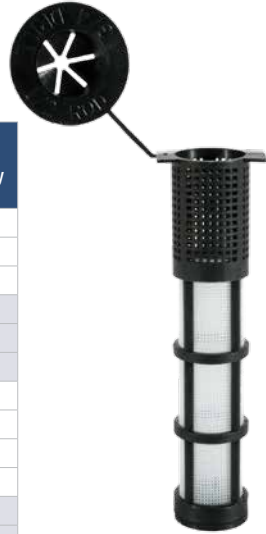

Acrylic Adhesive Screen Tube
(mesh is white)

Adhesive Accessories

Hole-Cleaning Brushes

Brushes are used for cleaning drilled holes prior to adhesive anchor installation. Brushes have a twisted wire handle with nylon bristles.



Description	Model No.	For Anchor/Rebar Diameter (in.)	For Hole Diameter (in.)	Carton Quantity
½" x 3" brush (8" total length)	ETB4	¼" – ⅝"	⅜" – 7/16"	24
¾" x 4" brush (16" total length)	ETB6	⅜" – ⅝"	½" – ¾"	24
1" x 4" brush (16" total length)	ETB8	¾"	1⅜" – 7/8"	24
1" x 4" brush (24" total length)	ETB8L	¾"	1⅜" – 7/8"	24
1¼" x 4" brush (29" total length)	ETB10	7/8" – 1"	1" – 1 1/8"	24
1⅝" x 6" brush (34" total length)	ETB12	1 ¼"	1 ⅜" – 1 ⅝"	24

Adhesive Shear Tubes

Used in conjunction with anchoring adhesive and screen tubes, adhesive shear tubes transfer anchor shear loads over a larger area, reducing localized crushing in unreinforced masonry installations. Required for through-bolt applications per ICC-ES's unreinforced masonry anchorage "Configuration C" detail. For detailed installation instructions, refer to the appropriate adhesive anchor ICC-ES report.

MATERIAL: Steel

FINISH: Zinc-plated



Adhesive Shear Tube

Description (in.)	Model No.	For use with Simpson Screen Model No. ¹	Drill Bit Diameter (in.)	Threaded Rod Diameter (in.)	Carton Quantity
1⅜ x 8	AST800	ETS758, ATS758	1	⅝	1

1. Screens sold separately. Not for use with Simpson Strong-Tie® screen ETS758P or ATS758P plastic Opti-Mesh screen tubes.

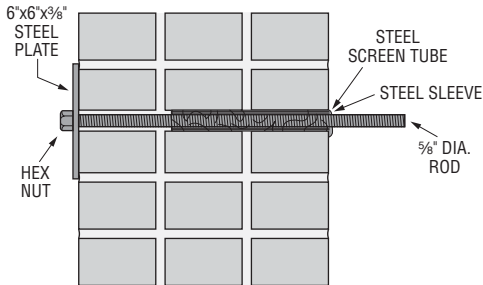

Configuration C

Adhesive Accessories

Retrofit Bolts

RFBs are pre-cut threaded rod, supplied with nut and washer. For use with Simpson Strong-Tie® adhesives. May be ordered in bulk without the nut and washer. Use with Simpson Strong-Tie adhesives to anchor into existing concrete and masonry. Each end of the threaded rod is stamped with rod length in inches and our “No-Equal” symbol for easy identification after installation.

MATERIAL: ASTM F1554 Grade 36

COATING: Zinc-plated, hot-dip galvanized



RFB
Retrofit Bolts

Description Diameter Length	Zinc-Plated Model No.	Hot-Dip Galvanized Model No.	Carton Quantity	Retail ² Pack
1/2" x 4"	RFB#4x4	RFB#4x4HDG	50	—
1/2" x 5"	RFB#4x5	RFB#4x5HDG	50	10
1/2" x 6"	RFB#4x6	RFB#4x6HDG	50	10
1/2" x 7"	RFB#4x7	RFB#4x7HDG	50	10
1/2" x 8"	—	RFB#4x8HDG	—	10
1/2" x 10"	RFB#4x10	RFB#4x10HDG	25	10
5/8" x 5"	RFB#5x5	RFB#5x5HDG	50	10
5/8" x 8"	RFB#5x8	RFB#5x8HDG	50	10
5/8" x 10"	RFB#5x10	RFB#5x10HDG	50	10
5/8" x 12"	—	RFB#5x12HDG	—	10
5/8" x 16"	RFB#5x16	RFB#5x16HDG	25	10
3/4" x 10 1/2"	RFB#6x10.5	RFB#6x10.5HDG	25	—

1. Bulk quantities do not include the nut and washer and must be ordered with a “-B” suffix (example: RFB#4x5-B). Hot-dip galvanized RFBs not available in bulk.
2. Retail packs must be ordered with an “-R” suffix (example: RFB#5x12HDG-R).

Adhesive Accessories

Speed Clean™ Dust Extraction System

Drill cleaner holes faster and more reliably

Developed in conjunction with the Bosch Alliance partnership, the Simpson Strong-Tie® Speed Clean™ Dust Extraction System is a comprehensive drill bit-and-vacuum system that reduces dust while producing precise, clean holes for adhesive anchor installation. Speed Clean drill bits work in conjunction with Bosch vacuum systems and rotohammers to offer best-in-class concrete drilling.*

- **Faster:**
 - Drills up to 20% faster in low-strength concrete
 - Saves labor time – eliminates need for blow-brush-blow hole-cleaning process
- **Cleaner:**
 - Reduces airborne silica dust from hole drilling
 - May significantly reduce dust fallout from overhead drilling
 - Limits concrete dust build-up at jobsite
- **More Reliable:**
 - Speed Clean drills and cleans holes to meet published bond strengths of AT-XP® and SET-XP® anchoring adhesives**



Speed Clean™ System

Solid carbide tips embedded in a steel head

Internal dust extraction channel

Drill bit sizes available to fit SDS-PLUS and SDS-MAX rotohammers

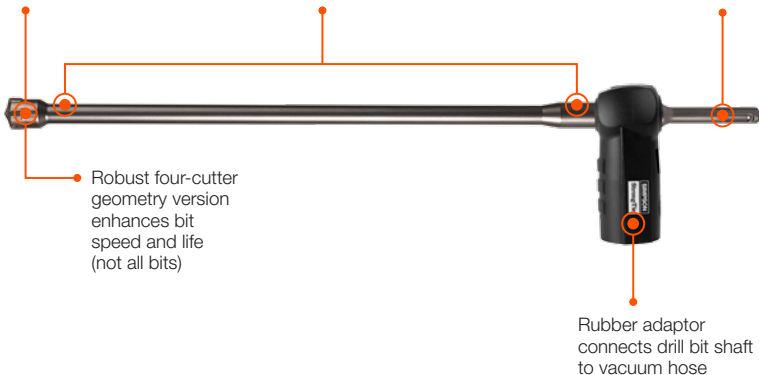

*Minimum vacuum airflow: 150 cfm with auto-filter cleaner.
Maximum rotary hammer no-load RPM: 760.

**Does not apply to 7/16", 1/2" and 9/16" drill bits.

Speed Clean™ Dust Extraction System (cont.)

Speed Clean™ Dust Extraction System – Drill Bits for SET-XP®

Model No.	Description	Size	For Insert Diameter	Retail Pack	Carton Quantity
DXS-PL06215Q	SDS-PLUS, 4 cutter	5/8" x 10"	1/2"	1 bit + adaptor	8
DXS-PL07518Q	SDS-PLUS, 4 cutter	3/4" x 12 1/2"	5/8"	1 bit + adaptor	8
DXS-MX07521Q	SDS-MAX, 4 cutter	3/4" x 12 1/2"	5/8"	1 bit + adaptor	8
DXS-MX08725Q	SDS-MAX, 4 cutter	7/8" x 15"	3/4"	1 bit + adaptor	8
DXS-MX10027Q	SDS-MAX, 4 cutter	1" x 17 1/2"	7/8"	1 bit + adaptor	8
DXS-MX11229Q	SDS-MAX, 4 cutter	1 1/8" x 20"	1"	1 bit + adaptor	8
DXS-MX11834Q	SDS-MAX, 4 cutter	1 3/8" x 25"	1 1/4"	1 bit + adaptor	8

Speed Clean™ Dust Extraction System – Drill Bits for AT-XP®

Model No.	Description	Size	For Insert Diameter	Retail Pack	Carton Quantity
DXS-PL06818Q	SDS-PLUS, 4 cutter	1 1/16" x 12 1/2"	5/8"	1 bit + adaptor	8
DXS-MX08125Q	SDS-MAX, 4 cutter	1 3/16" x 15"	3/4"	1 bit + adaptor	8
DXS-MX10027Q	SDS-MAX, 4 cutter	1" x 17 1/2"	7/8"	1 bit + adaptor	8
DXS-MX11229Q	SDS-MAX, 4 cutter	1 1/8" x 20"	1"	1 bit + adaptor	8
DXS-MX11834Q	SDS-MAX, 4 cutter	1 3/8" x 25"	1 1/4"	1 bit + adaptor	8

Speed Clean™ Dust Extraction System – Adaptors

Model No.	Description	Retail Pack	Carton Quantity
DXS-MXADP	SDS-MAX adaptor	1 adaptor	10
DXS-PLADP	SDS-PLUS + adaptor	1 adaptor	10

Mechanical Anchors



SIMPSON**Strong-Tie**[®]

From complex infrastructure projects to do-it-yourself ventures, Simpson Strong-Tie offers a wide variety of anchoring products to meet virtually any need.

Our mechanical anchors are designed to install easily and securely into a variety of base materials — from concrete and brick to hollow and grouted CMU. They offer optimal performance even in the most demanding structural applications. For applications where there is a risk of concrete cracking, specific anchors have been designed and tested to offer reliability under these conditions.



Torq-Cut™ Self-Undercutting Anchor

The Torq-Cut™ self-undercutting anchor is a heavy-duty, high-capacity anchor developed and tested for use in cracked and uncracked concrete under static and seismic conditions. The Torq-Cut features a built-in, hardened cutting ring that expands with installation torque, forming undercut grooves in the concrete. This interlock between the anchor and the concrete provides superior load-carrying capacity.



Torq-Cut™
Self-Undercutting
Anchor
U.S. Patent 7,357,613

Features

- Code listed under IBC/IRC for cracked and uncracked concrete per ICC-ES ESR-2705
- Self-undercutting feature provides higher load-carrying capacity than conventional mechanical anchors
- Qualified for static and seismic loading conditions (seismic design categories A through F)
- Ductile steel rod provides consistent, reliable performance
- Specially designed, low-friction expansion cone minimizes binding and speeds installation
- Installation requires no special drill bit or secondary drilling operation
- Head is stamped with the Simpson Strong-Tie® “S” sign and anchor size identification for easy post-installation verification

Codes: ICC-ES ESR-2705 (concrete); City of L.A. RR25946 (concrete); Florida FL-15731.3

Material: Carbon steel

Coating: Zinc plated or sherardized

Torq-Cut™ Setting Tool

The TCAST is the steel setting tool used to install the Torq-Cut self-undercutting anchor, driving the anchor into the pre-drilled hole and protecting the threads on the Torq-Cut anchor from being damaged by hammer blows.

Installation Instructions: See page 190.



Torq-Cut™
Setting Tool
(Sold separately)



Torq-Cut™ Self-Undercutting Anchor

Torq-Cut™ Anchor Product Data, Pre-Set Version

Size (in.)	Model No.	Drill Bit Dia. (in.)	Min. Drilled Hole Depth (A) (in.)	Min. Nominal Embed. Depth, h _{nom} (B) (in.)	Max. Fixture Thickness (F) (in.)	Min. Fixture Hole Dia. (in.)	Threaded Rod Length (D) (in.)	Quantity	
								Box	Carton
½ x 8¾	TCAP500834	⅞	7	6⅝	1¼	⅞	8¾	5	10
½ x 9½	TCAP500912	⅞	7	6⅝	2	⅞	9½	5	10
⅝ x 11½	TCAP621112	1	9½	8⅞	1½	1⅛	11½	4	8
⅝ x 12½	TCAP621212	1	9½	8⅞	2½	1⅛	12½	4	8
¾ x 14⅝	TCAP751458	1¼	12	11⅞	2	1⅜	14⅝	4	8
¾ x 16⅝	TCAP751658	1¼	12	11⅞	4	1⅜	16⅝	4	8

Torq-Cut™ Anchor Product Data, Through-Set Version

Size (in.)	Model No.	Drill Bit Dia. (in.)	Min. Drilled Hole Depth (A) (in.)	Min. Nominal Embed. Depth, h _{nom} (B) (in.)	Max. Fixture Thickness (F) (in.)	Min. Fixture Hole Dia. (in.)	Threaded Rod Length (D) (in.)	Quantity	
								Box	Carton
½ x 8¾	TCAT500834	⅞	7	6⅝	1¼	1⅝	8¾	5	10
½ x 9½	TCAT500912	⅞	7	6⅝	2	1⅝	9½	5	10
⅝ x 11½	TCAT621112	1	9½	8⅞	1½	1⅛	11½	4	8
⅝ x 12½	TCAT621212	1	9½	8⅞	2½	1⅛	12½	4	8
¾ x 14⅝	TCAT751458	1¼	12	11⅞	2	1⅝	14⅝	4	8
¾ x 16⅝	TCAT751658	1¼	12	11⅞	4	1⅝	16⅝	4	8

Torq-Cut™ Self-Undercutting Anchor

Torq-Cut™ Anchor Material Specifications*

Carbon Steel Component Materials						
Threaded Rod		Nut	Washer	Spacer Sleeve	Undercut Expansion Ring	Expansion Cone
Material	ASTM A193 Grade B7M	SAE J995, Grade 8	ASTM F436, Type 1	SAE J403 Grade 1045 Steel	SAE J403 Grade 1045 Steel	SAE J403 Grade 1144 Steel
Coating	Zinc Plated ASTM B633 SC1	Zinc plated	Zinc plated	Zinc Plated ASTM B633 SC1	Zinc Plated ASTM B633 SC1	Zinc Plated ASTM B633 SC1

*For added corrosion resistance, TCA with a sherardized coating is available by special order.

Torq-Cut™ Anchor Installation Data

Nominal Anchor Diameter (in.)	1/2	5/8	3/4
Drill Bit Size (in.)	7/8	1	1 1/4
Fixture Hole Diameter Range Pre-Set (in.)	9/16–3/4	1 1/16–7/8	1 3/16–1 1/8
Min. Fixture Hole Diameter Through-Set (in.)	15/16	1 1/16	1 5/16
Wrench Size (in.)	3/4	15/16	1 1/8
Setting Tool Required	TCAST50	TCAST62	TCAST75

1. The Drilled Hole Depth is 1/2" greater than the Nominal Embedment Depth.
2. For the Through-Set version of the Torq-Cut anchor, if the actual Fixture Thickness (t_{fix}) is less than the Maximum Fixture Thickness (F), the Minimum Drilled Hole Depth (A) must be increased as follows:

$$\text{Drilled Hole Depth} = A + (F - t_{fix})$$

Similarly, the Minimum Nominal Embedment Depth (B) is increased as follows:

$$\text{Nominal Embedment Depth} = B + (F - t_{fix})$$

Strong-Bolt® 2 Wedge Anchor

A wedge-type expansion anchor designed for optimal performance in cracked and uncracked concrete as well as uncracked masonry. The Strong-Bolt® 2 is available in carbon steel (¼" through 1" diameter), Type 304 (¼" diameter only) and Type 316 stainless steel (¼" through ¾" diameter).



Features

- Code listed under IBC/IRC for cracked and uncracked concrete per ICC-ES ESR-3037
- Code listed under IBC/IRC for masonry per IAPMO UES ER-240
- Qualified for static and seismic loading conditions (seismic design categories A through F)
- Suitable for horizontal, vertical and overhead applications
- Qualified for minimum concrete thickness of 3¼", and lightweight concrete-over-metal deck thickness of 2½" and 3¼"
- Standard (ANSI) fractional sizes: fits standard fixtures and installs with common drill bit and tool sizes

Codes: ICC-ES ESR-3037 (concrete); IAPMO UES ER-240 (carbon steel in CMU); City of L.A. RR25891 (concrete), RR25936 (carbon steel in CMU); Florida FL-15731.2; FL-16230.4; UL File Ex3605; FM 3043342 and 3047639; Multiple DOT listings; meets the requirements of Federal Specifications A-A-1923A, Type 4

Material: Carbon-steel stud with special alloy clip; stainless-steel stud with stainless-steel clip

Coating: Zinc plated

Installation Instructions: See page 191.



Head Stamp

The head is stamped with the length identification letter, bracketed top and bottom by horizontal lines.



Strong-Bolt® 2 Wedge Anchor

Material Specifications

Anchor Body	Nut	Washer	Clip
Carbon Steel ¹	Carbon Steel, ASTM A563, Grade A	Carbon Steel ASTM F844	Carbon Steel ASTM A568
Type 304 Stainless Steel	Type 304 Stainless Steel	Type 304 Stainless Steel	Type 316 Stainless Steel
Type 316 Stainless Steel	Type 316 Stainless Steel	Type 316 Stainless Steel	Type 316 Stainless Steel

1. Zinc meets ASTM B633, Class SC 1 (Fe / Zn 5), Type III.

Strong-Bolt® 2 Wedge Anchor

Strong-Bolt® 2 Anchor Installation Data

Strong-Bolt 2 Diameter (in.)	¼	⅜	½	⅝	¾	⅞	1
Drill Bit Size (in.)	¼	⅜	½	⅝	¾	⅞	1
Min. Fixture Hole (in.)	⅝ ₁₆	7 ₁₆	9 ₁₆	11 ₁₆	7 ₈	1	1 1 ₈
Wrench Size (in.)	7 ₁₆	9 ₁₆	¾	15 ₁₆	1 1 ₈	1 5 ₁₆	1 ½

Strong-Bolt® 2 Anchor Product Data

Size (in.)	Carbon Steel Model No.	Type 304 Stainless Steel Model No.	Type 316 Stainless Steel Model No.	Drill Bit Dia. (in.)	Thread Length (in.)	Quantity	
						Box	Carton
¼ x 1 ¼	STB2-25134	STB2-251344SS	STB2-251346SS	¼	1 5 ₁₆	100	500
¼ x 2 ¼	STB2-25214	STB2-252144SS	STB2-252146SS	¼	1 7 ₁₆	100	500
¼ x 3 ¼	STB2-25314	STB2-253144SS	STB2-253146SS	¼	2 7 ₁₆	100	500
⅜ x 2 ¾	STB2-37234	—	STB2-372346SS	⅜	1 5 ₁₆	50	250
⅜ x 3	STB2-37300	—	STB2-373006SS	⅜	1 9 ₁₆	50	250
⅜ x 3 ½	STB2-37312	—	STB2-373126SS	⅜	2 1 ₁₆	50	250
⅜ x 3 ¾	STB2-37334	—	STB2-373346SS	⅜	2 5 ₁₆	50	250
⅜ x 5	STB2-37500	—	STB2-375006SS	⅜	3 9 ₁₆	50	200
⅜ x 7	STB2-37700	—	STB2-377006SS	⅜	5 9 ₁₆	50	200
½ x 3 ¾	STB2-50334	—	STB2-503346SS	½	2 1 ₁₆	25	125
½ x 4 ¾	STB2-50434	—	STB2-504346SS	½	3 1 ₁₆	25	100
½ x 5 ½	STB2-50512	—	STB2-505126SS	½	3 13 ₁₆	25	100
½ x 7	STB2-50700	—	STB2-507006SS	½	5 5 ₁₆	25	100
½ x 8 ½	STB2-50812	—	STB2-508126SS	½	6	25	50
½ x 10	STB2-50100	—	STB2-501006SS	½	6	25	50
⅝ x 4 ½	STB2-62412	—	STB2-624126SS	⅝	2 7 ₁₆	20	80
⅝ x 5	STB2-62500	—	STB2-625006SS	⅝	2 15 ₁₆	20	80
⅝ x 6	STB2-62600	—	STB2-626006SS	⅝	3 15 ₁₆	20	80
⅝ x 7	STB2-62700	—	STB2-627006SS	⅝	4 15 ₁₆	20	80
⅝ x 8 ½	STB2-62812	—	STB2-628126SS	⅝	6	20	40
⅝ x 10	STB2-62100	—	STB2-621006SS	⅝	6	10	20
¾ x 5 ½	STB2-75512	—	STB2-755126SS	¾	3 3 ₁₆	10	40
¾ x 6 ¼	STB2-75614	—	STB2-756146SS	¾	3 15 ₁₆	10	40
¾ x 7	STB2-75700	—	STB2-757006SS	¾	4 11 ₁₆	10	40
¾ x 8 ½	STB2-75812	—	STB2-758126SS	¾	6	10	20
¾ x 10	STB2-75100	—	—	¾	6	10	20
1 x 7	STB2-100700	—	—	1	3 ½	5	20
1 x 10	STB2-1001000	—	—	1	3 ½	5	10
1 x 13	STB2-1001300	—	—	1	3 ½	5	10

Wedge-All® Wedge Anchor

A non-bottom-bearing, wedge-style expansion anchor for use in solid concrete or grout-filled masonry. The Wedge-All® wedge anchor is available in carbon steel with zinc or mechanically galvanized coating, as well as Types 303/304 and Type 316 stainless steel. Threaded studs are set by tightening the nut to the specified torque. The Wedge-All is code listed for grout-filled masonry applications.

Features

- Code listed under IBC/IRC for grout-filled CMU per ICC-ES ESR-1396
- One-piece, wrap-around clip ensures uniform holding capacity
- Threaded end is chamfered for ease of starting nut
- Available in a wide range of diameters and lengths

Codes: ICC-ES ESR-1396 (CMU); Florida FL-15730.7; FM 3017082 and 3131136; UL File Ex3605; Multitple DOT listings; meets the requirements of Federal Specification A-A-1923A, Type 4

Material: Carbon or stainless steel (Types 303/304; Type 316)

Coating: Carbon steel anchors are available zinc plated or mechanically galvanized

Installation Instructions: See page 192.



Head Stamp

The head is stamped with the length identification letter.



Wedge-All® Anchor



Wedge-All® Anchor Installation Data

Wedge-All Diameter (in.)	¼	⅜	½	⅝	¾	⅞	1	1¼
Drill Bit Size (in.)	¼	⅜	½	⅝	¾	⅞	1	1¼
Min. Fixture Hole (in.)	⅝	⅞	⅞	1⅛	⅞	1	1⅛	1⅜
Wrench Size (in.)	⅞	⅞	¾	1⅝	1⅞	1⅝	1½	1⅞

Wedge-All® Wedge Anchor

Wedge-All® Anchor Product Data — Carbon Steel:
Zinc Plated and Mechanically Galvanized

Size (in.)	Zinc Plated Model No.	Mechanically Galvanized Model No.	Drill Bit Diameter (in.)	Thread Length (in.)	Quantity	
					Box	Carton
¼ x 1¾	—	WA25134MG	¼	1 ⁵ / ₁₆	100	500
¼ x 2¼	—	WA25214MG		1 ⁷ / ₁₆	100	500
¼ x 3¼	—	WA25314MG		2 ⁷ / ₁₆	100	500
⅜ x 2¼	WA37214	WA37214MG	⅜	1½	50	250
⅜ x 2¾	WA37234	WA37234MG		1 ⁵ / ₈	50	250
⅜ x 3	WA37300	WA37300MG		1 ⁷ / ₈	50	250
⅜ x 3½	WA37312	WA37312MG		2½	50	250
⅜ x 3¾	WA37334	WA37334MG		2 ⁵ / ₈	50	250
⅜ x 5	WA37500	WA37500MG		3 ⁷ / ₈	50	200
⅜ x 7	WA37700	WA37700MG		5 ⁷ / ₈	50	200
½ x 2¾	WA50234	WA50234MG	½	1 ⁵ / ₁₆	25	125
½ x 3¾	WA50334	WA50334MG		2 ⁵ / ₁₆	25	125
½ x 4¼	WA50414	WA50414MG		2 ¹³ / ₁₆	25	100
½ x 5½	WA50512	WA50512MG		4 ¹ / ₁₆	25	100
½ x 7	WA50700	WA50700MG		4 ⁹ / ₁₆	25	100
½ x 8½	WA50812	WA50812MG		6	25	50
½ x 10	WA50100	WA50100MG		6	25	50
½ x 12	WA50120	WA50120MG	6	25	50	
⅝ x 3½	WA62312	WA62312MG	⅝	1 ⁷ / ₈	20	80
⅝ x 4½	WA62412	WA62412MG		2 ⁷ / ₈	20	80
⅝ x 5	WA62500	WA62500MG		3 ³ / ₈	20	80
⅝ x 6	WA62600	WA62600MG		4 ³ / ₈	20	80
⅝ x 7	WA62700	WA62700MG		5 ³ / ₈	20	80
⅝ x 8½	WA62812	WA62812MG		6	20	40
⅝ x 10	WA62100	WA62100MG		6	10	20
⅝ x 12	WA62120	WA62120MG	6	10	20	
¾ x 4¼	WA75414	WA75414MG	¾	2 ³ / ₈	10	40
¾ x 4¾	WA75434	WA75434MG		2 ⁷ / ₈	10	40
¾ x 5½	WA75512	WA75512MG		3 ³ / ₈	10	40
¾ x 6¼	WA75614	WA75614MG		4 ³ / ₈	10	40
¾ x 7	WA75700	WA75700MG		5 ¹ / ₈	10	40
¾ x 8½	WA75812	WA75812MG		6	10	20
¾ x 10	WA75100	WA75100MG		6	10	20
¾ x 12	WA75120	WA75120MG	6	5	10	
7⁄8 x 6	WA87600	WA87600MG	7⁄8	2½	5	20
7⁄8 x 8	WA87800	WA87800MG		2½	5	10
7⁄8 x 10	WA87100	WA87100MG		2½	5	10
7⁄8 x 12	WA87120	WA87120MG		2½	5	10
1 x 6	WA16000	WA16000MG	1	2¼	5	20
1 x 9	WA19000	WA19000MG		2¼	5	10
1 x 12	WA11200	WA11200MG		2¼	5	10
1¼ x 9	WA12590	—	1¼	2¾	5	10
1¼ x 12	WA12512	—		2¾	5	10

1. The published length is the overall length of the anchor. Allow one anchor diameter for the nut and washer thickness plus the fixture thickness when selecting the minimum length.

Wedge-All® Wedge Anchor

Material Specifications

Carbon Steel – Zinc Plated			
Component Materials			
Anchor Body	Nut	Washer	Clip
Material meets minimum 70,000 psi tensile strength	Carbon Steel ASTM A563, Grade A	Carbon Steel	Carbon Steel

Application:

Interior environment, low level of corrosion resistance. See www.strongtie.com for more corrosion information.



Material Specifications

Carbon Steel – Mechanically Galvanized ¹			
Component Materials			
Anchor Body	Nut	Washer	Clip
Material meets minimum 70,000 psi tensile strength	Carbon Steel ASTM A563, Grade A	Carbon Steel	Carbon Steel

1. Mechanical Galvanizing meets ASTM B695, Class 55, Type 1.

Application:

Exterior unpolluted environment, medium level of corrosion resistance. Well suited to humid environments.



Wedge-All® Wedge Anchor

Wedge-All® Anchor Product Data — Stainless Steel

Size (in.)	Type 303/304 Stainless Model No. ²	Type 316 Stainless Model No.	Drill Bit Diameter (in.)	Thread Length (in.)	Quantity	
					Box	Carton
3/8 x 2 1/4	WA372144SS	WA372146SS	3/8	1 1/8	50	250
3/8 x 2 3/4	WA372344SS	WA372346SS		1 3/8	50	250
3/8 x 3	WA373004SS	WA373006SS		1 7/8	50	250
3/8 x 3 1/2	WA373124SS	WA373126SS		2 1/2	50	250
3/8 x 3 3/4	WA373344SS	WA373346SS		2 5/8	50	250
3/8 x 5	WA375004SS	WA375006SS		3 7/8	50	200
3/8 x 7	WA377004SS	WA377006SS		5 7/8	50	200
1/2 x 2 3/4	WA502344SS	WA502346SS	1/2	1 5/16	25	125
1/2 x 3 3/4	WA503344SS	WA503346SS		2 5/16	25	125
1/2 x 4 1/4	WA504144SS	WA504146SS		2 13/16	25	100
1/2 x 5 1/2	WA505124SS	WA505126SS		4 1/16	25	100
1/2 x 7	WA507004SS	WA507006SS		5 9/16	25	100
1/2 x 8 1/2	WA508124SS	WA508126SS		2	25	50
1/2 x 10	WA50100SS	WA501003SS		2	25	50
1/2 x 12	WA50120SS	WA501203SS	2	25	50	
5/8 x 3 1/2	WA623124SS	WA623126SS	5/8	1 7/8	20	80
5/8 x 4 1/2	WA624124SS	WA624126SS		2 7/8	20	80
5/8 x 5	WA625004SS	WA625006SS		3 3/8	20	80
5/8 x 6	WA626004SS	WA626006SS		4 3/8	20	80
5/8 x 7	WA627004SS	WA627006SS		5 3/8	20	80
5/8 x 8 1/2	WA628124SS	WA628126SS		2	20	40
5/8 x 10	WA62100SS	WA621003SS		2	10	20
5/8 x 12	WA62120SS	WA621203SS	2	10	20	
3/4 x 4 1/4	WA754144SS	WA754146SS	3/4	2 3/8	10	40
3/4 x 4 3/4	WA754344SS	WA754346SS		2 7/8	10	40
3/4 x 5 1/2	WA755124SS	WA755126SS		3 3/8	10	40
3/4 x 6 1/4	WA756144SS	WA756146SS		4 3/8	10	40
3/4 x 7	WA757004SS	WA757006SS		5 1/8	10	40
3/4 x 8 1/2	WA758124SS	WA758126SS		2 1/4	10	20
3/4 x 10	WA75100SS	WA751003SS		2 1/4	10	20
3/4 x 12	WA75120SS	WA751203SS	2 1/4	5	10	
7/8 x 6	WA87600SS	WA876003SS	7/8	2 1/8	5	20
7/8 x 8	WA87800SS	WA878003SS		2 1/8	5	10
7/8 x 10	WA87100SS	WA871003SS		2 1/8	5	10
7/8 x 12	WA87120SS	—		2 1/8	5	10
1 x 6	WA16000SS	WA160003SS	1	2 1/4	5	20
1 x 9	WA19000SS	WA190003SS		2 1/4	5	10
1 x 12	WA11200SS	WA112003SS		2 1/4	5	10

- The published length is the overall length of the anchor. Allow one anchor diameter for the nut and washer thickness plus the fixture thickness when selecting a length.
- Anchors with the "SS" suffix in the model number are manufactured from Type 303 stainless steel; the remaining anchors (with the "4SS" suffix) are manufactured from Type 304 stainless steel. Types 303 and 304 stainless steel perform equally well in certain corrosive environments.

Wedge-All® Wedge Anchor

Material Specifications

Type 303/304 Stainless Steel ¹			
Component Materials			
Anchor Body	Nut	Washer	Clip
Type 303 or 304 Stainless Steel	Type 18-8 Stainless Steel	Type 18-8 Stainless Steel	Type 304 or 316 Stainless Steel

- Types 303 and 304 stainless steels perform equally well in certain corrosive environments. Larger sizes are manufactured from Type 303.

Application:

Exterior environment, high level of corrosion resistance. Resistant to organic chemicals, many inorganic chemicals, mild atmospheric pollution and mild marine environments (not in direct contact with salt water).

Material Specifications

Type 316 Stainless Steel ¹			
Component Materials			
Anchor Body	Nut	Washer	Clip
Type 316 Stainless Steel	Type 316 Stainless Steel	Type 316 Stainless Steel	Type 316 Stainless Steel

- Type 316 stainless steel provides the greatest degree of corrosion resistance offered by Simpson Strong-Tie.

Application:

Exterior environment, high level of corrosion resistance. Resistant to chlorides, sulfuric acid compounds and direct contact with salt water.

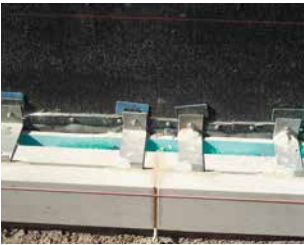

Tie-Wire Wedge Anchor

The Tie-Wire anchor is a wedge-style expansion anchor for use in normal-weight concrete or in concrete over metal deck. With a tri-segmented, dual-embossed clip, the Tie-Wire anchor is ideal for the installation of acoustic ceiling grid and is easily set with the claw of a hammer.

Features

- ¼" eyelet for easy threading of wire
- Sets with claw of hammer
- Tri-segmented clip – each segment adjusts independently to hole irregularities
- Dual embossments on each clip segment enable the clip to undercut into the concrete, increasing follow-up expansion
- Wedge-style expansion anchor for use in normal-weight concrete or concrete over metal deck

Material: Carbon steel

Coating: Zinc plated

Installation Instructions: See page 193.

NEW



Tie-Wire Wedge Anchor

Tie-Wire Anchor Product Data

Size (in.)	Model No.	Drill Bit Diameter (in.)	Eyelet Hole Size (in.)	Quantity	
				Box	Carton
¼" x 1½"	TW25112	¼	¼	100	500

Easy-Set Pin-Drive Expansion Anchor

The Easy-Set is a pin-drive expansion anchor for medium- and heavy-duty fastening applications into concrete and grout-filled block. Integrated nut and washer help keep track of parts.

Material: Carbon steel

Coating: Yellow zinc dichromate plated

Installation Instructions: See page 194.

EZAC Product Data

Size (in.)	Model No.	Thread Length (in.)	Quantity	
			Box	Carton
3/8 x 2 3/8	EZAC37238	1	50	250
3/8 x 3 1/2	EZAC37312	1 1/8	50	250
3/8 x 4 3/4	EZAC37434	1 1/2	50	200
1/2 x 2 3/4	EZAC50234	1	25	125
1/2 x 3 1/2	EZAC50312	1 1/8	25	125
1/2 x 4 3/4	EZAC50434	1 1/2	25	100
1/2 x 6	EZAC50600	2	25	100
5/8 x 4	EZAC62400	1 5/8	15	60
5/8 x 4 3/4	EZAC62434	1 5/8	15	60
5/8 x 6	EZAC62600	2	15	60



Easy-Set
(EZAC)

Easy-Set Anchor Installation Data

Easy-Set Diameter (in.)	3/8	1/2	5/8
Drill Bit Size (in.)	3/8	1/2	5/8
Min. Fixture Hole Size (in.)	7/16	9/16	11/16
Wrench Size (in.)	9/16	3/4	15/16

Sleeve-All® Sleeve Anchor

Sleeve-All® expanding anchors are pre-assembled, expanding sleeve anchors for use in all types of solid base materials. This anchor is available in acorn, hex, rod coupler, flat or round head style for a wide range of applications.

Codes: Factory Mutual 3017082, 3026805 and 3029959 ($\frac{3}{8}$ " – $\frac{1}{2}$ " diameter); Underwriters Laboratories File Ex3605 ($\frac{3}{8}$ " – $\frac{3}{4}$ " diameter); Multiple DOT listings; meets the requirements of Federal Specification A-A-1922A

Material: Carbon steel or stainless steel

Coating: Carbon steel anchors are zinc plated

Installation Instructions: See page 195.



Material Specifications

Anchor Component	Zinc-Plated Carbon Steel	304 Stainless Steel
Anchor Body	Material meets minimum 50,000 psi tensile	Type 304
Sleeve	SAE J403, Grade 1008 Cold-Rolled Steel	Type 304
Nut	Commercial Grade, meets requirements of ASTM A563 Grade A	Type 304
Washer	SAE J403, Grade 1008/1010 Cold-Rolled Steel	Type 304

Sleeve-All® Anchor Installation Data

Sleeve-All Diameter (in.)	$\frac{1}{4}$	$\frac{5}{16}$	$\frac{3}{8}$	$\frac{1}{2}$	$\frac{5}{8}$	$\frac{3}{4}$
Drill Bit Size (in.)	$\frac{1}{4}$	$\frac{5}{16}$	$\frac{3}{8}$	$\frac{1}{2}$	$\frac{5}{8}$	$\frac{3}{4}$
Wrench Size ¹ (in.)	$\frac{3}{8}$	$\frac{7}{16}$	$\frac{1}{2}$	$\frac{9}{16}$	$\frac{3}{4}$	$\frac{15}{16}$
Wrench Size for Coupler Nut (in.)			$\frac{1}{2}$	$\frac{5}{8}$	$\frac{3}{4}$	—

1. Applies to acorn- and hex-head configurations only.

Sleeve-All® Sleeve Anchor

Sleeve-All® Anchor Product Data — Zinc-Plated Carbon Steel

Size (in.)	Model No.	Head Style	Bolt Diameter – Threads per inch	Max. Fixture Thickness (in.)	Quantity			
					Box	Carton		
¼ x 1¾	SL25138A	Acorn Head	¾-24	¼	100	500		
¼ x 2¼	SL25214A			1½	100	500		
⅝ x 1½*	SL31112H	Hex Head	¼-20	¾	100	500		
⅝ x 2½	SL31212H			1⅞	50	250		
¾ x 1¾	SL37178H			¾	50	250		
¾ x 3	SL37300H			1½	50	200		
¾ x 4	SL37400H		⅝-18	2¼	50	200		
½ x 2¼*	SL50214H			½	50	200		
½ x 3	SL50300H			¾-16	¾	25	100	
½ x 4	SL50400H				1¾	25	100	
½ x 6	SL50600H				3¾	20	80	
⅝ x 2¼*	SL62214H				½	25	100	
⅝ x 3	SL62300H		½-13	¾	20	80		
⅝ x 4¼	SL62414H			1½	10	40		
⅝ x 6	SL62600H			3¼	10	40		
¾ x 2½*	SL75212H			½	10	40		
¾ x 4¼	SL75414H	⅝-11		7⁄8	10	40		
¾ x 6¼	SL75614H			2⅞	5	20		
¼ x 2	SL25200PF	Phillips Flat Head	¾-24	7⁄8	100	500		
¼ x 3	SL25300PF			1⅞	50	250		
⅝ x 2½	SL31212PF		¼-20	1⅞	50	250		
⅝ x 3½	SL31312PF			2⅞	50	250		
¾ x 2¾	SL37234PF			1¼	50	200		
¾ x 4	SL37400PF		⅝-18	2½	50	200		
¾ x 5	SL37500PF			3½	50	200		
¾ x 6	SL37600PF			4½	50	200		
¼ x 2¾	SL25234			Round Head	¾-24	7⁄8	50	250

*These models do not meet minimum embedment requirements for rated load values.

Sleeve-All® Anchor Product Data — Stainless Steel

Size (in.)	Model No.	Head Style	Bolt Diameter – Threads per inch	Max. Fixture Thickness (in.)	Quantity	
					Box	Carton
¾ x 1¾	SL37178HSS	Hex Head	⅝-18	¾	50	250
¾ x 3	SL37300HSS			1½	50	200
½ x 3	SL50300HSS		¾-16	¾	25	100
½ x 4	SL50400HSS			1¾	25	100

Sleeve-All® Anchor (with Rod Coupler) Product Data — Zinc-Plated Carbon Steel

Size (in.)	Model No.	Accepts Rod Diameter (in.)	Wrench Size (in.)	Quantity	
				Box	Carton
¾ x 1¾	SL37178C	¾	½	50	200
½ x 2¼	SL50214C	½	⅝	25	100
⅝ x 2¼	SL62214C	⅝	¾	20	80

Titen HD® Heavy-Duty Screw Anchor

The original high-strength screw anchor for use in cracked and uncracked concrete, as well as uncracked masonry. The Titen HD® offers low installation torque and outstanding performance. Designed and tested in dry, interior, non-corrosive environments or temporary outdoor applications, the Titen HD® demonstrates industry-leading performance even in seismic conditions.

Features

- Code listed under IBC/IRC in accordance with ICC-ES AC193 for cracked and uncracked concrete per ICC-ES ESR-2713
- Code listed under IBC/IRC in accordance with ICC-ES AC106 for masonry per ICC-ES ESR-1056
- Qualified for static and seismic loading conditions
- Thread design undercuts to efficiently transfer the load to the base material
- Standard fractional sizes
- Specialized heat-treating process creates tip hardness for better cutting without compromising the ductility
- No special drill bit required — designed to install using standard-sized ANSI tolerance drill bits
- Testing shows the Titen HD® installs in concrete with 50% less torque than competitor anchors
- Hex-washer head requires no separate washer and provides a clean installed appearance
- Removable — ideal for temporary anchoring (e.g., formwork, bracing) or applications where fixtures may need to be moved (reuse of the anchor to achieve listed load values is not recommended)

Codes: ICC-ES ESR-2713 (concrete); ICC-ES ESR-1056 (masonry); City of L.A. RR25741 (concrete), RR25560 (masonry); Florida FL-15730.6; FM 3017082, 3035761 and 3043442; Multiple DOT listings

Material: Carbon steel

Coating: Zinc plated or mechanically galvanized

Installation Instructions: See page 196.

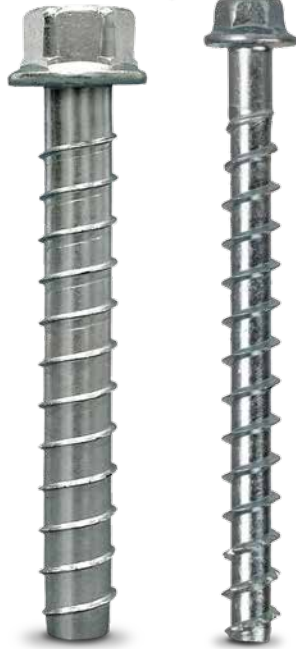

**Titen HD®
Screw Anchor**
U.S. Patents
5,674,035 and
6,623,228

**NEW 1/4" Titen HD®
Screw Anchor**
U.S. Patents
5,674,035 and
6,623,228



Serrated teeth on the tip of the Titen HD® screw anchor facilitate cutting and reduce installation torque.

Titen HD® Heavy-Duty Screw Anchor

Additional Installation Information

Titen HD® Diameter (in.)	Wrench Size (in.)	Recommended Fixture Hole Size (in.)	Min. Hole Depth Overdrill (in.)
¼	⅜	⅜ to 7/16	⅓
⅜	9/16	½ to 9/16	¼
½	¾	5/8 to 11/16	½
5/8	15/16	¾ to 13/16	½
¾	1 1/8	7/8 to 15/16	½

Titen HD® Anchor Product Data — Mechanically Galvanized

Size (in.)	Model No.	Drill Bit Diameter (in.)	Wrench Size (in.)	Quantity	
				Box	Carton
⅜ x 5	THD37500HMG	⅜	9/16	50	100
⅜ x 6	THD37600HMG			50	100
½ x 5	THD50500HMG	½	¾	20	80
½ x 6	THD50600HMG			20	80
½ x 6 ½	THD50612HMG			20	40
½ x 8	THD50800HMG			20	40
5/8 x 5	THDB62500HMG	5/8	15/16	10	40
5/8 x 6	THDB62600HMG			10	40
5/8 x 6 ½	THDB62612HMG			10	40
5/8 x 8	THDB62800HMG			10	20
¾ x 8 ½	THD75812HMG	¾	1 1/8	5	10
¾ x 10	THD75100HMG			5	10

Mechanical galvanizing meets ASTM B695, Class 65, Type 1. Intended for some pressure-treated wood sill plate applications. Not for use in other corrosive or outdoor environments. Visit www.strongtie.com/info for more corrosion information.

Titen HD® Heavy-Duty Screw Anchor

Titen HD® Anchor Product Data — Zinc Plated

Size (in.)	Model No.	Drill Bit Diameter (in.)	Wrench Size (in.)	Quantity	
				Box	Carton
1/4 x 1 7/8	THDB25178H	1/4	3/8	100	500
1/4 x 2 3/4	THDB25234H	1/4	3/8	50	250
1/4 x 3	THDB25300H	1/4	3/8	50	250
1/4 x 3 1/2	THDB25312H	1/4	3/8	50	250
1/4 x 4	THDB25400H	1/4	3/8	50	250
3/8 x 1 3/4	THD37134H*	3/8	9/16	50	250
3/8 x 2 1/2	THD37212H*	3/8	9/16	50	200
3/8 x 3	THD37300H	3/8	9/16	50	200
3/8 x 4	THD37400H	3/8	9/16	50	200
3/8 x 5	THD37500H	3/8	9/16	50	100
3/8 x 6	THD37600H	3/8	9/16	50	100
1/2 x 3	THD50300H	1/2	3/4	25	100
1/2 x 4	THD50400H	1/2	3/4	20	80
1/2 x 5	THD50500H	1/2	3/4	20	80
1/2 x 6	THD50600H	1/2	3/4	20	80
1/2 x 6 1/2	THD50612H	1/2	3/4	20	40
1/2 x 8	THD50800H	1/2	3/4	5	25
1/2 x 12	THD501200H	1/2	3/4	5	25
1/2 x 13	THD501300H	1/2	3/4	5	25
1/2 x 14	THD501400H	1/2	3/4	5	25
1/2 x 15	THD501500H	1/2	3/4	5	25
5/8 x 4	THDB62400H	5/8	15/16	10	40
5/8 x 5	THDB62500H	5/8	15/16	10	40
5/8 x 6	THDB62600H	5/8	15/16	10	40
5/8 x 6 1/2	THDB62612H	5/8	15/16	10	40
5/8 x 8	THDB62800H	5/8	15/16	10	20
3/4 x 4	THD75400H	3/4	1 1/8	10	40
3/4 x 5	THD7500H	3/4	1 1/8	5	20
3/4 x 6	THDT75600H	3/4	1 1/8	5	20
3/4 x 7	THD75700H	3/4	1 1/8	5	10
3/4 x 8 1/2	THD75812H	3/4	1 1/8	5	10
3/4 x 10	THD75100H	3/4	1 1/8	5	10

*These models do not meet minimum embedment depth requirements for strength design and require maximum installation torque of 25 ft.-lb. using a torque wrench, driver drill or cordless 1/4" impact driver with a maximum permitted torque rating of 100 ft.-lb.

NEW

Titen HD® Rod Coupler

The Titen HD® Rod Coupler is designed to be used in conjunction with a single or multi-story rod tie-down system. This anchor provides a fast and simple way to attach threaded rod to a concrete stem wall or thickened slab footing. Unlike adhesive anchors, the installation requires no special tools, cure time or secondary setting process; just drill a hole and drive the anchor.

Features

- The serrated cutting teeth and patented thread design enable the Titen HD Rod Coupler to be installed quickly and easily. Less installation time translates to lower installed cost
- The specialized heat treating process creates tip hardness to facilitate cutting while the body remains ductile
- No special setting tools are required. The Titen HD Rod Coupler installs with regular or hammer drill, ANSI size bits and standard sockets
- Compatible with threaded rods in $\frac{3}{8}$ " and $\frac{1}{2}$ " diameters

Material: Carbon steel

Coating: Zinc plated

Installation Instructions: See page 197.



**Titen HD®
Rod Coupler**
U.S. Patents
5,674,035 and
6,623,228

Titen HD® Rod Coupler Product Data

Size (in.)	Model No.	Accepts Rod Diameter (in.)	Drill Bit Diameter (in.)	Wrench Size (in.)	Quantity	
					Box	Carton
$\frac{3}{8}$ x $6\frac{3}{4}$	THD37634RC	$\frac{3}{8}$	$\frac{3}{8}$	$\frac{9}{16}$	50	100
$\frac{1}{2}$ x $9\frac{3}{4}$	THD50934RC	$\frac{1}{2}$	$\frac{1}{2}$	$\frac{3}{4}$	20	40

Titen® Concrete and Masonry Screw

Titen® screws are hardened screws for attaching all types of components to concrete and masonry. These fasteners are commonly used in applications such as attaching electrical boxes, light fixtures or window frames into concrete or masonry base materials.

Features

- Available in $\frac{3}{16}$ " and $\frac{1}{4}$ " diameter sizes
- Available in hex and Phillips flat-head designs in two colors
- Drill bit included with each box

Material: Carbon steel

Coating: Zinc plated with a baked-on ceramic coating

Codes: Florida FL-2355.1

Installation Instructions: See page 198.

Blue Titen® Product Data ($\frac{3}{16}$ " diameter)

Size (in.)	Model No. ¹	Drill Bit Diameter (in.)	Quantity	
			Box ²	Carton
$\frac{3}{16}$ X 1 $\frac{1}{4}$	TTN18114H	$\frac{5}{32}$	100	1600
$\frac{3}{16}$ X 1 $\frac{3}{4}$	TTN18134H			500
$\frac{3}{16}$ X 2 $\frac{1}{4}$	TTN18214H			500
$\frac{3}{16}$ X 2 $\frac{3}{4}$	TTN18234H			500
$\frac{3}{16}$ X 3 $\frac{1}{4}$	TTN18314H			400
$\frac{3}{16}$ X 3 $\frac{3}{4}$	TTN18334H			400
$\frac{3}{16}$ X 4	TTN18400H			400
$\frac{3}{16}$ X 1 $\frac{1}{4}$	TTN18114PF			$\frac{5}{32}$
$\frac{3}{16}$ X 1 $\frac{3}{4}$	TTN18134PF	500		
$\frac{3}{16}$ X 2 $\frac{1}{4}$	TTN18214PF	500		
$\frac{3}{16}$ X 2 $\frac{3}{4}$	TTN18234PF	500		
$\frac{3}{16}$ X 3 $\frac{1}{4}$	TTN18314PF	400		
$\frac{3}{16}$ X 3 $\frac{3}{4}$	TTN18334PF	400		
$\frac{3}{16}$ X 4	TTN18400PF	400		

1. H Suffix: Hex-Head. PF Suffix: Phillips Flat-Head.



Titen®
Hex-Head
Screw (H)

Titen®
Phillips Flat-Head
Screw (PF)

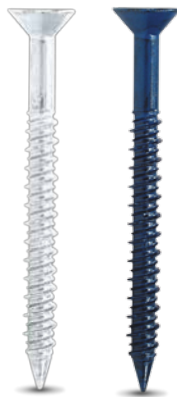

Titen® Phillips head
screw available in white
and standard blue

Titen® Concrete and Masonry Screw

Blue Titen® Product Data (1/4" diameter)

Size (in.)	Model No. ¹	Drill Bit Diameter (in.)	Quantity	
			Box	Carton
1/4 x 1 1/4	TTN25114H	3/16	100	1600
1/4 x 1 3/4	TTN25134H			500
1/4 x 2 1/4	TTN25214H			500
1/4 x 2 3/4	TTN25234H			500
1/4 x 3 1/4	TTN25314H			400
1/4 x 3 3/4	TTN25334H			400
1/4 x 4	TTN25400H			400
1/4 x 5	TTN25500H			400
1/4 x 6	TTN25600H			400
1/4 x 1 1/4	TTN25114PF	3/16	100	1600
1/4 x 1 3/4	TTN25134PF			500
1/4 x 2 1/4	TTN25214PF			500
1/4 x 2 3/4	TTN25234PF			500
1/4 x 3 1/4	TTN25314PF			400
1/4 x 3 3/4	TTN25334PF			400
1/4 x 4	TTN25400PF			400
1/4 x 5	TTN25500PF			400
1/4 x 6	TTN25600PF			400

1. H Suffix: Hex-Head. PF Suffix: Phillips Flat-Head.

White Titen® Product Data (Phillips Flat-Head)

Size (in.)	Model No.	Drill Bit Diameter (in.)	Quantity	
			Box	Carton
3/16 x 1 1/4	TTNW18114PF	5/32	100	1600
3/16 x 1 3/4	TTNW18134PF			500
3/16 x 2 1/4	TTNW18214PF			500
3/16 x 2 3/4	TTNW18234PF			500
3/16 x 3 1/4	TTNW18314PF			400
3/16 x 3 3/4	TTNW18334PF			400
1/4 x 1 1/4	TTNW25114PF	3/16	100	1600
1/4 x 1 3/4	TTNW25134PF			500
1/4 x 2 1/4	TTNW25214PF			500
1/4 x 2 3/4	TTNW25234PF			500
1/4 x 3 1/4	TTNW25314PF			400
1/4 x 3 3/4	TTNW25334PF			400

Titen® Stainless Steel Concrete and Masonry Screw

Stainless Steel Titen® screws are ideal for attaching various types of components to concrete and masonry, such as fastening electrical boxes or light fixtures. They offer the versatility of our standard Titen screws with enhanced corrosion protection. Available in hex and Phillips flat head.

Features

- Suitable for concrete, brick, grout-filled CMU and hollow-block applications
- Suitable for some preservative-treated wood applications
- Acceptable for exterior use
- Titen drill bits included in each box
- Available in lengths from 1¼" to 4"

Material: Type 410 stainless steel

Coating: Zinc plated with a protective overcoat

Installation Instructions:

See page 198.



Stainless-Steel Titen® Product Data

Size (in.)	Head Style	Model No.	Drill Bit Diameter (in.)	Quantity	
				Box	Carton
¼ x 1 ¼	Hex-Head	TTN25114HSS	⅜	100	1600
¼ x 1 ¾		TTN25134HSS		100	500
¼ x 2 ¼		TTN25214HSS		100	500
¼ x 2 ¾		TTN25234HSS		100	500
¼ x 3 ¼		TTN25314HSS		100	400
¼ x 3 ¾		TTN25334HSS		100	400
¼ x 4		TTN25400HSS		100	400
¼ x 1 ¼		Phillips Flat-Head		TTN25114PFSS	⅜
¼ x 1 ¾	TTN25134PFSS		100	500	
¼ x 2 ¼	TTN25214PFSS		100	500	
¼ x 2 ¾	TTN25234PFSS		100	500	
¼ x 3 ¼	TTN25314PFSS		100	400	
¼ x 3 ¾	TTN25334PFSS		100	400	
¼ x 4	TTN25400PFSS		100	400	

One drill bit is included in each box.

Titen® Screw – Installation Accessories

Titen® Screw – Installation Tool

The Simpson Strong-Tie® Titen® screw installation kit makes installation of Titen screws quick and easy. Accessories are compatible with a standard three-jaw style chuck, and the sockets have been designed to prevent over-torquing, which can lead to fastener failure. Comes packaged in a rugged plastic box ideal for storage of the installation kit and Titen screws.

Eight-piece kit includes:

- Drill bit holder
- 5/4" sleeve
- 1/4" and 5/16" hex sockets
- Phillips bit socket
- #2 and #3 Phillips bits
- Allen wrench

Titen® Installation Tool

Model No.	Quantity	
	Box	Carton
TTNT01	1	24



**Titen® Screw
Installation Kit**
(Model TTNT01)



Special hex adapter (included with the Titen Screw Installation Kit) allows the Titen Installation Tool to slide over the bit and lock in, ready to drive screws.

Titen® Screw – Installation Accessories

Titen® Screw – Drill Bits

The same bits that come included with boxes of Titen screws are also available separately. They work with the Titen Installation Tool as well as drills with a standard three-jaw style chuck.



Titen® Screw Drill Bit

Titen® Drill Bits

Size (in.)	Model No.	Use With		Quantity	
		Screw	Length	Box	Carton
5/32 x 3 1/2	MDB15312	3/16" diameter	To 1 3/4	12	48
5/32 x 4 1/2	MDB15412		To 3 1/4		
5/32 x 5 1/2	MDB15512		To 4		
3/16 x 3 1/2	MDB18312	1/4" diameter	To 1 3/4	12	48
3/16 x 4 1/2	MDB18412		To 3 1/4		
3/16 x 5 1/2	MDB18512		To 4		

Titen® Screw – SDS-Plus Drill Bit/Driver

This SDS-Plus shank bit works with the Titen Installation Tool to allow pre-drilling and installation of Titen screws using a rotohammer. Rotohammer must be in rotation-only mode before driving screws.



Titen® Screw Drill Bit/Driver

Titen® Drill Bit/Driver Product Data

Size (in.)	Model No.	For Screw Diameter (in.)	Drilling Depth (in.)	Overall Length (in.)
5/32 x 5	MDBP15500H	3/16	2 1/4	5
5/32 x 6	MDBP15600H		3 1/4	6
5/32 x 7	MDBP15700H		4 1/4	7
3/16 x 5	MDBP18500H	1/4	2 1/4	5
3/16 x 6	MDBP18600H		3 1/4	6
3/16 x 7	MDBP18700H		4 1/4	7

Titen drivers are sold individually.

Titen HD® Threaded Rod Hanger

The Titen HD® threaded rod hanger is a high-strength screw anchor designed to suspend threaded rod from concrete slabs and beams or concrete over metal in order to hang pipes, cable trays and HVAC equipment. The anchor offers low installation torque with no secondary setting, and has been tested to offer industry-leading performance in cracked and uncracked concrete – even in seismic loading conditions.

Features

- Thread design undercuts to efficiently transfer the load to the base material
- Serrated cutting teeth and patented thread design enable quick and easy installation
- Specialized heat-treating process creates tip hardness to facilitate cutting while the anchor body remains ductile
- Designed to install using a rotary hammer or hammer drill with standard ANSI drill bits – no special tools required
- Installs with standard-sized sockets
- The THD50234RH and THD37212RH are code listed for cracked and uncracked concrete applications under the 2012 and 2009 IBC/IRC, per ICC-ES ESR-2713

Codes: ICC-ES ESR-2713 (THD37212RH and THD50234RH); City of L.A. RR25741; Florida FL-15730.6; Factory Mutual 3031136 (THD50234RH and THD37218RH) and 3035761 (THD37212RH)

Material: Carbon steel

Coating: Zinc plated

Installation Instructions: See page 199.



THD50234RH
($\frac{3}{8}$ " dia. shank)

THD37212RH
($\frac{3}{8}$ " dia. shank)



THD37218RH
($\frac{1}{4}$ " dia. shank)

THD25112RH
($\frac{1}{4}$ " dia. shank)

U.S. Patents 5,674,035 and 6,623,228

Titen HD® Threaded Rod Hanger Product Data

Size (in.)	Model No.	Accepts Rod Diameter (in.)	Drill Bit Diameter (in.)	Wrench Size (in.)	Min. Embed. (in.)	Quantity	
						Box	Carton
$\frac{1}{4}$ x $1\frac{1}{2}$	THD25112RH	$\frac{1}{4}$	$\frac{1}{4}$	$\frac{3}{8}$	$1\frac{1}{2}$	100	500
$\frac{3}{8}$ x $2\frac{1}{8}$	THD37218RH	$\frac{3}{8}$	$\frac{1}{4}$	$\frac{1}{2}$	$2\frac{1}{8}$	50	250
$\frac{3}{8}$ x $2\frac{1}{2}$	THD37212RH	$\frac{3}{8}$	$\frac{3}{8}$	$\frac{1}{2}$	$2\frac{1}{2}$	50	200
$\frac{1}{2}$ x $2\frac{3}{4}$	THD50234RH	$\frac{1}{2}$	$\frac{3}{8}$	$1\frac{1}{16}$	$2\frac{3}{4}$	50	100



Wood Rod Hanger Threaded Rod Anchor System

The Simpson Strong-Tie® wood rod hanger is a one-piece fastening system for suspending ¼" or ⅜" threaded rod. Vertical rod hangers are designed to suspend threaded rod in overhead applications from wood members. Horizontal rod hangers are available for applications requiring installation into the side of joists, columns and overhead members. Both rod hangers provide attachment points for use in pipe hanging, fire protection, electrical conduit and cable-tray applications. Recommended for use in dry, interior, non-corrosive environments only.

Features

- Threaded anchors for rod-hanging applications in wood
- Suitable for installation horizontally or vertically in overhead applications
- No pre-drilling required
- Easily installed with a drill or screw gun
- Type-17 tip provides for fast starts
- UL/FM Listed

Material: Carbon steel

Coating: Zinc plated

Installation Instructions:

See page 200.



Vertical
Wood Rod Hanger
(RWV)



Horizontal
Wood Rod Hanger
(RWH)



Type-17 point
for use in wood

Wood Rod Hangers

Rod Diameter (in.)	Size	Model No.	Application	Point Style	Quantity	
					Box	Carton
¼	¼" x 2"	RWV25200	Vertical	Type 17	25	250
⅜	¼" x 1"	RWV37100				
⅜	¼" x 2"	RWV37200				
⅜	⅝" x 2½"	RWV37212				
¼	¼" x 1"	RWH25100	Horizontal	Type 17	25	250
⅜	¼" x 2"	RWH37200				
⅜	⅝" x 2½"	RWH37212				



Nut Driver
RND62

Nut Driver

Model No.	Description	Quantity	
		Box	Carton
RND62	Nut Driver	1 blister	10

Wood-Form Insert

Multi-thread, cast-in-place wood-form and metal-deck inserts for cracked and uncracked concrete maximize jobsite efficiency and reduce inventory commitment. Also available in metal-roof-deck insert version, offering a low-profile design that does not interfere with roofing material.

Features

- Code listed under the IBC/IRC in accordance with AC408 for cracked and uncracked concrete applications, per ICC-ES ESR-3707
- Multi-thread design allows insert to accept multiple rod diameters
- Blue plastic ring acts as an insert locator when forms are removed
- Plastic ring creates a countersunk recess to keep internal threads clean from concrete residue
- Nails snap off with a hammer strike after the forms are removed

Material: Carbon steel

Coating: Yellow zinc dichromate coating

Codes: ICC-ES ESR-3707; Factory Mutual 3024378 (see pipe size limit tables); Underwriters Laboratories File Ex3605 (see pipe size limit tables)

Installation Instructions: See page 201.



Patented multi-thread design allows one product to handle up to three rod diameters.

Product Data

Hanger Type	For Rod Diameter (in.)	Model No.	Carton Quantity
Wood-Form Insert	1/4, 3/8, 1/2	BBWF2550	200
	3/8, 1/2, 5/8	BBWF3762	150
	5/8, 3/4	BBWF6275	150



Blue Banger Hanger® Cast-In-Place, Internally Threaded Insert

Metal-Deck Insert

Features

- Code listed under the IBC/IRC in accordance with AC446 for cracked and uncracked concrete applications, per ICC-ES ESR-3707
- Multi-thread design allows insert to accept multiple rod diameters
- Compression spring keeps insert perpendicular to deck, even if bumped or stepped on after installation
- 3" plastic sleeve keeps internal threads clean and provides guidance to align threaded rod with the internal threads
- Extended sleeve length allows easy location of insert even with fireproofing on the underside of the deck
- Installed height of 2" allows insert to be used on top of or between deck flutes

Material: Carbon steel

Coating: Yellow zinc dichromate coating

Codes: ICC-ES ESR-3707; Factory Mutual 3024378 (see pipe size limit tables); Underwriters Laboratories File Ex3605 (see pipe size limit tables)

Installation Instructions: See page 201.



Patented multi-thread design allows one product to handle up to three rod diameters.

Product Data

Hanger Type	For Rod Diameter (in.)	Deck Hole Diameter (in.)	Model No.	Carton Quantity
Metal-Deck Insert	¼, ⅜, ½	1⅜ - 7⁄8	BBMD2550	100
	⅝, ½, 5⁄8	1⅞ - 1⅜	BBMD3762	50
	5⁄8, ¾	1⅞ - 1¼	BBMD6275	50



Metal-Roof-Deck Insert

Features

- Multi-thread design: The insert accepts three different rod diameters
- Low-profile design does not interfere with roofing material
- Positive attachment to the roof deck prevents spinning and keeps the hanger in position
- Pre-staked, self-drilling screws allow quick installation

Material: Carbon steel

Coating: Yellow zinc dichromate coating

Installation Instructions: See page 202.



Patented multi-thread design allows one product to handle up to three rod diameters.

Product Data

Hanger Type	For Rod Diameter (in.)	Deck Hole Diameter (in.)	Model No.	Carton Quantity
Roof-Deck Insert	1/4, 3/8, 1/2	7/8	BBRD2550	50

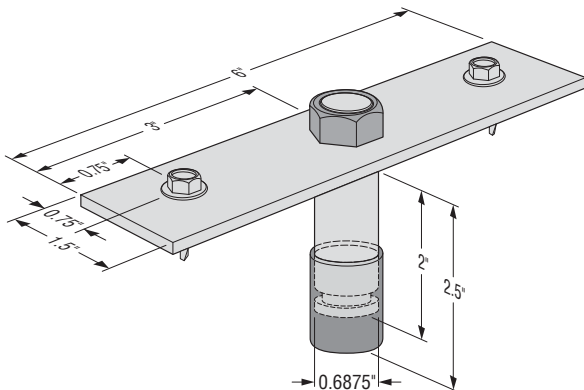

Drop-In Internally Threaded Anchor (DIAB)

Expansion shell anchors for use in solid base materials



Simpson Strong-Tie introduces a new, redesigned Drop-In Anchor (DIAB) that provides easier installation into base materials. Improved geometry in the preassembled expansion plug improves setting capability so the anchor installs with 40% fewer hammer strikes than previous versions. These displacement-controlled expansion anchors are easily set by driving the plug toward the bottom of the anchor using either the hand or power setting tools. DIAB anchors feature a positive-set marking indicator at the top of the anchor — helping you see more clearly when proper installation has taken place.

Use a Simpson Strong-Tie fixed-depth stop bit to take the guesswork out of drilling to the correct depth. The fluted design of the tip draws debris away from the hole during drilling, allowing for a cleaner installation.

Key Features

- New design offers easier installation than previous drop-in anchor design – sets with 40% fewer hammer hits
- Positive-set marking system indicates when anchor is properly set
- Lipped drop-in version available for flush installation
- Hand- and power-setting tools available for fast, easy and economical installation
- Fixed-depth stop bit helps you drill to the correct depth every time

Material: Carbon steel

Coating: Zinc plated

Installation Instructions: See page 203.



Drop-In



Lipped Drop-In



Drop-In Internally Threaded Anchor (DIAB)



Anchor being set with hand setting tool.



Anchor being set with SDS setting tool.



Positive set indicator.

Drop-In Internally Threaded Anchor (DIAB)

Drop-In Anchor

Rod Size (in.)	Model No.	Drill Bit Diameter (in.)	Bolt Threads (per inch)	Body Length (in.)	Thread Length (in.)	Quantity	
						Box	Carton
1/4	DIAB25	3/8	20	1	3/8	100	500
3/8	DIAB37	1/2	16	1 1/16	5/8	50	250
1/2	DIAB50	5/8	13	2	3/4	50	200
5/8	DIAB62	7/8	11	2 1/2	1	25	100
3/4	DIAB75	1	10	3 1/8	1 1/4	20	80



Drop-In

Lipped Drop-In Anchor

Rod Size (in.)	Model No.	Drill Bit Diameter (in.)	Bolt Threads (per inch)	Body Length (in.)	Thread Length (in.)	Quantity	
						Box	Carton
1/4	DIABL25	3/8	20	1	3/8	100	500
3/8	DIABL37	1/2	16	1 1/16	5/8	50	250
1/2	DIABL50	5/8	13	2	3/4	50	200



Lipped Drop-In

Drop-In Internally Threaded Anchor (DIAB)

Drop-In Anchor Hand Setting Tool

Model No.	For Use With	Box Quantity
DIABST25	DIAB25, DIABL25	10
DIABST37	DIAB37, DIABL37	10
DIABST50	DIAB50, DIABL50	10
DIABST62	DIAB62	5
DIABST75	DIAB75	5

1. Setting tools sold separately, Tools may be ordered by the piece.



Hand Setting Tool

Drop-In Anchor Power Setting Tool

Model No.	For Use With	Box Quantity
DIABST25-SDS	DIAB25, DIABL25	10
DIABST37-SDS	DIAB37, DIABL37	10
DIABST50-SDS	DIAB50, DIABL50	10



Power Setting Tool

Fixed-Depth Drill Bits

Model No	Drill Bit Diameter (in.)	Drill Depth (in.)	For Use With
MDPL037DIA	$\frac{3}{8}$	$1\frac{1}{16}$	DIAB25, DIABL25
MDPL050DIA	$\frac{1}{2}$	$1\frac{11}{16}$	DIAB37, DIABL37
MDPL062DIA	$\frac{5}{8}$	$2\frac{1}{16}$	DIAB50, DIABL50



Fixed-Depth Drill Bit

Drop-In Internally Threaded Anchor (DIA)

Drop-in anchors are internally threaded drop-in expansion anchors for use in flush-mount applications in solid base materials. Available in stainless steel (DIA), short (DIAS) or coil-thread (DIAC) versions. Minimum thread engagement should be equal to the nominal diameter of the threaded insert.

Features

- Lipped edge (DIAS) eliminates need for precisely drilled hole depth
- Available in coil-thread version for ½" and ¾" coil-threaded rod
- Short length (DIAS) enables shallow embedment to help avoid drilling into rebar or pre-stressed/post-tensioned cables
- Short Drop-In anchors include a setting tool compatible with the anchor to ensure consistent installation

Material: Carbon and stainless steel

Coating: Carbon steel; zinc plated

Codes: Drop-in: DOT; Factory Mutual 3017082; Underwriters Laboratories File Ex3605. Meets requirements of Federal Specifications A-A-55614, Type I.

Short drop-in: Factory Mutual 3017082 and Underwriters Laboratories File Ex3605.

Installation Instructions: See page 205.



**Drop-In
Stainless Steel**



Short Drop-In



**Coil-Thread
Drop-In**

Drop-In Internally Threaded Anchor (DIA)

Drop-In Anchor Product Data — Stainless Steel

Rod Size (in.)	Type 303/304 Stainless Model No.	Type 316 Stainless Model No.	Drill Bit Diameter (in.)	Bolt Threads (per in.)	Body Length (in.)	Thread Length (in.)	Quantity	
							Box	Carton
¼	DIA25SS	DIA256SS	⅜	20	1	⅜	100	500
⅜	DIA37SS	DIA376SS	½	16	1⅞	⅝	50	250
½	DIA50SS	DIA506SS	⅝	13	2	¾	50	200
⅝	DIA62SS	—	⅞	11	2½	1	25	100
¾	DIA75SS	—	1	10	3⅜	1¼	20	80

Short Drop-In Anchor Product Data

Rod Size (in.)	Model No.	Drill Bit Diameter (in.)	Bolt Threads (per in.)	Body Length (in.)	Thread Length (in.)	Quantity	
						Box	Carton
⅜	DIA37S ¹	½	16	¾	¼	100	500
½	DIA50S ¹	⅝	13	1	⅝	50	200

1. A dedicated setting tool is included with each box of DIA37S and DIA50S.

Coil-Thread Drop-In Anchor Product Data

Rod Size (in.)	Carbon Steel Model No.	Drill Bit Diameter (in.)	Bolt Threads (per in.)	Body Length (in.)	Thread Length (in.)	Quantity	
						Box	Carton
½	DIA50C ¹	⅝	6	2	¾	50	200
¾	DIA75C ¹	1	5	3⅜	1¼	20	80

1. DIA50C and DIA75C accept ½" and ¾" coil-thread rod, respectively.

Drop-In Internally Threaded Anchor (DIA)

Drop-In Anchor Setting Tool Product Data

Model No.	For Use With	Box Quantity
DIAS25	DIA25SS, DIA256SS	10
DIAS37	DIA37SS, DIA376SS	10
DIAS50	DIA50SS, DIA506SS, DIA50C	10
DIAS62	DIA62SS	5
DIAS75	DIA75SS, DIA75C	5

1. Setting tools sold separately except for DIA37S and DIA50S.
2. Setting tools for use with carbon and stainless-steel drop-in anchors.
3. Setting tools may be ordered by the piece.



Drop-In Anchor Setting Tool

Drop-In Anchor (DIA) Power Setting Tool

Model No.	For Use With	Box Quantity
DIAS37S-SDS	DIA37S	10
DIAS50S-SDS	DIA50S	10

Also sold by the piece



Power Setting Tool

Fixed-Depth Drill Bits

Model No.	Drill Bit Diameter (in.)	Drop-In Anchor (in.)	Drill Depth (in.)
MDPL037DIA	$\frac{3}{8}$	$\frac{1}{4}$	$1\frac{1}{16}$
MDPL050DIA	$\frac{1}{2}$	$\frac{3}{8}$	$1\frac{11}{16}$
MDPL062DIA	$\frac{1}{2}$	$\frac{1}{2}$	$2\frac{1}{16}$
MDPL050DIAS	$\frac{5}{8}$	$\frac{3}{8}$	$1\frac{3}{16}$
MDPL062DIAS	$\frac{5}{8}$	$\frac{1}{2}$	$1\frac{1}{4}$



Fixed-Depth Drill Bit

Hollow Drop-In Internally Threaded Anchor

The Simpson Strong-Tie® Hollow Drop-In Anchor (HDIA) is an internally threaded, flush-mount expansion anchor for use in hollow materials such as CMU and hollow-core plank, as well as in solid base materials such as brick, normal-weight and lightweight concrete.

Features

- Suitable for suspending conduit, cable trays, pipe supports, fire sprinklers and suspended lighting into concrete
- Expansion design allows HDIA to anchor into CMU, hollow-core plank, brick, normal-weight concrete and lightweight concrete
- Internally threaded anchor allows for easy bolt removal

Material: Die-cast Zamac 3 alloy shell with carbon-steel cone or 304 stainless-steel cone

Codes: Factory Mutual 3053987 (3/8"–1/2" diameter) Underwriters Laboratories File Ex3605 (3/8"–1/2" diameter)

Installation Instructions:

See pages 206–207.



Hollow Drop-In Anchor

Size	Model No.	Drill Bit Diameter (in.)	Threads (per in.)	Overall Anchor Length (in.)	Quantity	
					Package Quantity	Carton Quantity
1/4"	HDIA25	3/8	20	3/4	100	1600
1/4"	HDIA25SS	3/8	20	3/4	100	1600
5/16"	HDIA31	5/8	18	1 1/4	50	200
3/8"	HDIA37	5/8	16	1 1/4	50	200
3/8"	HDIA37SS	5/8	16	1 1/4	50	200
1/2"	HDIA50	3/4	13	1 3/4	50	250
5/8"	HDIA62	1	11	2	25	125

Hollow Drop-In Internally Threaded Anchor

Setting Tool for Hollow Materials*

Size	Model No.	For Use With	Quantity	
			Package Quantity	Carton Quantity
1/4"	HDIASTH25	HDIA25, HDIA25SS	—	25
5/16"	HDIASTH31	HDIA31	—	25
3/8"	HDIASTH37	HDIA37, HDIA37SS	—	25
1/2"	HDIASTH50	HDIA50	—	25
5/8"	HDIASTH62	HDIA62	—	10



Setting Tool for Solid Materials*

Size	Model No.	For Use With	Quantity	
			Package Quantity	Carton Quantity
1/4"	HDIASTS25	HDIA25, HDIA25SS	25	125
5/16" – 3/8"	HDIASTS31 – 37	HDIA31, HDIA37, HDIA37SS	10	50
1/2"	HDIASTS50	HDIA50	10	50
5/8"	HDIASTS62	HDIA62	5	20

*Tools sold separately. Tools may be ordered by the piece.

LSES Lag Screw Expansion Shield

The Lag Screw Expansion Shield is a die-cast zinc alloy expansion shield for anchoring lag screws in a variety of base materials, including concrete, concrete block, brick and mortar joints. Radial ribs provide additional holding power in softer material.

Material: Die-cast Zamac 3 alloy

Installation Instructions: See page 208.



LSES

LSES Product Data

Size (in.)	Model No.	Drill Bit Diameter (in.)	Embed. Depth (in.)	Quantity	
				Box	Carton
¼ Short	LSES25S	½	1	100	500
⅝ Short	LSES31S	½	1¼	100	500
¾ Short	LSES37S	⅝	1¾	50	250
½ Short	LSES50S	¾	2	25	125
¼ Long	LSES25L	½	1½	50	250
⅝ Long	LSES31L	½	1¾	50	250
¾ Long	LSES37L	⅝	2½	50	200
½ Long	LSES50L	¾	3	25	100

ESA Expansion Screw Anchor

The ESA was the original internally threaded mechanical anchor design. The malleable lead shield allows for secure mounting.

Material: Cone: Die-cast Zamac 3 alloy;
expander shield: 3–5% antimonial lead

Code: Meets Federal Specifications A-A-1922A,
Type 1, except ESA50.

Installation Instructions: See page 209.



ESA

ESA Product Data

Internal Thread Size (diameter - threads per inch)	Model No.	Drill Bit Diameter (in.)	Embed. Depth (in.)	Quantity	
				Box	Carton
¼ - 20	ESA25	½	⅞	100	500
⅜ - 16	ESA37	¾	1 ¼	50	200
½ - 13	ESA50	⅞	1 ½	50	200

Piloted Setting Punch Product Data

Model No.	For Use With	Box Qty.
PSP25	ESA25	10
PSP37	ESA37	10
PSP50	ESA50	10



Piloted Setting Punch

Zinc Nailon™ Pin Drive Anchors

Zinc Nailon™ anchors are low-cost, easy-to-install anchors for applications under static loads.

Features

- Available with carbon and stainless-steel pins
- Pin and head configuration designed to make anchor tamper-resistant

Materials

Body – Die-cast Zamac 3 alloy

Pin – Carbon steel; Type 304 stainless steel

Code: Meets Federal Specification

A-A-1925A, Type 1

Installation Instructions: See page 210.



Zinc Nailon™
Anchor
(Mushroom)

Zinc Nailon™ Product Data

Size (in.)	Carbon Steel Pin Model No.	Stainless Steel Pin Model No.	Quantity		
			Box	Carton	Bulk
3/16 x 7/8	ZN18078	—	100	1,600	3,000
1/4 x 3/4	ZN25034	ZN25034SS	100	500	2,000
1/4 x 1	ZN25100	ZN25100SS	100	500	1,500
1/4 x 1 1/4	ZN25114	ZN25114SS	100	500	1,500
1/4 x 1 1/2	ZN25112	ZN25112SS	100	500	1,000
1/4 x 2	ZN25200	ZN25200SS	100	400	1,000
1/4 x 2 1/2	ZN25212	ZN25212SS	100	400	1,000
1/4 x 3	ZN25300	ZN25300SS	100	400	1,000

Crimp Drive® Anchor

The Crimp anchor is an easy-to-install expansion anchor for use in concrete and grout-filled block. The pre-formed curvature along the shaft creates an expansion mechanism that secures the anchor in place and eliminates the need for a secondary tightening procedure. This speeds up anchor installation and reduces the overall cost.

Five crimp anchor head styles are available to handle different applications that include fastening wood or light-gauge steel, attaching concrete formwork, hanging overhead support for sprinkler pipes or suspended ceiling panels.

Material: Carbon steel

Coating: Zinc plated and mechanically galvanized

Codes: Factory Mutual 3031136 for the 3/8" Rod Coupler

Head Styles: Mushroom, rod coupler, countersunk, tie-wire and duplex

Installation Instructions: See page 211.



Mushroom
Head



Rod
Coupler

NEW



Countersunk
Head



Tie-Wire



Duplex

Crimp Drive® Anchor Product Data

Size (in.)	Model No.	Head Style/Finish	Drill Bit Diameter (in.)	Min. Fixture Hole Size	Min. Embed. (in.)	Quantity			
						Package Quantity	Carton Quantity		
3/16 x 1 1/4	CD18114M	Mushroom Head/ Zinc Plated	3/16	1/4	7/8	100	1600		
3/16 x 2	CD18200M				1 1/4	100	500		
3/16 x 2 1/2	CD18212M				1 1/4	100	500		
3/16 x 3	CD18300M				1 1/4	100	500		
3/16 x 3 1/2	CD18312M				1 1/4	100	500		
3/16 x 4	CD18400M				1 1/4	100	500		
1/4 x 1	CD25100M		1/4	5/16	7/8	100	1,600		
1/4 x 1 1/4	CD25114M				7/8	100	1,600		
1/4 x 1 1/2	CD25112M				1 1/4	100	1,600		
1/4 x 2	CD25200M				1 1/4	100	500		
1/4 x 2 1/2	CD25212M				1 1/4	100	500		
1/4 x 3	CD25300M				1 1/4	100	500		
1/4 x 3 1/2	CD25312M				1 1/4	100	500		
1/4 x 4	CD25400M				1 1/4	100	500		
3/8 x 2	CD37200M				3/8	7/16	1 3/4	25	125
3/8 x 3	CD37300M						1 3/4	25	125
1/4 x 3	CD25300MG		Mushroom Head/ Mechanically Galvanized	1/4	5/16	1 1/4	100	500	
1/4" Rod Coupler	CD25114RC		Rod Coupler/ Zinc Plated	3/16	N/A	1 1/4	100	500	
3/8" Rod Coupler	CD37112RC	1/4		N/A	1 1/2	50	250		
3/16 x 2 1/2	CD18212C	Countersunk Head/ Zinc Plated	3/16	1/4	1 1/4	100	500		
3/16 x 3	CD18300C				1 1/4	100	500		
3/16 x 4	CD18400C				1 1/4	100	500		
1/4 x 1 1/2	CD25112C		1/4	5/16	1 1/4	100	500		
1/4 x 2	CD25200C				1 1/4	100	500		
1/4 x 2 1/2	CD25212C				1 1/4	100	500		
1/4 x 3	CD25300C				1 1/4	100	500		
1/4 x 3 1/2	CD25312C				1 1/4	100	400		
1/4 x 4	CD25400C				1 1/4	100	400		
1/4 x 3	CD25300CMG				Countersunk Head/ Mechanically Galvanized ¹	1/4	5/16	1 1/4	100
1/4 x 4	CD25400CMG	1 1/4	100	400					
1/4" Tie Wire	CD25118T	Tie Wire/Zinc Plated	1/4	N/A	1 1/8	100	500		
1/4" Duplex	CD25234D	Duplex Head/ Zinc Plated	1/4	5/16	1 1/4	100	500		

NEW

1. Mechanical galvanizing meets ASTM B695, Class 55, Type 1. Intended for some pressure-treated wood sill plate applications. Not for use in other corrosive or outdoor environments. See www.strongtie.com for details.

CSD/DSD Split-Drive Anchors

The Split-Drive anchor is a one-piece expansion anchor that can be installed in concrete, grout-filled block and stone. As the anchor is driven in, the split-type expansion mechanism on the working end compresses and exerts force against the walls of the hole.

Features

- Available in countersunk (CSD) and duplex-head (DSD) styles
- DSD anchor can be removed with a claw hammer for temporary applications

Material: Carbon steel

Coating: Zinc plated; mechanically galvanized

Installation Instructions: See page 212.



DSD
(Duplex)

CSD
(Countersunk)

CSD/DSD Product Data

Size (in.)	Model No.	Head Style/Finish	Drill Bit Diameter (in.)	Quantity	
				Box	Carton
¼ x 1½	CSD25112	Countersunk Head – Zinc Plated	¼	100	500
¼ x 2	CSD25200			100	500
¼ x 2½	CSD25212			100	500
¼ x 3	CSD25300			100	400
¼ x 3½	CSD25312			100	400
¼ x 4	CSD25400			100	400
¼ x 3	CSD25300MG	Countersunk Head – Mechanically Galvanized ¹	¼	100	400
¼ x 4	CSD25400MG			100	400
¼ x 3	DSD25300	Duplex Head – Zinc Plated	¼	100	400

1. Mechanical galvanizing meets ASTM B695, Class 55, Type 1. Intended for some preservative-treated wood sill plate applications. Not for use in other corrosive or outdoor environments. See www.strongtie.com for details.

Sure Wall Drywall Anchor

Sure Wall anchors are self-drilling drywall anchors and provide excellent holding value and greater capacity than screws alone. This anchor cuts threads into drywall, greatly increasing the bearing surface and strength of the fastening.

Features

- Self-drilling—may be installed in gypsum board drywall with only a screwdriver
- Easy to remove and reinstall

Material: Die-cast zinc or reinforced nylon

Installation Instructions:

See page 213.



Sure Wall
Nylon



Sure Wall
Zinc

Sure Wall Product Data — Packaged with Screws

Screw Size	Model No.	Style	Quantity		Applications
			Box	Carton	
#6 x 7/8"	SWN06S-R100	Nylon	100	500	3/8", 1/2" drywall, ceiling tile
#8 x 1 1/4"	SWN08LS-R100	Nylon	100	500	3/8", 1/2" drywall, ceiling tile
#6 x 7/8"	SWZ06S-R100	Zinc	100	500	3/8", 1/2" drywall, ceiling tile, plaster, pegboard
#8 x 1 1/4"	SWZ08LS-R100	Zinc	100	500	3/8", 1/2", 5/8" drywall, plaster

Sure Wall Product Data — Packaged Without Screws

Screw Size	Model No.	Style	Quantity		Applications
			Box	Carton	
#6 x 7/8"	SWN06-R100	Nylon	100	500	3/8", 1/2" drywall, ceiling tile
#8 x 1 1/4"	SWN08L-R100	Nylon	100	500	3/8", 1/2" drywall, ceiling tile
#6 x 1"	SWZ06-R100	Zinc	100	500	3/8", 1/2" drywall, ceiling tile, plaster, pegboard
#8 x 1 1/4"	SWZ08L-R100	Zinc	100	500	3/8", 1/2", 5/8" drywall, plaster

Direct Fastening Solutions



On the jobsite, time is money. That's why Simpson Strong-Tie offers a full range of gas- and powder-actuated tools and fasteners designed to maximize jobsite productivity and operator comfort in most applications.

Single-shot and fully automatic tool options efficiently drive our line of fasteners into concrete and steel. We also offer free online Powder-Actuated Tool certification at www.strongtie.com/pat.



GCN-MEPMAG Gas-Actuated Concrete Nailer

The GCN-MEPMAG and GCN-MEP gas-actuated concrete nailers are portable fastener tools for attaching light-duty fixtures to concrete, steel, concrete block (CMU), lightweight concrete over metal deck, and cold-formed steel. As a magazine tool, GCN-MEPMAG is ideal for attaching drywall track, furring strips, hat track and angle track using GDP and GDPS collated pins.

GCN-MEPMAG offers you the flexibility of having two tools in one convenient package — a magazine tool and a single-shot tool, since the magazine is easily removed without additional assembly tools. As a single-shot tool, the GCN-MEP is great for attaching mechanical, electrical and plumbing fixtures with pre-assembled pins/accessories such as washer pins, ceiling clips, tophats and threaded studs. The pre-assembled pins for the single-shot tool use 0.300"-headed fasteners with 0.125"-diameter shanks for stronger fastening performance.

Both the single-shot and magazine tool offer portability without the need for cords or hoses, and are actuated with GFC34 gas fuel cells.

Features

- Power to drive 0.125"-diameter pins
- Flexibility to drive ½" to 1½" pins
- Flexibility to drive 0.250" and 0.300" dia. headed pins
- Pin-depth adjustment dial
- Battery charge indicator light
- Comfortable "sure-grip" rubber handle and ladder hook
- Easy start-up procedure: Insert fuel cell, insert battery, load pins, and begin use
- FREE tool first-aid repair program (see back cover of operators manual)



GCN-MEPMAG

Specifications

- Tool dimensions:
 - Length 12.5" (317.5 mm), 17" (432.8 mm)
 - Tool weight: 6.6 lb. (3 kg), 8.3 lb. (3.7 kg) with magazine
 - Height 15.3" (389 mm)
- Compatible fasteners:
 - Length: ½" (12.7 mm) to 1½" (38 mm)
 - Head diameter: 0.250" and 0.300"
 - Shank diameter: 0.106" to 0.125"
- Average number of shots per fuel cell: 1,200
- Average cyclic firing rate: 2 shots per second
- Average battery charge time (6V NiMH): 2 hours
- Operation temperature range: 20°–120°F (–6°–49°C)
- Magazine capacity: 42
- Maximum fastenings before reloading: 40

The magazine is designed to retain two pins during use to prevent the tool from discharging without a fastener (which can damage the tool and possibly cause injury). The tool will resume normal operation when additional pins are loaded.

GCN-MEPMAG Gas-Actuated Concrete Nailer**Minimum Cleaning Required**

The GCN-MEP has a very efficient ignition system that provides complete fuel combustion. This results in a cleaner operating tool, which, in turn, results in more tool energy and higher productivity. To maintain maximum level of productivity, periodic cleaning is recommended.

- Only requires cleaning every 20,000 shots
- Easy access to the air filter and piston chamber

The GCN-MEP MAG gas-actuated concrete nailer is ideal for fastening:

- Drywall track
- Lath wire for stucco
- Water-proofing membrane
- Furring strips



MEP-MAG1KT
sold separately



GCN-MEPKT or GCN-MEPMAGKT
(with magazine)



Gas-Actuated Concrete Nailing

GDP Pins

GDP concrete pins are designed to work with the GCN-MEPMAG gas-actuated concrete nailer as well as with many major-brand gas-actuated concrete-nailer tools. The patented 10-fastener strip is designed with break-away plastic. The pins are designed for use in A36 and A572 steel, concrete, CMU block and sand-lightweight concrete over metal deck.



GDP

U.S. Patent 605,016

Codes: ICC-ES ESR-2811; Florida FL-15730; City of L.A. RR25837

0.106"-Diameter Shank Drive Pins

Model No.	Length (in.)	Qty. Pins / Pack +1 Fuel Cell	Packs/ Carton	Compatible with These Tools
GDP-50KT	½	1,000	5	Simpson Strong-Tie GCN-MEPMAG Others: TF1100, C3, TF1200
GDP-62KT	⅝	1,000	5	
GDP-75KT	¾	1,000	5	
GDP-100KT	1	1,000	5	
GDP-125KT	1¼	1,000	5	
GDP-150KT	1½	1,000	5	

GDPS Pins

The GDPS pins are also designed to work in the GCN-MEPMAG gas-actuated nailer tool for installation into steel and concrete. The step-shank pin, with a smaller-diameter tip, facilitates easier penetration, while the larger-diameter upper shank provides more shear resistance and successful installation.



GDPS

0.118"/0.102"-Diameter Stepped-Shank Drive Pins

Model No.	Length (in.)	Qty. Pins / Pack + 1 fuel cell	Packs/ Carton	Compatible Tools	
				Simpson Strong-Tie	Others
GDPS-50KT	½	1,000	5	GCN-MEPMAG	TF1100, C3, TF1200
GDPS-62KT	⅝	1,000	5		
GDPS-75KT	¾	1,000	5		

Gas-Actuated Concrete Nailing

Spiral Knurl Gas Pins

GDPSK gas pins are designed for attaching plywood and OSB to cold-formed-steel studs. The spiral knurl provides a positive lock and resists back-out. Installed with the GCN-MEPMAG, the GDPSK-138 gas pin provides faster installation and setup times, which contributes to lower labor costs. The hardened pins quickly and cleanly pierce the cold-formed steel and leave the pin head flush with the wood fixture. The 1 $\frac{3}{8}$ " length pin can be used for $\frac{1}{2}$ "– $\frac{3}{4}$ " thick plywood, and 14–22 gauge steel.



GDPSK

Spiral Knurl Gas Pins

Model No.	Length (in.)	Qty. Pins / Pack + 1 fuel cell	Packs/ Carton	Compatible with These Tools
GDPSK-138KT	1 $\frac{3}{8}$	1,000	5	Simpson Strong-Tie: GCN-MEPMAG Others: TF1100, C3

GWL-100 Lathing Washer and GMR-2 Magnetic Ring

The GWL-100 lathing washer is used with the GCN-MEPMAG tool and attaches lath to the wall surface for overlaying scratch coats, brown coats and stucco. The washers are held onto the nose of the tool with the new GMR-2 magnetic ring and are attached to the substrate (including concrete and CMU) with GDP pins, which fasten through the washer. No extra tools are needed to install the magnetic ring to the nosepiece of the tool.



GWL-100

Lathing Washer and Magnetic Ring

Model No.	Description	Pack Quantity	Carton Quantity
GWL-100	Lathing Washer, 1" Diameter	1,000	5,000
GMR-2	Magnetic Ring for GCN-MEP	10	900



GMR-2

Lathing Washer and Magnetic Rings are sold separately.

Gas-Actuated Concrete Nailing

Fuel Cell

The GFC34 fuel cell is designed to operate with the GCN-MEPMAG and GCN-MEP, and with many major-brand gas-actuated concrete-nailer tools. The fuel cell provides 1,200 shots and can operate at temperatures between 20° and 120°F (-6°–49°C). The fuel cells are offered individually or in a two-per-pack clamshell. Additionally, one fuel cell is included with each pack of 1,000 pins.



GFC Fuel Cell

Gas Fuel Cells for the GCN-MEP

Model No.	Description	Pack Quantity	Packs/ Carton	Compatible with These Tools
GFC34	34-gram fuel cells	12	—	Simpson Strong-Tie® GCN-MEP and GCN-MEPMAG Others:
GFC34-RC2	(2) 34-gram fuel cells	2	6	TrakFast® TF1100, TF1200, Trak-It® C3

GCN-MEP Gas-Actuated Pins and Assemblies for Mechanical, Electrical and Plumbing (MEP) Applications

Pre-assembled MEP fasteners are available for use with the GCN-MEP concrete nailer designed for high-volume applications, such as affixing conduit clips, rod hangers, cable ties and ceiling clips.

With their 0.300" heads, these versatile pins and assemblies can also be used with common powder-actuated tools when fastening into harder substrates (structural steel or extra-hard concrete) when required.

Codes: ICC-ES ESR-2811; Florida FL-15730



Mechanical, Electrical and Plumbing Pins

All single-shot pins are 0.125" diameter x 1" except where specified.

Model No.	Description	Pack Quantity	Compatible Gas-Actuated Nailer
GRH25-R100	¼" Rod hanger with pin	100	GCN-MEP, T3
GRH37-R100	⅜" Rod hanger with pin	100	GCN-MEP, T3
GCC50-R100	½" Conduit clip with pin	100	GCN-MEP, T3
GCC75-R100	¾" Conduit clip with pin	100	GCN-MEP, T3
GCC100-R100	1" Conduit clip with pin	100	GCN-MEP, T3
GCC125-R50	1" Conduit clip (13 gauge steel) with pin	50	GCN-MEP, T3
GCL50-R50	½" Conduit clamp with pin	50	GCN-MEP, T3
GCL75-R25	¾" Conduit clamp with pin	25	GCN-MEP, T3
GAC-R100	Angle clip with pin	100	GCN-MEP, T3
GCT-R50	Tie-strap holder with pin	50	GCN-MEP, T3
GW50-R200	½" Dome washer with 0.110" or 0.128" x ½" step-shank pin	200	GCN-MEP, T3
GW75-R200	½" Dome washer with 0.125 x ¾" pin	200	GCN-MEP, T3
GW100-R100	½" Dome washer with pin	100	GCN-MEP, T3
GTS4-5075-R200	¼" Threaded stud, ½" length ¼-20 thread, ¾" length shank (0.127" dia.)	200	GCN-MEP, T3
GTH-R200	Tophat pin	200	GCN-MEP, T3

Extension Pole Tools

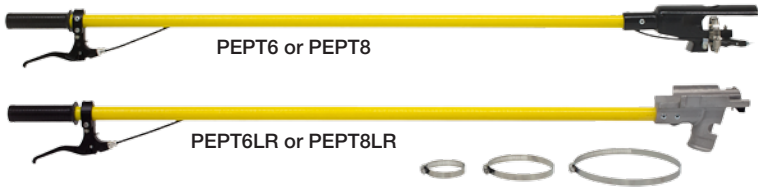

Advantages

- Modular lengths – 2 ft., 6 ft., 8 ft.
- Lightweight
- Eliminates need for scaffolding
- Rugged and durable design

Extension Poles for PT-27

Model	Description	Quantity
PEPT6	Complete 6 ft. pole	1
PEPT8	Complete 8 ft. pole	1

Extension poles for PTP-27L, PTP-27S, PTP-27SMAGR, PTP-27LMAGR, GCN-MEPMAG and GCN-MEP

Model	Description	Quantity
PEPT6LR	Complete 6 ft. pole	1
PEPT8LR	Complete 8 ft. pole	1

PAT Tool / Fastener Matrix

This matrix matches Simpson Strong-Tie powder-actuated tools with the powder loads and fasteners typically used with each tool.

Fasteners	Page No.	Premium Tools				Heavy-Duty Tool	General-Purpose Tools			
		PTP-27L (page 94)	PTP-27LMAGR (page 94)	PTP-27S (page 98)	PTP-27SMAGR (page 98)		PT-27HDA (page 102)	PT-27 (page 104)	PT-22A (page 106)	PT-22HA (page 108)
Loads										
P22AC (levels 2, 3, 4)	110							ALL	ALL	ALL
P22LRSC (levels 4, 5, 6, 7)	110									
P25SL (levels 3, 4, 5)	110									
P27LV (levels 4, 5, 6)	111					ALL				
P27SL (levels 2, 3, 4, 5)	111	ALL	ALL	ALL	ALL		ALL			
P27SL6	111	✓	✓	✓	✓					
0.300"-Headed Fasteners with 0.157" Shank Diameter										
PDPA-XXX	112	✓		✓		✓	✓	✓	Max 2½"	✓
PDPAW-XXX	112	✓		✓			✓	✓	✓	✓
PDPAWL-XXX	113	✓		✓			✓	✓	✓	✓
PDPAS-XXX	113	✓		✓						
PDPAT-XXX	114	✓		✓		✓	✓	✓	✓	✓
PCLDPA-XXX	114	✓		✓			✓	✓	✓	✓
PECLDPA-XXX	114	✓		✓			✓	✓	✓	✓
PTRHA3-XXX	114	✓		✓			✓	✓	✓	✓
0.300"-Headed Fasteners with 0.145" Shank Diameter										
PDPWL-XXSS	115	✓		Max 2"			✓	✓	✓	✓
PINW-XXX	115	✓		Max 2"			✓	✓	✓	✓
PINWP-XXX	115			Max 1½"			Max 2½"	✓	✓	Max 2½"
PHBC-XXX	116	Max 2½"		Max 1½"			Max 2½"	✓	✓	Max 2½"
PCC-XXX	116	✓		✓			✓	✓	✓	✓
PBXDP-100	116	✓		✓			✓	✓	✓	✓
8 mm-Headed Fasteners										
PHN-XXX	117	Max 2½"		Max 1⅝"		✓	Max 2½"	✓	✓	Max 2½"
PHNW-XXX	118			Max 2"			✓	✓	✓	✓
PHNT-XXX	118						✓	✓	✓	✓
PKP-250	119						✓	✓		✓
⅝"-Headed Fasteners / Threaded Studs										
PSLV3-XXX	117					✓				
¼"-Headed Fasteners / Threaded Studs										
PSLV4-XXX	116	✓		Max 1½"		✓	✓	✓	✓	✓

PAT Tool Matrix Powder-Actuated Fastening Systems





This matrix matches Simpson Strong-Tie® powder-actuated tools with the trades that would typically use each tool. The selection is based upon the features of the tool matching the needs of the trade.

Direct Fastening

Premium Tools				
	PTP-27L	PTP-27LMAGR	PTP-27S	PTP-27SMAGR
				
Features	<ul style="list-style-type: none"> • Automatic • Adjustable Power • Low Recoil/Noise • 2 1/2" Pin Capacity (4" Pin with Washer) 	<ul style="list-style-type: none"> • Fully Automatic • 10-Fastener Magazine • Adjustable Power • Low Recoil/Noise • 2 7/8" Pin Capacity 	<ul style="list-style-type: none"> • Automatic • Adjustable Power • Low Recoil/Noise • Drywall Track Tool • 1 5/8" Pin Capacity 	<ul style="list-style-type: none"> • Fully Automatic • Rotating Fastener Magazine • 10-Fastener Magazine • Adjustable Power • Low Recoil/Noise • 1 1/4" Pin Capacity
Cold-Formed Steel	Best	Better	Best	Better
Drywall	Good	Good	Best	Best
Electrical	Better		Better	
General	Best	Best		
Framer	Best	Best		
Plumbing/ Fire Sprinkler				
Acoustical/ Overhead	Good		Best	
Remodeling	Better	Better		
Carpentry	Better	Better		
Flooring	Better	Better	Good	Good
Glazing			Better	
HVAC	Better		Best	
Rental	Better			

PAT Tool Matrix Powder-Actuated Fastening Systems

This matrix matches Simpson Strong-Tie® powder-actuated tools with the trades that would typically use each tool. The selection is based upon the features of the tool matching the needs of the trade.

	Heavy-Duty Tool	General-Purpose Tools			
	PT-27HDA	PT-27	PT-22A	PT-22HA	PT-22P
					
Features	<ul style="list-style-type: none"> • Heavy-Duty • Single .27 Caliber Shot – Long • Reliable Design • 3/8" Threaded Stud Sprinkler Tool with Stop Spall 	<ul style="list-style-type: none"> • Semi-Automatic • Versatile • Reliable Professional Grade Tool • 2 1/2" Pin Capacity (4" Pin with Washer) 	<ul style="list-style-type: none"> • Single-Shot • Economical Professional-Grade Tool • 3" Pin Capacity (4" Pin with Washer) 	<ul style="list-style-type: none"> • Single-Shot • Hammer-Activated • Medium-Duty • 3" Pin Capacity 	<ul style="list-style-type: none"> • Single-Shot • Versatile, Professional-Grade Tool • 1 1/2" Pin Capacity • 2" Pin with Washer
Drywall		Good			Best
Electrical		Good	Good	Good	Better
General		Better	Good		
Framer		Good	Good		
Plumbing/ Fire Sprinkler	Best				Good
Acoustical/ Overhead		Better	Good		Better
Remodeling		Better	Best	Best	Good
Carpentry		Best	Better	Better	
Flooring	Best				
Glazing		Good	Good		Better
Hvac		Better			
Rental					

Direct Fastening

PTP-27L and PTP-27LMAGR Premium Tools

The PTP-27L and the PTP-27LMAGR are powder-actuated fastening tools designed to provide versatility and ease of use on the jobsite. Both tools deliver productive fastening with automatic piston reset, which enables the user to simply load and shoot. The PTP-27L is a single-shot tool with a longer barrel that can be easily affixed with a fastener magazine. The PTP-27LMAGR is a fully automatic tool with a fastener magazine that can rotate for easier access, or it can be quickly changed to a single-shot tool.



Features

- Adjustable power for fastening versatility: 1–1½ power-level range from a single strip
- Easy disassembly for cleaning and maintenance
- No manual resetting of piston required
- Operator comfort: cushioned grip, reduced recoil and sound-dampening muffler for quiet operation

Key Fastening Applications

- Sill plate installation
- Washered-pin installation (PTP-27L only)
- Insulation fastening (PTP-27L only)
- Forming work
- Cold-formed steel

Specifications

- Fastener Length:
 - PTP-27L:** ½" – 2½" (3" or 4" washered)
 - PTP-27LMAGR:** ⅝" – 2⅞"
- Fastener Type: 0.300" (or 8 mm) diameter headed
- Firing Action:
 - PTP-27L:** Automatic
 - PTP-27LMAGR:** Fully automatic
- **Load Caliber:** 0.27 strip loads, brown through purple (levels 2–6)
- **Length:** 17¾" (PTP-27L), 19½" (PTP-27LMAGR)
- **Weight:** PTP-27L – 6.5 lb., PTP-27LMAGR – 8.8 lb.

PTP-27L and PTP-27LMAGR Premium Tools**Available Kit Combinations**

PTP-27L: Single-shot configuration with accessories

PTP-LMAGR: Parts to convert PTP-27L into magazine configuration

PTP-27LMAGR: Magazine configuration with accessories

PTP-LCONKT: Parts to convert PTP-27LMAGR into a single-shot configuration

PTP-27LMAGRKT: Combination kit; includes tool and components for both single-shot and magazine configurations

Tool is sold in a rugged tool box complete with

- Operator's manual
- Spall suppressor
- Tools for disassembly
- Safety glasses/ear plugs
- Tool lubricant
- Cleaning brushes
- Operator's exam and caution sign
- Tool box also sold separately
- Gloves



The full line of Simpson Strong-Tie® powder loads and fasteners begins on page 110.

PTP-27L and PTP-27LMAGR Premium Tools

Direct Fastening



Quick-disconnect baseplate makes it easy to convert the PTP-27LMAGR from a magazine to a single-shot tool.

PTP-27L and PTP-27LMAGR Premium Tools

Complementary Products

Extension pole tool for the PTP-27L and PTP-27LMAGR available in 6' and 8' lengths



PEPT6LR – 6' Tool and PEPT8LR – 8' Tool

Extension Pole Tool for the PTP-27L — see page 90 for details.

Replacement Parts – PTP-27L

Description	Model No.
Baseplate	PTP-274800
Nosepiece	PTP-273820
Piston	PTP-273320
Piston Disc	PTP-273306
Rubber Returner	PTP-274305

Replacement Parts – PTP-27LMAGR

Description	Model No.
Magazine (Complete)	PTP-LMAGR
Nosepiece	PTP-276820
Nosepiece Screw	PTP-275826
Piston	PTP-276320
Piston Disc	PTP-273306
Rubber Returner	PTP-274305

Complete tool schematics, tool repair, maintenance kits and parts list are available at www.strongtie.com.

PTP-27S and PTP-27SMAGR Premium Tools

The PTP-27S and the PTP-27SMAGR are powder-actuated fastening tools designed to provide versatility and ease of use on jobs that require shorter fasteners. Both tools deliver productive fastening with automatic piston reset, which enables the user to simply load and shoot. The PTP-27S is a single-shot tool with a shorter barrel that can be easily affixed with a fastener magazine. The PTP-27SMAGR is a fully automatic tool with rotational fastener magazine that can be quickly changed to a single-shot tool.



Features

- Adjustable power for fastening versatility: 1–1½ power-level range from a single strip
- Operator comfort from cushioned grip, reduced recoil and sound-dampening muffler for quiet operation
- No manual resetting of piston required
- Easy disassembly for cleaning and maintenance

Key Fastening Applications

PTP-27S:

- Conduit clips
- Ceiling clips
- Drywall track
- Metal Decking

PTP-27SMAGR:

- Drywall track
- Hat channel
- HVAC duct straps
- Cold-formed steel
- Furring strips

Specifications

- Fastener Length:
PTP-27S: ½"–1 ⅝"
PTP-27SMAGR: ½"–1 ¼"
- Fastener Type: 0.300" or 8 mm diameter
- Firing Action:
PTP-27S: Automatic
PTP-27SMAGR: Fully automatic
- **Load Caliber:** 0.27 strip loads, brown through purple (levels 2–6)
- **Length:** 16¾" (PTP-27S), 17½" (PTP-27SMAGR)
- **Weight:** PTP-27S – 6.25 lb., PTP-27SMAGR – 8.1 lb.

PTP-27S and PTP-27SMAGR Premium Tools**Available Kit Combinations:**

PTP-27S: Single-shot configuration with accessories

PTP-SMAGR: Parts to convert PTP-27S into magazine configuration

PTP-27SMAGR: Magazine configuration with accessories

PTP-SCONKT: Parts to convert PTP-27SMAGR into a single-shot configuration

PTP-27SMAGRKT: Combination kit; includes tool and components for both single-shot and magazine configurations

Tool is sold in a rugged tool box complete with

- Operator's manual
- Spall suppressor
- Tools for disassembly
- Safety glasses / ear plugs
- Tool lubricant
- Cleaning brushes
- Operator's exam and caution sign
- Tool box also sold separately
- Gloves



The full line of Simpson Strong-Tie® powder loads and fasteners begins on page 110.

PTP-27S and PTP-27SMAGR Premium Tools

Direct Fastening



Rotating magazine allows for installation flexibility.



Quick-disconnect baseplate makes it easy to convert the PTP-27SMAGR from a magazine to a single-shot tool.



Collated pins make for fully automatic fastening and quick loading.

PTP-27S and PTP-27SMAGR Premium Tools

Complementary Products

Extension pole tool for the PTP-27S and PTP-27SMAGR available in 6' and 8' lengths

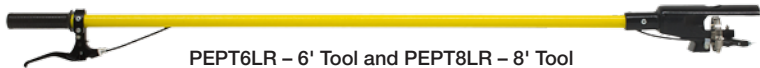

PEPT6LR – 6' Tool and PEPT8LR – 8' Tool

Extension Pole Tool for the PTP-27S — see page 90 for details.

Replacement Parts – PTP-27S

Description	Model No.
Baseplate	PTP-273800
Nosepiece	PTP-273820
Piston	PTP-273320
Piston Disc	PTP-273306
Rubber Returner	PTP-273305

Replacement Parts – PTP-27SMAGR

Description	Model No.
Magazine Body (Complete)	PTP-SMAGR
Nosepiece	PTP-275800
Nosepiece Screw	PTP-275826
Piston	PTP-273320
Piston Disc	PTP-273306
Rubber Returner	PTP-273305

Complete tool schematics, tool repair, maintenance kits and parts list are available at www.strongtie.com.

PT-27HDA Powder-Actuated Heavy-Duty Stud Driver

The PT-27HDA is a low-velocity, heavy-duty powder-actuated tool designed for installing fasteners into poured and precast concrete, grout-filled concrete masonry block and horizontal grouted joints, as well as structural steel. This tool offers easy-cycling, single-shot firing action for continuous use, high reliability and low maintenance. The PT-27HDA features a spall suppressor, which reduces concrete spalling and helps keep the tool perpendicular to the work surface.

**NEW**

PT-27HDA

Direct Fastening

Key Features

- Heavy-duty stud driver for installing fasteners into steel or hard concrete
- Easy cycling – pulling on the barrel ejects the shell and resets the piston
- Low recoil for greater operator comfort
- Spall suppressor to reduce concrete spalling and keep tool perpendicular to work surface
- Consistent and reliable performance
- Easy disassembly for cleaning and maintenance

Specifications

- Fastener length: 5/8" through 3"
- Fastener types: 1/4" – 20-threaded studs, 3/8" – 16-threaded studs, 8 mm-headed fasteners and 0.300"-headed fasteners with 0.157" shank diameter
- Firing action: Single shot
- Load caliber: 0.27 long single loads, yellow through purple (levels 3–6)
- Length: 14 1/2"
- Weight: 8 lb., 13 oz.

Key Fastening Applications

- 3/8" sprinkler fastenings
- Heavy-duty fastening in concrete strengths up to 8,000 psi
- Structural steel

PT-27HDA is sold in a durable box complete with

- Operator's manual
- Spall suppressor
- 8 mm fastener guide and pistons for use with PDPA, PSLV4 and PHN pins
- 10 mm fastener guide and pistons for use with PSLV3 pins
- Safety glasses / ear plugs
- Tool lubricant
- Cleaning brushes
- Operator's exam and caution sign
- 2 extra stop rings



Kit contents for PT-27HDA



Easy cycling: simply pull to eject the shell

Replacement Parts – PT-27HDA

Description	Model No.
8 mm Piston	PTHDA-700320
8 mm Guide Assembly	PTHDA-700340
10 mm Piston	PTHDA-700310
10 mm Guide Assembly	PTHDA-700330
Stop Ring / Buffer	PTHDA-700302

PT-27 General-Purpose Tool

The PT-27 is a semi-automatic and fast-cycling fastening tool that is engineered for continuous use, high reliability and low maintenance. This versatile tool fires a variety of fastener types and lengths.



PT-27

Key Fastening Applications

- Acoustical ceilings
- Electrical applications
- Sill plates
- Drywall track
- Water proofing material and/or lathing

Specifications

- Fastener Length: ½" – 2½" (3" or 4" washered)
- Fastener Type: .300" or 8 mm-headed fasteners or ¼"-20 threaded studs
- Firing Action: Semi-automatic
- Load Caliber: 0.27 strip loads, brown through red (levels 2-5)
- Length: 13½"
- Weight: 5 lb., 4 oz.

Tool is sold in a rugged tool box complete with

- Operator's manual
- Spall suppressor
- Tools for disassembly
- Safety glasses / ear plugs
- Tool lubricant
- Cleaning brushes
- Operator's exam and caution sign



The full line of Simpson Strong-Tie® powder loads and fasteners begins on page 110.

PT-27 General-Purpose Tool

Replacement Parts – PT-27

Description	Model No.
Annular Spring	PT-301014
Ball Bearing (6 mm)	PT-301013
Barrel	PT-301006
Baseplate	PT-301009
Piston – Concave (includes ring)	PT-301217
Piston – Flat (includes ring)	PT-301903
Piston Ring	PT-301208
Piston Stop	PT-301012
Shear Clip	PT-301011

For tool repair and maintenance kits and complete tool schematics and parts list, visit www.strongtie.com.

Complementary Products

Extension pole tool for the PT-27 available in 6' and 8' lengths



PEPT6 Tool and PEPT8 Tool

Extension Pole Tool for the PT-27 – see page 90 for details.

PT-22A General-Purpose Tool

The PT-22A is a powder-actuated tool that uses 0.22 caliber "A" crimp loads, has single-shot firing action and is engineered for continuous use, high reliability and low maintenance.



PT-22A

Key Fastening Applications

- Furring strips
- Framing pins
- Electrical boxes
- Ceiling clips

Specifications

- Fastener Length: ½" – 3" (3" and 4" washered)
- Fastener Type: 0.300" or 8-mm headed fasteners or ¼"-20 threaded studs
- Firing Action: Single shot
- Load Caliber: 0.22 single "A" crimp loads, brown through yellow (levels 2–4). Note: Not for use with 0.22-caliber straight wall loads.
- Length: 13⅞"
- Weight: 4.4 lb.

Tool is sold in a rugged tool box complete with

- Operator's manual
- Spall guard
- Tools for disassembly*
- Safety glasses / ear plugs*
- Cleaning brushes*
- Operator's exam and caution sign*

*These items not supplied with the PT-22A-RB retail package.

PT-22A Retail Package Product Data

Description	Model No.	Quantity of Tools Per Retail Package	Quantity of Retail Packages Per Carton
.22 Caliber, Single-Shot Trigger-Activated Tool	PT-22A-RB	1	2

PT-22A General-Purpose Tool

Replacement Parts

Description	Model No.
Nosepiece	PT22A-01
Piston Buffer	PT22A-02
Piston Reset Cap	PT22A-13
Piston Reset Pin	PT22A-11
Piston Reset Spring	PT22A-12
Piston with Ring	PT22A-03

1. Model PT-DC108 for tools with a serial number below 5000.
2. Model PT-DC107 for tools with a serial number below 5000.
3. Model PT-DC122 for tools with a serial number below 5000.
4. Complete tool schematics and parts list available at www.strongtie.com.



The PT-22A is sold individually in a tool box with accessories or in a retail package (see below).

The full line of Simpson Strong-Tie® powder loads and fasteners begins on page 110.



PT-22A-RB

PT-22HA General-Purpose Tool

The PT-22HA is a hammer-activated tool engineered for low maintenance and economy. The tool offers three levels of power: Brown through yellow loads (levels 2–4).



PT-22HA

Key Fastening Applications

- Remodeling
- Maintenance
- Electricians
- Telecommunications

Specifications

- Fastener Length: ½"–3" (4" washed)
- Fastener Type: 0.300" or 8 mm-headed fasteners or ¼"-20 threaded studs
- Firing Action: Single shot, hammer activated
- Load Caliber: 0.22 single "A" crimp loads, brown through yellow (levels 2–4). Note: Not for use with 0.22-caliber straight wall loads.
- Length: 14¼"
- Weight: 2 lb., 12 oz.



PT-22H Retail Package Product Data

Description	Model No.	Quantity of Tools Per Retail Package	Quantity of Retail Packages Per Carton
0.22 Caliber, Single-Shot Hammer-Activated Tool	PT-22HA-RB	1	4



The PT-22HA-RB comes packaged in a retail clamshell ready for merchandising.

PT-22P General-Purpose Tool

The PT-22P is a single-shot fastening tool engineered for continuous use, high reliability and low maintenance. The all-aluminum body of the PT-22P also provides rugged durability.



PT-22P

Key Fastening Applications

- Drywall track
- Furring strips
- Framing pins
- Electrical boxes
- Ceiling clips

Specifications

- Fastener Length: 1/2"–1 1/2"
- Fastener Type: 0.300" or 8 mm-headed fasteners or 1/4"-20 threaded studs
- Firing Action: Single shot
- Load Caliber: 0.22 single "A" crimp loads, brown through yellow (levels 2-4).
Note: Not for use with 0.22-caliber straight wall loads.
- Length: 14"
- Weight: 4 lb. 7 oz.

Tool is sold in a rugged tool box complete with

- Operator's manual
- Spall guard
- Tools for disassembly
- Safety glasses / ear plugs
- Cleaning brushes
- Operator's exam and caution sign
- One additional piston



The PT-22P is sold individually in a tool box with accessories.

Replacement Parts

Description	Model No.
Nosepiece	PT-22P-01
Stop Pin Cover	PT-22P-17
Barrel Stop Pin	PT-22P-20
Barrel Stop Pin Spring	PT-22P-21
Piston with Ring	PT-22P-02

Powder Loads for Powder-Actuated Tools

0.22-Caliber "A" Crimp Loads – Single Shot

Description	Model	Pack Quantity	Carton Quantity	Compatible Tools	
				Simpson	Others
.22 Cal. – Brown (Level 2)	P22AC2	100	10,000	PT-22A PT-22GS PT-22HA PT-22P	721, U-2000, DX-37E, DX72E, 4170 and model 70, System 3 and most low-velocity, single-shot tools
	P22AC2A	100	10,000		
.22 Cal. – Green (Level 3)	P22AC3	100	10,000		
	P22AC3A	100	10,000		
.22 Cal. – Yellow (Level 4)	P22AC4	100	10,000		
	P22AC4A	100	10,000		



P22AC

0.22-Caliber Straight Wall Loads – Single Shot

Description	Model	Pack Quantity	Carton Quantity	Compatible Tools
.22 Cal. – Yellow (Level 4)	P22LRSC4	100	10,000	Ladd Tools, and some special application tools
.22 Cal. – Red (Level 5)	P22LRSC5	100	10,000	
.22 Cal. – Purple (Level 6)	P22LRSC6	100	10,000	
.22 Cal. – Gray (Level 7)	P7LRSC	100	10,000	



P22LRSC

Note: Not for use with Simpson Strong-Tie PT-22, PT-22GS, or PT-22H tools.

0.25-Caliber Plastic 10-Shot Strip Loads

Description	Model	Pack Quantity	Carton Quantity	Compatible Tools
.25 Cal. – Green (Level 3)	P25SL3	100	10,000	DX35, R355
.25 Cal. – Green BULK PACK	P25SL3M	1,000	5,000	
.25 Cal. – Yellow (Level 4)	P25SL4	100	10,000	
.25 Cal. – Yellow BULK PACK	P25SL4M	1,000	5,000	
.25 Cal. – Red (Level 5)	P25SL5	100	10,000	
.25 Cal. – Red BULK PACK	P25SL5M	1,000	5,000	



P25SL

Powder Loads for Powder-Actuated Tools

0.27-Caliber Single-Shot Loads – Long

Description	Model	Pack Quantity	Carton Quantity	Compatible Tools
.27 Cal. – Yellow (Level 4)	P27LVL4	100	10,000	PT-27HDA, DX460, and Hilti DX600
.27 Cal. – Red (Level 5)	P27LVL5	100	10,000	
.27 Cal. – Purple (Level 6)	P27LVL6	100	10,000	



P27LVL

0.27-Caliber Plastic, 10-Shot Strip Loads

Description	Model	Pack Quantity	Carton Quantity	Compatible Tools	
				Simpson Strong-Tie	Others
.27 Cal. – Brown (Level 2)	P27SL2	100	10,000	PTP-27L, PTP-27MAGR, PTP-27S, PTP-27SMAGR, PT-27	DX-350, DX-351, DX-36, DX-A40 (except PT27SL2), DX-A41 (except PT27SL2 and PT27SL3), DX-460, DX-450, DX-451, DX-460, System 1H, P-36B, A-40B, A-41B, Cobra and most 0.27-caliber clone tools
	P27SL2A	100	10,000		
.27 Cal. – Green (Level 3)	P27SL3	100	10,000		
	P27SL3A	100	10,000		
.27 Cal. – Green BULK PACK	P27SL3M	1,000	5,000		
.27 Cal. – Yellow (Level 4)	P27SL4	100	10,000		
	P27SL4A	100	10,000		
.27 Cal. – Yellow BULK PACK	P27SL4M	1,000	5,000		
.27 Cal. – Red (Level 5)	P27SL5	100	10,000		
	P27SL5A	100	10,000		
.27 Cal. – Red BULK PACK	P27SL5M	1,000	5,000		
.27 Cal. – Purple (Level 6)	P27SL6	100	10,000		DX-450, DX-451, DX-A41

Note: An "A" in a part number denotes imported load. No "A" indicates a domestic load.



P27SL

Fasteners for Powder-Actuated Tools

PDPA Drive Pins

- Manufactured with tight tolerances for superior performance
- Code listed per ICC-ES ESR-2138; City of L.A. RR25469; Florida FL-15730

0.300"-Headed Fasteners with 0.157" Shank Diameter

Length (in.)	Model No.	Description	Pack Qty.	Carton Qty.	Compatible Tools	
					Simpson Strong-Tie	Others
½	PDPA-50	0.157 x ½"	100	1,000	PTP-27L PTP-27S PT-27 PT-27HDA PT-22A PT-22GS PT-22P PT-22HA	721, D-60, U-2000 and most other low- velocity tools
½ knurled	PDPA-50K	0.157 x ½" knurl	100	1,000		
⅝ knurled	PDPA-62K	0.157 x ⅝" knurl	100	1,000		
¾	PDPA-75	0.157 x ¾"	100	1,000		
1	PDPA-100	0.157 x 1"	100	1,000		
1 ⅙	PDPA-106	0.157 x 1 ⅙"	100	1,000		
1 ¼	PDPA-125	0.157 x 1 ¼"	100	1,000		
1 ⅝	PDPA-131	0.157 x 1 ⅝"	100	1,000		
1 ½	PDPA-150	0.157 x 1 ½"	100	1,000		
1 ⅞	PDPA-187	0.157 x 1 ⅞"	100	1,000		
2	PDPA-200	0.157 x 2"	100	1,000		
2 ½	PDPA-250	0.157 x 2 ½"	100	1,000		
2 ⅞	PDPA-287	0.157 x 2 ⅞"	100	1,000		



PDPA

This model available in mechanically galvanized finish (PDPA-287MG).

0.300"-Headed Fasteners with 0.157" Shank Diameter and ¾" Metal Washers

Length (in.)	Model No.	Description	Pack Qty.	Carton Qty.	Compatible Tools	
					Simpson Strong-Tie	Others
½	PDPAW-50	0.157 x ½", with ¾" washer	100	1,000	PTP-27L PTP-27S PT-27 PT-22P PT-22A PT-22GS PT-22HA	721, D-60, U-2000, System 1, System 3 and most other low- velocity tools
½ knurled	PDPAW-50K	0.157 x ½" knurl, with ¾" washer	100	1,000		
⅝ knurled	PDPAW-62K	0.157 x ⅝" knurl, with ¾" washer	100	1,000		
¾	PDPAW-75	0.157 x ¾", with ¾" washer	100	1,000		
1	PDPAW-100	0.157 x 1", with ¾" washer	100	1,000		
1 ¼	PDPAW-125	0.157 x 1 ¼", with ¾" washer	100	1,000		
1 ½	PDPAW-150	0.157 x 1 ½", with ¾" washer	100	1,000		
1 ⅞	PDPAW-187	0.157 x 1 ⅞", with ¾" washer	100	1,000		
2	PDPAW-200	0.157 x 2", with ¾" washer	100	1,000		
2 ½	PDPAW-250	0.157 x 2 ½", with ¾" washer	100	1,000		
2 ⅞	PDPAW-287	0.157 x 2 ⅞", with ¾" washer	100	1,000		



PDPAW

Fasteners for Powder-Actuated Tools

0.300"-Headed Fasteners with
0.157" Shank Diameter and 1" Metal Washers

Length (in.)	Model No.	Description	Pack Qty.	Carton Qty.	Compatible Tools	
					Simpson Strong-Tie	Others
½	PDPAWL-50	0.157 x ½", with 1" washer	100	1,000	PTP-27L PTP-27S PT-27 PT-22P PT-22A PT-22GS PT-22HA	721, D-60, U-2000, System 1, System 3 and most other low- velocity tools
½ knurled	PDPAWL-50K	0.157 x ½" knurl, with 1" washer	100	1,000		
⅝ knurled	PDPAWL-62K	0.157 x ⅝" knurl, with 1" washer	100	1,000		
¾	PDPAWL-75	0.157 x ¾", with 1" washer	100	1,000		
1	PDPAWL-100	0.157 x 1", with 1" washer	100	1,000		
1¼	PDPAWL-125	0.157 x 1¼", with 1" washer	100	1,000		
1½	PDPAWL-150	0.157 x 1½", with 1" washer	100	1,000		
1⅞	PDPAWL-187	0.157 x 1⅞", with 1" washer	100	1,000		
2	PDPAWL-200	0.157 x 2", with 1" washer	100	1,000		
2½	PDPAWL-250	0.157 x 2½", with 1" washer	100	1,000		
2⅞	PDPAWL-287	0.157 x 2⅞", with 1" washer	100	1,000		



PDPAWL

Direct Fastening

➤ This model available in mechanically galvanized finish (PDPAWL-287MG).

0.300"-Headed Fasteners with
0.157" Shank Diameter—10-Pin Collation

Length (in.)	Model No.	Description	Pack Qty.	Carton Qty.	Compatible Tools	
					Simpson Strong-Tie	Others
½	PDPAS-50	0.157 x ½"	100	1,000	PTP-27SMAGR PT-27LMAGR	DX-460 MAG and most other low-velocity magazine tools
½ knurled	PDPAS-50K	0.157 x ½" knurl	100	1,000		
⅝ knurled	PDPAS-62K	0.157 x ⅝" knurl	100	1,000		
¾	PDPAS-75	0.157 x ¾"	100	1,000		
1	PDPAS-100	0.157 x 1"	100	1,000		
1¼	PDPAS-125	0.157 x 1¼"	100	1,000		
1½	PDPAS-150	0.157 x 1½"	100	1,000		
1⅞	PDPAS-187	0.157 x 1⅞"	100	1,000		
2	PDPAS-200	0.157 x 2"	100	1,000		
2½	PDPAS-250	0.157 x 2½"	100	1,000		
2⅞	PDPAS-287	0.157 x 2⅞"	100	1,000		



PDPAS

Fasteners for Powder-Actuated Tools

0.300"-Headed Tophat Fasteners
with 0.157" Shank Diameter

Length (in.)	Model No.	Description	Pack Qty.	Carton Qty.	Compatible Tools	
					Simpson Strong-Tie	Others
½ knurled	PDPAT-50K	0.157 x ½" knurl	100	1,000	PTP-27L PTP-27S PT-27 PT-27HDA PT-22A PT-22GS PT-22P PT-22HA	721, D-60, U-2000 and most other low-velocity tools
⅝ knurled	PDPAT-62K	0.157 x ⅝" knurl	100	1,000		
¾	PDPAT-75	0.157 x ¾"	100	1,000		
1	PDPAT-100	0.157 x 1"	100	1,000		



PDPAT

Pre-Assembled Ceiling Clips –
0.300"-Headed Fasteners with 0.157" Shank Diameter

Length (in.)	Model No.	Description	Pack Qty.	Carton Qty.	Compatible Tools	
					Simpson Strong-Tie	Others
⅞	PCLDPA-87	Ceiling Clip with ⅞" Pin	100	1,000	PTP-27L PTP-27S PT-27 PT22A PT-22GS PT-22P PT-22HA	DX-350 System 1 721 DX-351, DX-460, Ramset Viper, Ramset Viper 4 and most other tools
1 ⅛	PCLDPA-106	Ceiling Clip with 1 ⅛" Pin	100	1,000		
1 ⅝	PCLDPA-131	Ceiling Clip with 1 ⅝" Pin	100	1,000		
1 ⅞	PECLDPA-106	Compact Ceiling Clip with 1 ⅞" Pin	100	1,000		
1 ⅞	PECLDPA-131	Compact Ceiling Clip with 1 ⅞" Pin	100	1,000		



PCLDPA



PECLDPA

Threaded Rod Hangers –
0.300"-Headed Fasteners with 0.157" Shank Diameter

Length (in.)	Model No.	Description	Pack Qty.	Carton Qty.	Compatible Tools	
					Simpson Strong-Tie	Others
1 ⅝, ¼ – 20 Threaded Rod Hanger	PTRHA4-131	0.157 x 1 ⅝"	50	500	PTP-27L PTP-27S PT-27 PT-22P PT-22A PT-22GS PT-22HA	DX-350 DX-36 DX-35 DX-A40 DX-460
1 ⅝, ⅜ – 16 Threaded Rod Hanger	PTRHA3-131	0.157 x 1 ⅝"	50	500		



PTRHA3

Fasteners for Powder-Actuated Tools

Type-304 Stainless-Steel 0.300"-Headed Fasteners with 0.145" Shank Diameter and 1" Metal Washers*

Length (in.)	Model No.	Pack Qty.	Carton Qty.	Compatible Tools	
				Simpson Strong-Tie	Others
1	PDPWL-1004SS	100	1,000	PTP-27L PTP-27S** PT-27 PT-22P PT-22A PT-22GS PT-22HA	721**, D-60, DX-460, U-2000, System 1, System 3 and most other low-velocity tools
1¼	PDPWL-1254SS	100	1,000		
1½	PDPWL-1504SS	100	1,000		
2	PDPWL-2004SS	100	1,000		

*Washers are Type-304 Stainless-Steel

**Up to 2"



PDPWL-SS

0.300"-Headed Fasteners with 0.145" Shank Diameter and 1 7/16" Metal Washers

Length (in.)	Model No.	Pack Qty.	Carton Qty.	Compatible Tools	
				Simpson Strong-Tie	Others
1	PINW-100	50	500	PTP-27L PT-27 PT-22P PT-22A PT-22GS PT-22HA	721, D-60, U-2000, System 1, System 3 and most other low-velocity tools
1¼	PINW-125	50	500		
1½	PINW-150	50	500		
2¼	PINW-225	50	500		
2½	PINW-250	50	500		
3	PINW-300	50	500		



PINW

0.300"-Headed Fasteners with 0.145" Shank Diameter and 1 3/8" Plastic White Washers

Length (in.)	Model No.	Pack Qty.	Carton Qty.	Compatible Tools	
				Simpson Strong-Tie	Others
1	PINWP-100W	50	500	PTP-27L PT-27 PT-22P PT-22A PT-22GS PT-22HA	721*, D-60, DX-460, U-2000, System 1, System 3 and most other low-velocity tools
1¼	PINWP-125W	50	500		
1½	PINWP-150W	50	500		
1¾	PINWP-175W	50	500		
2	PINWP-200W	50	500		
2½	PINWP-250W	50	500		
3	PINWP-300W	50	500		



PINWP

*Up to 2½"

Fasteners for Powder-Actuated Tools

Highway Basket Clips – 0.300"-Headed Fasteners with 0.145" Shank Diameter

Description	Model No.	Pack Qty.	Carton Qty.	Compatible Tools	
				Simpson Strong-Tie	Others
Clip with 1½" Pin	PHBC-150	100	1,000	PTP-27L, PT-27 PT-22P, PT-22A PT-22GS PT-22HA	DX-A41, Autofast
Clip with 2" Pin	PHBC-200	100	1,000		
Clip with 2½" Pin	PHBC-250	50	1,000		



PHBC

Pre-Assembled BX Cable Straps and Conduit Straps – 0.300"-Headed Fasteners with 0.145" Shank Diameter

Description	Model No.	Pack Qty.	Carton Qty.	Compatible Tools	
				Simpson Strong-Tie	Others
BX Cable Strap with 1" Pin	PBXDP-100	100	1,000	PTP-27L PTP-27S PT-27 PT-22P PT-22A PT-22GS PT-22HA	D-60, 721, System 1, System 3, DX-350 and most other tools
Conduit Clip ½" EMT with 1" Pin	PCC50-DP100	100	1,000		
Conduit Clip ¾" EMT with 1" Pin	PCC75-DP100	50	500		
Conduit Clip 1" EMT with 1" Pin	PCC100-DP100	50	500		



PCC



PBXDP

¼" – 20 Threaded Studs*

Length (in.)	Model No.	Pack Qty.	Carton Qty.	Compatible Tools	
				Simpson Strong-Tie	Others
¼ - 20 Knurled (T-½, S-½)	PSLV4-5050K	100	1,000	PTP-27 PTP-27L PT-27 PT-22A PT-22GS PT-22HA	Most low-velocity tools
¼ - 20 (T-½, S-¾)	PSLV4-5075	100	1,000		
¼ - 20 (T-½, S-1)	PSLV4-50100	100	1,000		
¼ - 20 (T-½, S-1¼)	PSLV4-50125	100	1,000		
¼ - 20 (T-¾, S-¾)	PSLV4-7575	100	1,000		
¼ - 20 Knurled (T-¾, S-½)	PSLV4-7550K	100	1,000		
¼ - 20 (T-¾, S-1)	PSLV4-75100	100	1,000		
¼ - 20 (T-¾, S-1¼)	PSLV4-75125	100	1,000		
¼ - 20 (T-1, S-1)	PSLV4-100100	100	1,000		
¼ - 20 Knurled (T-1¼, S-½)	PSLV4-12550K	100	1,000		
¼ - 20 (T-1¼, S-1¼)	PSLV4-125125	100	1,000		



PSLV4

*Shank diameter is 0.150". NOTE: T = thread length, S = shank length.

Fasteners for Powder-Actuated Tools

 $\frac{3}{8}$ " – 16 Threaded Stud* (Factory Mutual Listing-see below)

Length (in.)	Model No.	Pack Qty.	Carton Qty.	Compatible Tools	
				Simpson Strong-Tie	Others
$\frac{3}{8}$ - 16 Knurled (T-1 $\frac{1}{4}$, S- $\frac{3}{4}$)	PSLV3-12575K	100	1,000	PT-27HDA	DX-600 and most other $\frac{3}{8}$ " barrel tools
$\frac{3}{8}$ - 16 (T-1 $\frac{1}{4}$, S-1)	PSLV3-125100	100	1,000		
$\frac{3}{8}$ - 16 (T-1 $\frac{1}{4}$, S-1 $\frac{1}{4}$)	PSLV3-125125**	100	1,000		

*Shank diameter is 0.205". NOTE: T = thread length, S = shank length.

**Factory Mutual Listing 3031724



PSLV3



Metric Fasteners

8mm-Headed Fasteners with 3.68mm Shank Diameter

Length (in.)	Model No.	Pack Qty.	Carton Qty.	Compatible Tools	
				Simpson Strong-Tie	Others
$\frac{1}{2}$ Knurled	PHN-14K	100	1,000	PTP-27L PTP-27S** PT-27 PT-22P** PT-22A PT-22GS PT-22HA*	DX-350 DX-36 DX-400E DX-A40 DX-460 DX-A41 System 1 DX-351 and 8mm tools
$\frac{5}{8}$ Knurled	PHN-16K	100	1,000		
$\frac{3}{4}$ Knurled	PHN-19K	100	1,000		
$\frac{7}{8}$	PHN-22	100	1,000		
1	PHN-27	100	1,000		
1 $\frac{1}{4}$	PHN-32	100	1,000		
1 $\frac{1}{2}$	PHN-37	100	1,000		
1 $\frac{5}{8}$	PHN-42	100	1,000		
1 $\frac{7}{8}$	PHN-47	100	1,000		
2	PHN-52	100	1,000		
2 $\frac{1}{4}$	PHN-57	100	1,000		
2 $\frac{1}{2}$	PHN-62	100	1,000		
2 $\frac{7}{8}$	PHN-72	100	1,000		

*Up to 2 $\frac{1}{2}$ "

**Up to 1 $\frac{1}{2}$ "



PHN

Fasteners for Powder-Actuated Tools

Metric Fasteners

8mm-Headed Fasteners with
3.68mm Shank Diameter and 1" Metal Washers

Length (in.)	Model No.	Pack Qty.	Carton Qty.	Compatible Tools	
				Simpson Strong-Tie	Others
1	PHNW-27	100	1,000	PTP-27L PTP-27S* PT-27 PT-22P PT-22A PT-22GS PT-22HA	DX-350 DX-36 DX-400E DX-A40 DX-A41 DX-460 System1 DX-351 and 8mm tools
1¼	PHNW-32	100	1,000		
1½	PHNW-37	100	1,000		
1⅝	PHNW-42	100	1,000		
1⅞	PHNW-47	100	1,000		
2	PHNW-52	100	1,000		
2¼	PHNW-57	100	1,000		
2½	PHNW-62	100	1,000		
2⅞	PHNW-72	100	1,000		



PHNW

*Up to 2"

8mm-Headed Tophat Fasteners
with 3.68mm Shank Diameter

Length (in.)	Model No.	Pack Qty.	Carton Qty.	Compatible Tools	
				Simpson Strong-Tie	Others
⅝ Knurled	PHNT-16K	100	1,000	PTP-27 PTP-27L PTP-27S PT-27 PT-22P PT-22A PT-22GS PT-22HA	DX-35 DX-350 DX-460 and most 8mm tools
¾ Knurled	PHNT-19K	100	1,000		
⅞	PHNT-22	100	1,000		
1	PHNT-27	100	1,000		



PHNT

Fasteners for Powder-Actuated Tools

Concrete Forming Pin – 0.187"-Headed
with 0.145" Shank Diameter

Length (in.)	Model No.	Pack Qty.	Carton Qty.	Compatible Tools	
				Simpson Strong-Tie	Others
3/16 x 2 1/2 Concrete Forming Pin	PKP-250	100	1,000	PTP-27L, PT-27 PT-22P, PT-22A PT-22GS, PT-22HA	DX-Series and 8mm tools

Note: Lengths in inches are for reference only and may not be exact.



PKP

Miscellaneous

1/4"-Headed Hammer Drive Fastener with 3/8" Metal Washer

Length (in.)	Model No.	Pack Qty.	Carton Qty.	Compatible Tools	
				Simpson Strong-Tie	Others
3/4	PHD-75	100	1,000	PHT-38	HT-38, R-260, R-375, XL-143 and other hammer drive tools
1	PHD-100	100	1,000		
1 1/4	PHD-125	100	1,000		



PHD

Manual Hammer Tool
(not for use with powder loads)



PHT-38



Warning: Do not use powder loads with this tool. This is a hammer drive tool only. Use of powder loads with this tool may result in injury or death.

Fasteners for Powder-Actuated Tools

Powder-Actuated Tool Repair and Maintenance Kits

Tool	Kit Model No.	Description	Contents
PT-27	PT-27PK1	Normal wear part replacement kit	5 Shear Clips (Part No. PT-301011)
			1 Annular Spring (Part No. PT-301014)
			1 Piston Stop (Part No. PT-301012)
			3 Ball Bearings (Part No. PT-301013)
			1 Piston (Part No. PT-301903)
			2 Piston Rings (Part No. PT-301208)
			1 Nosepiece (Part No. PT-301010)
All	PT-MK1	Tool cleaning kit	1 Cleaning Brush – Wire (Part No. BRUSH 125)
			1 Cleaning Brush ¾" Diameter (Part No. BRUSH 25)
			1 Cleaning Brush ¼" Diameter (Part No. BRUSH 75)
			1 PAT Tool Lubricant – 4 oz. Spray Bottle (Part No. PT-MTL4.0)
			(1) ⅝" Hex Wrench (Part No. MW-18)
			(1) ¾" Hex Wrench (Part No. MW-316)
			(1) 5mm Hex Wrench (Part No. MW-5)
All	PT-MTL2.0	Tool lubricant	2 oz. Spray Bottle

Gas- and Powder-Actuated Fastening Safety Principles

Before operating any Simpson Strong-Tie® gas- or powder-actuated tool, you must read and understand the Operator's Manual and be trained by an authorized instructor in the operation of the tool. Simpson Strong-Tie highly recommends you read and fully understand the safety guidelines of the tool you use. You must then pass a test and receive a certified operator card to become a Certified Operator. The test and Operator's Manual are included with each tool kit, or certification can be obtained by taking the test online at www.strongtie.com.

GENERAL SAFETY

To avoid serious injury or death:

- ALWAYS make sure that the operator and bystanders wear safety glasses. Hearing and head protection are also recommended.
- ALWAYS post warning signs when gas- or powder-actuated tools are in use. Signs should state "Tool in Use" and should be posted within the area where the tool is being used.
- ALWAYS store gas- or powder-actuated tools unloaded. Tools, loads and gas cells should be stored in a locked container out of the reach of children.
- NEVER place any part of your body over the front muzzle of the tool even if no fastener is present. The fastener, pin or tool piston can cause serious injury or death in the event of an accidental discharge.
- NEVER transport fasteners or other hard objects in the same pocket or container with powder loads or fuel cells. These objects may strike the powder loads or puncture the fuel cell, thereby setting them off and causing serious injury or death.
- NEVER attempt to bypass or circumvent any of the safety features on a gas- or powder-actuated tool.
- ALWAYS keep the tool pointed in a safe direction.
- ALWAYS keep your finger off the trigger until ready to shoot.
- ALWAYS keep the tool unloaded until ready to use.

INSTALLATION SAFETY

To avoid serious injury or death:

- ALWAYS hold the tool perpendicular (90°) to the fastening surface to prevent ricocheting fasteners. Use the spall guard whenever possible.
- NEVER attempt to fasten to soft, thin, brittle or very hard materials such as drywall, light gauge steel, glass, tile or cast iron as these materials are inappropriate. Conduct a pre-punch test to determine base material adequacy.
- NEVER attempt to fasten to soft material like wood or drywall (fastening through soft materials into an appropriate base material may be allowed if the application is appropriate).
- NEVER attempt to fasten to a spalled, cracked or uneven surface.



Safety equipment, such as safety glasses and ear plugs, is recommended when using gas- or powder-actuated tools.

Restoration Solutions



SIMPSON

Strong-Tie

Simpson Strong-Tie offers a line of products designed for structural and architectural rehabilitation of concrete and masonry.

Our restoration solutions provide reliable, easy-to-use products for a variety of applications, including structural restoration, pick-proof sealing and water-intrusion prevention.

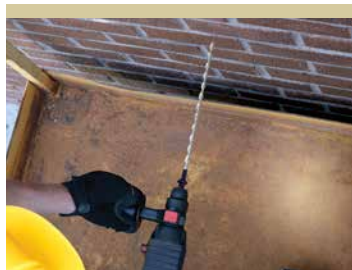

ETI Injection Epoxy

ETI injection epoxies are two-component, high-solids formulations for injection into cracks in concrete. Dispensed through a static mixing nozzle using either a manual, battery-powered or a pneumatic dispensing tool, these epoxies provide a waterproof, high-strength (structural) repair.



ETI-SLV

ETI-LV

ETI-GV

Features

- Bonds chemically to concrete, providing structural repair (meets the requirements of ASTM C 881 for structural repair epoxy)
- Formulated for maximum penetration under pressure (all viscosities)
- Seals out moisture, protecting rebar in the concrete from corrosion and flooring from moisture damage
- Reliable mixing and ratio control when used with the Simpson Strong-Tie® Optimix® static mixing nozzle (included with cartridge)
- Suitable for pressure injection or gravity-feed applications
- Non-shrink material resists oils, salts and mild chemicals
- Final product color: ETI-SLV – dark purple / black; ETI-LV – amber; ETI-GV – gray

ETI-SLV Super-Low-Viscosity Epoxy

- Super-low viscosity (350 cP) repairs hairline cracks (0.002") and cracks up to 1/4" in width
- Penetrates smallest cracks
- Meets or exceeds AASHTO M-235 and ASTM C881 Type I and IV, Grade 1, Class B and C

ETI-LV Low-Viscosity Epoxy

- Repairs fine to medium cracks 1/64" to 1/4" in width
- Offers low surface tension to effectively penetrate narrow cracks
- Approved under NSF/ANSI standard 61
- Meets or exceeds AASHTO M-235 and ASTM C881 Type I and IV, Grade 1, Class C

ETI-GV Gel-Viscosity Epoxy

- Gel-viscosity (non-sag) epoxy repairs medium cracks 3/32" – 1/4" in width
- Decreases in viscosity under pressure, increasing flow
- Suitable for use as pick-proof sealant around doors, windows and fixtures
- Meets or exceeds AASHTO M-235 and ASTM C881 Type I and IV, Grade 3, Class C

ETI Injection Epoxy

Application Considerations

- Suitable for repairing non-moving cracks in concrete walls, floors, slabs, columns and beams.
- ETI can be used to inject cracks in damp or wet conditions (non-seeping or non-leaking conditions only) with excellent results.
- Apply to concrete 60°F or above. For best results, warm material to 60°F or above prior to application.
- Mixed material in nozzle and injection fitting hardens in 15 minutes (ETI-SLV), and in 60 minutes (ET-LV, ETI-GV) at temperatures of 40°F or above.

Shelf Life: 24 months from date of manufacture in unopened cartridge

Storage Conditions: For best results, store between 45°F and 95°F

Injection Instructions: See pages 216–219.

ETI Cartridge System¹

Model No.	Capacity in Ounces (cubic in.)	Dispensing Tool	Mixing Nozzle
ETISLV	16.5 (29.8)	EDT22S	EMN022 (included)
ETILV22	22 (39.7)		
ETIGV22			

1. Bulk containers also available. Contact Simpson Strong-Tie for details.
2. Use only appropriate Simpson Strong-Tie® mixing nozzles in accordance with Simpson Strong-Tie instructions. Modification or improper use of mixing nozzle may impair epoxy performance.
3. EDT22s tool must be configured for 2:1 cartridge ratio.

Crack-Pac® Injection Epoxy

The Crack-Pac® injection epoxy is designed to repair cracks in concrete ranging from 1/64" to 1/4" wide in concrete walls, floors, slabs, columns and beams. The mixed adhesive has the viscosity of a light oil and a low surface tension, allowing it to penetrate fine to medium-width cracks in dry, damp or wet conditions with excellent results. Resin is contained in the cartridge and hardener is contained in the nozzle.

Features

- Dispenses with a standard caulking tool, no special dispensing tool needed
- Clean and easy to mix
- Seals out moisture, protecting rebar in the concrete from corrosion and flooring from moisture damage
- Chemically bonds with the concrete to restore strength
- Non-shrink material resistant to oils, salts and mild chemicals
- Meets the requirements of AASHTO M-235 and ASTM C881, Type IV, Grade 1, Class C

Application Considerations

- Suitable for repair of cracks ranging from 1/64" to 1/4" wide in concrete walls, floors, slabs, columns and beams
- Can be used to inject cracks in dry, damp or wet conditions with excellent results. Not for use in actively leaking cracks.
- In order for components to mix properly, the resin and hardener must be conditioned to 60°F–80°F before mixing

Shelf Life: 24 months from date of manufacture, unopened

Storage Conditions: For best results, store between 45°F and 95°F

Injection Instructions: See pages 214–215.

Crack-Pac® Cartridge System

Model No.	Capacity in Ounces (cubic in.)	Cartridge Type	Carton Quantity	Dispensing Tool
ETIPAC10	9 (16.2)	single	12	CDT10S or standard caulking tool
ETIPAC10KT	18 (32.4)	single	2 (kits)	



Crack-Pac® Injection Epoxy (ETIPAC10)

Dispensing Systems:
U.S. Patents 6,737,000
and 6,896,001 B2

Crack-Pac® Injection Epoxy**Complementary Products**

Crack-Pac® injection epoxy is also available in the Crack-Pac Injection Kit. (ETIPAC10KT). The kit includes everything needed to pressure inject approximately 8 lineal feet of cracks (assumes a concrete thickness of 4" and 1/16" crack width).

- 2 Crack-Pac cartridge/nozzle sets
- 12 E-Z-Click injection ports
- 2 E-Z-Click injection fittings with 12" tubing
- 1 pint of ETR paste-over epoxy (8 oz. of resin + 8 oz. of hardener)
- 4 disposable wood paste-over applicators
- 1 pair latex gloves
- Installation video



**Crack-Pac® Kit
(ETIPAC10KT)**



**Crack-Pac® Kit
Components**

Complementary Products

**Crack-Pac®
Injection Epoxy**
9 oz. Cartridge



CDT10S
Manual dispensing tool for acrylic
adhesive dispensing cartridges
(page 24)

Crack-Pac® Flex-H₂O™ Polyurethane Crack Sealer

The Crack-Pac® Flex-H₂O™ polyurethane injection resin seals leaking cracks, voids or fractures from 1/32" to 1/4" wide in concrete or solid masonry. Designed to perform in applications where water is seeping or mildly leaking from the crack, the polyurethane is packaged in the cartridge and an accelerator is packaged in the nozzle. When the resin encounters water as it is injected into the crack, it becomes an expanding foam that provides a flexible seal in leaking and non-leaking cracks.

Features

- Can be dispensed with a standard caulking tool
- Can also be used on dry cracks if water is introduced to affected area
- Can be used with a reduced amount or without accelerator to slow down reaction time
- Expands to fill voids and seal the affected area
- Fast reacting – reaction begins within 1 minute after exposure to moisture; expansion may be completed within 3 minutes (depending on the amount of moisture and the ambient temperature)
- 20:1 expansion ratio (unrestricted rise) means less material needed

Application Considerations

- Suitable for sealing cracks ranging from 1/32" to 1/4" wide in concrete and solid masonry.
- Suitable for repair of cracks in dry, damp and wet conditions with excellent results. Designed to perform in applications where water is seeping or mildly leaking from the crack.
- In order for components to mix properly, the resin and hardener must be conditioned to 60°F–90°F before mixing.

Shelf Life: 12 months from the date of manufacture, unopened

Usage Temperature: 60°F to 90°F

Storage Conditions: For best results, store in a dry area between 45°F and 90°F. Product is very moisture sensitive.

Installation Instructions: See pages 214-215.

Crack-Pac® Flex-H₂O™ Cartridge System

Model No.	Capacity Ounces	Carton Quantity
CPFH09	9	12
CPFH09KT	18	2 (kits)

**Crack-Pac® Flex-H₂O™ Crack Sealer**

Dispensing System:
U.S. Patents
6,737,000 and
6,896,001 B2

Crack-Pac® Flex-H₂O™ Bulk Packaging

Model No.	Description	Capacity
FH05*	Flex-H ₂ O Resin	5 Gallons
	Flex-H ₂ O Catalyst	16 Ounces

*For standard reaction time, use a 30:1 resin: catalyst ratio. For a faster reaction time, add more catalyst; for a slower reaction time, use less.

Accessories: See page 130 for information on mixing nozzles and for crack repair accessories.

Additional Components Needed for Crack Repair

Condition	Paste-Over Material	Ports
Dry Crack	ETR or CIP-F*	EIP-EZA Flush-Mount
Wet Crack		
Seeping Crack	Hydraulic Cement	EIPX-EZ Drill-In
Mildly Leaking Crack		

*CIP-F requires EIP-EZA port.

Complementary Products

Crack-Pac® Flex-H₂O™ Kit (CPFH09KT)

- 2 Crack-Pac Flex-H₂O cartridge/nozzle sets
- 12 E-Z-Click injection ports
- 2 E-Z-Click injection fittings with 12" tubing

Crack-Pac® Flex-H₂O™ Kit Components

- 1 pint of ETR paste-over epoxy (8 oz. of resin + 8 oz. of hardener)
- 4 disposable wood paste-over applicators
- 1 pair latex gloves

Crack Repair Accessories



EMN22
Optimix®
Mixing Nozzle



E-Z-Click
Ports and Injection Fitting



EIP-EZA
Flush-Mount
Port



ETR16



EIPX-EZ
Corner Mount/
Drilled-In Port

Crack Injection Paste-Over in Cartridge Delivery System

Model No.	Capacity in Ounces	Carton Quantity
CIP-F	22	10



CIP-F



E-Z-Click
Injection Fitting

Crack Repair Accessories

Crack Repair Accessories Product Data

Description	Model No.	Package Quantity	Carton Quantity (ea.)
6 Optimix® mixing nozzles for ETI epoxies (6 ½" long, ¾" square). Includes retaining nuts. ¹	EMN022-RP6	6	30 (5 Packs)
100 E-Z-Click flush-mount injection ports and 1 E-Z-Click injection fitting	EIP-EZA	—	100
20 E-Z-Click flush-mount injection ports and 1 E-Z-Click injection fitting (compatible with all Simpson Strong-Tie paste-overs)	EIP-EZAKT	—	5 Kits
20 E-Z-Click corner mount/ drilled-in injection ports ²	EIPX-EZ-RP20	20	100 (5 Packs)
20 E-Z-Click corner mount/ drilled-in injection ports and 1 E-Z-Click injection fitting ²	EIPX-EZKT	—	5 Kits
E-Z-Click injection fitting	EIF-EZ	1	10
ETR Kit containing 1 8-oz. canister of resin and 1 8-oz. canister of hardener	ETR16	—	4 Kits

1. Use only an appropriate Simpson Strong-Tie® mixing nozzle in accordance with Simpson Strong-Tie instructions. Modification or improper use of mixing nozzle may impair epoxy performance.
2. EIPX intended for use as a surface mount port in corners and a drilled-in port on flat surfaces. All accessories compatible with ETI-SLV, ETI-LV and ETI-GV epoxies.

Detailed information on the full line of Simpson Strong-Tie® manual and pneumatic dispensing tools is available on pages 24-26.

Heli-Tie™ Helical Wall Tie

The Heli-Tie™ is a stainless-steel helical tie used to anchor building façades to structural members or to stabilize multiple-wythe brick walls.

The helical design allows the tie to be driven quickly and easily into a predrilled pilot hole (or embedded into mortar joints in new construction) to provide a mechanical connection between a masonry façade and its backup material or between multiple wythes of brick. As it is driven, the fins of the tie undercut the masonry to provide an expansion-free anchorage that will withstand tension and compression loads.

The Heli-Tie wall tie is installed using a proprietary setting tool that is used with an SDS-PLUS shank rotohammer to drive and countersink the tie. Heli-Tie wall ties perform in concrete and masonry as well as wood and steel studs.



Heli-Tie™ Helical Wall Tie

U.S. Patent 7,269,987

Features

- Installs quickly and easily — with the rotohammer in hammer mode, the tie installs faster than competitive products.
- Provides an inconspicuous repair that preserves the appearance of the building. After installation, the tie is countersunk up to ½" below the surface, allowing the tie location to be patched.
- Larger core diameter provides higher torsional capacity, resulting in less deflection due to "uncoiling" under load.
- Fractionally sized anchor — no metric drill bits required.
- Patented manufacturing process results in a more uniform helix along the entire tie, allowing easier driving and better interlock with the substrate.

Material: Type 304 stainless steel (Type 316 available by special order — contact Simpson Strong-Tie for details)

Test Criteria: CSA A370

Installation

- Drill pilot hole through the façade material and into the backup material to the specified embedment depth + 1" using appropriate drill bit(s). Drill should be in rotation-only mode when drilling into soft masonry or into hollow backing material.
- Position blue end of the Heli-Tie™ fastener in the installation tool and insert the tie into the pilot hole.
- With the SDS-PLUS rotohammer in hammer mode, drive the tie until the tip of the installation tool enters the exterior surface of the masonry and countersinks the tie below the surface. Patch the hole in the façade.



Heli-Tie™ Helical Wall Tie

Heli-Tie™ Product Data

Size (in.)	Model No.	Drill Bit Diameter (in.)	Quantity	
			Box	Carton
3/8 x 7	HELI37700A	7/32 or 1/4	50	400
3/8 x 8	HELI37800A		50	400
3/8 x 9	HELI37900A		50	400
3/8 x 10	HELI371000A		50	200
3/8 x 11	HELI371100A		50	200
3/8 x 12	HELI371200A		50	200
3/8 x 14	HELI371400A		50	200
3/8 x 16	HELI371600A		50	200
3/8 x 18	HELI371800A		50	200
3/8 x 20	HELI372000A		50	200

Installation Sequence

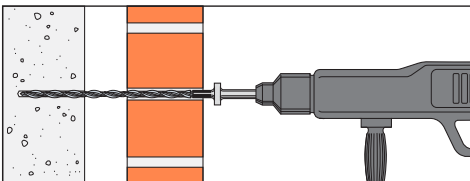
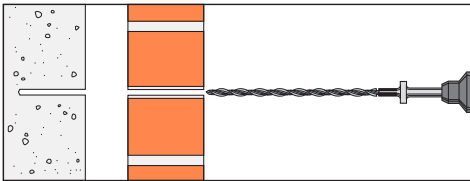
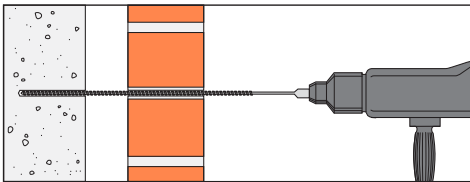

Special-order lengths are also available;
contact Simpson Strong-Tie for details.

Heli-Tie™ Helical Stitching Tie

The Simpson Strong-Tie® Heli-Tie™ helical stitching tie provides a unique solution to the preservation and repair of damaged brick and masonry structures. Ties are grouted into existing masonry to repair cracks and increase strength with minimum disturbance. Made of Type 304 stainless steel, the Heli-Tie stitching tie features radial fins formed on the steel wire via cold rolling process, increasing the tensile strength of the tie.

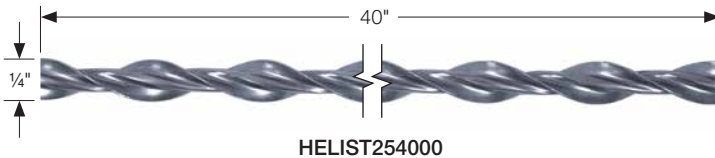

Features

- Helical design distributes loads uniformly over a large surface area
- Installs into the mortar joint to provide an inconspicuous repair and preserve the appearance of the structure
- Type 304 stainless steel offers superior corrosion resistance to original reinforcement
- Patented manufacturing process results in consistent, uniform helix configuration (U.S. Patent 7,269,987)
- Batch number printed on each tie for easy identification and inspection

HELIST254000: 1/4" x 40" stitching tie

Material: Type 304 stainless steel

Ordering Information: Sold in tubes of 10

Installation Instructions

- Chase bed joint 20" on either side of the affected area to a depth of approximately 1 1/4" with a rotary grinding wheel. Vertical spacing of installation sites should be 12" for red brick or "every other course" for concrete masonry units.
- Clear bed joint of all loose debris.
- Mix non-shrink repair grout or mortar per product instructions and place into the prepared bed joint, filling the void to approximately two-thirds of its depth. Simpson Strong-Tie FX-263 repair mortar may be used.
- Embed the tie at one-half the depth of the void. Trowel displaced grout to fully encapsulate the tie.
- Fill any remaining void and vertical cracks with non-shrink repair grout or other repair mortar to conceal repair site.

Installation Sequence

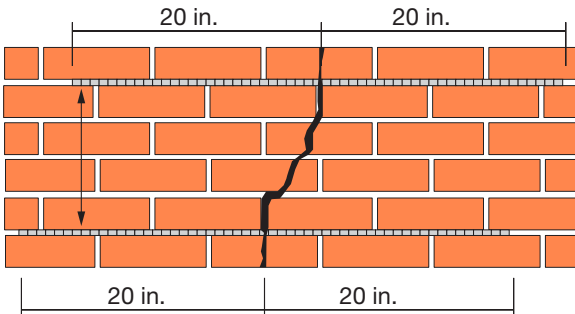
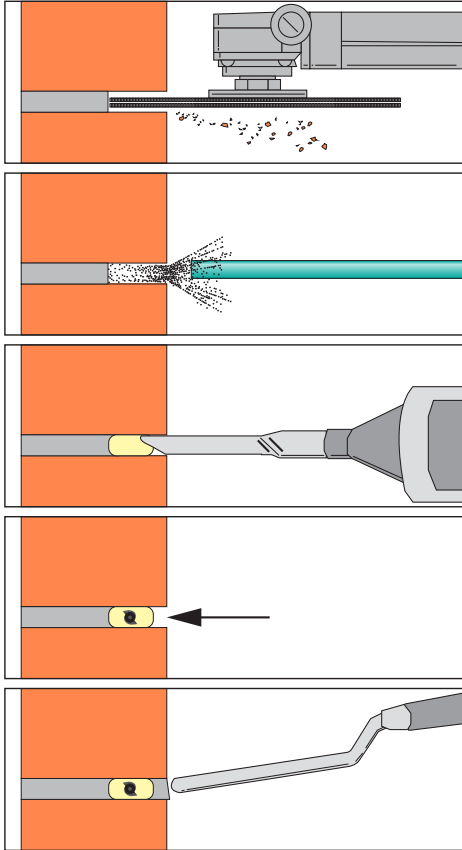

Heli-Tie™ Helical Wall Tie**Complementary Products****Heli-Tie™ Fastener Installation Tool —
Model HELITOOOL37A**

Required to correctly install the Heli-Tie wall ties, this tool speeds up installation and automatically countersinks the tie into the façade material. The one-piece design with no moving parts, improves longevity and prevents the Heli-Tie fasteners from jamming. Installation tools sold separately.

**HELITOOOL37A****Heli-Tie™ Wall Tie Tension Tester —
Model HELITEST37A**

Recommended equipment for on-site testing to accurately determine load values in any specific structure, the Heli-Tie wall tie tension tester features a key specifically designed to grip the Heli-Tie fastener and provide accurate results. Replacement test keys sold separately (Model HELIKEY37A).

**HELITEST37A****HELIKEY37A**



Innovative mobile and desktop apps put the technical resources of Simpson Strong-Tie at your fingertips! Visit **www.strongtie.com/software** to view and download our latest releases.

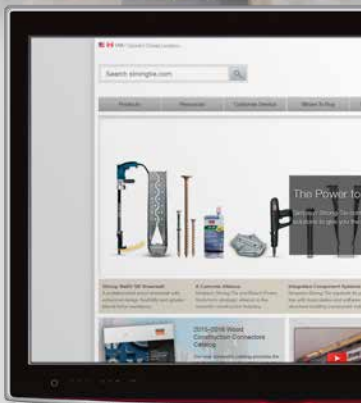

Restoration Solutions

Carbide Drill Bits



Simpson Strong-Tie offers a complete line of premium-quality drill bits, core bits and chisels to handle any drilling demolition and concrete preparation need. Our carbide products are manufactured to demanding tolerances and are designed to maximize production on the jobsite.

Our carbide-tipped drill bits are premium-quality, professional-grade tools manufactured in Germany to the highest industry standards. They are designed to meet precise ANSI tolerance requirements and incorporate proprietary features that enhance durability, drilling speed and usability. Regular and quad-head bit and solid-tip configurations are available. Shank styles include SDS-PLUS®, SDS-MAX®, spline and straight.



Carbide Drill Bits for Concrete and Masonry

Carbide Drill Bit Selection Information

Our carbide-tipped drill bits are premium-quality, professional-grade tools manufactured in Germany to the highest industry standards for Simpson Strong-Tie.

They are designed to meet precise ANSI tolerance requirements and incorporate proprietary features that enhance durability and drilling speed, while improving ease of use. Regular and quad-head bit tip and solid-tipped configurations are available. Shank styles include SDS-PLUS, SDS-MAX, spline and straight.

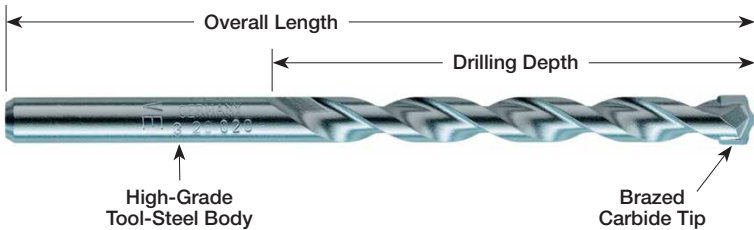

Features and Benefits

- Uniformly brazed carbide inserts result in longer bit life
- Most bits contain a centering tip that facilitates easy spot drilling
- Chromium-nickel-molybdenum steel alloy body ensures hammering quality and extended service life
- Heat-treatment procedures and shot-peened finish increase surface hardness and drilling speed, reduce drill bit wear and improve resistance to bending forces
- Drill bits conform to ANSI Standard B212.15

Additional Features for SDS-MAX, Spline and Select SDS-PLUS Bits:

- Chisel-shaped drill bit head penetrates the material and directs concrete dust into the multi-flute spiral
- Patented, high-volume, multi-flute spiral quickly channels concrete dust from the hole to improve drilling speed
- 4 x 90° head geometry crushes through rebar and prevents sticking in reinforced concrete



Solid-Tip Carbide Drill Bit

Carbide Drill Bits for Concrete and Masonry**Quad-Head Feature**

(Available in SDS-PLUS, SDS-MAX and spline shank)

All the features of single cutter bits and the quad-head dual-cutter are designed to improve durability and drilling speed. The high-volume, double-helix design of the quad-head bit comes with the patented, high-performance, reinforced core flute to maximize energy transfer.

Simpson Strong-Tie® drill bits come in various shank styles to fit virtually any drill or rotohammer.



Carbide Drill Bits for Concrete and Masonry

Drill Bit Tool Selection Guide

SDS-PLUS

Fits all current and older SDS-PLUS rotohammers from AEG, Black & Decker, Bosch, DeWalt, Hilti, Hitachi, Kango, Makita, Metabo, Milwaukee, Porter Cable, Ramset, Red Head, Ryobi, Skil

SDS-MAX

Fits all current and older SDS-MAX rotohammers from Black & Decker, Bosch, DeWalt, Hilti, Hitachi, Kango, Makita, Metabo, Milwaukee

Spline

Fits all current and older Spline rotohammers from AEG, Black & Decker, Bosch, DeWalt, Hitachi, Kango, Makita, Metabo, Milwaukee, Ramset, Red Head, Ryobi

The following are registered trademarks of the respective holders:

AEG® – AEG Power Tool Corp.
 Bosch® – Robert Bosch Power Tool Corp.
 SDS-PLUS® and SDS-MAX® are registered trademarks of Robert Bosch Power Tool Corp.
 B&D® – Black and Decker US, Inc.
 Hilti® – Hilti of America, Inc.
 Hitachi® – Hitachi Power Tools USA, Ltd.
 Kango® – Kango Wolf Power Tools, Inc.
 Makita® – Makita USA, Inc.
 Metabo® – Metabo Corp.
 Milwaukee® – Milwaukee Electric Tool Corp.
 Porter Cable® – Porter Cable Corporation
 Ramset® – Illinois Tool Works
 Red Head® – Illinois Tool Works
 Ryobi® – Ryobi America Corporation



SDS-PLUS Drill Bits

SDS-PLUS Shank Bits

Diameter (in.)	Drilling Depth (in.)	Overall Length (in.)	Model No.
5/32	2	4 1/4	MDPL01504
	4	6 1/4	MDPL01506
3/16	2	4 1/4	MDPL01804
	4	6 1/4	MDPL01806
	6	8 1/4	MDPL01808
	8	10	MDPL01810
	10	12	MDPL01812
	12	14	MDPL01814
7/32	4	6 1/4	MDPL02106
	6	8 1/4	MDPL02108
	11	8 3/4	MDPL02111
	14	16	MDPL02116
	18	20	MDPL02120
1/4	2	4 1/4	MDPL02504
	4	6 1/4	MDPL02506
	6	8 1/4	MDPL02508
	9	11	MDPL02511
	12	14	MDPL02514
	14	16	MDPL02516
5/16	4	6 1/4	MDPL03106
	10	12	MDPL03112
3/8	4	6 1/4	MDPL03706
	8	10 1/4	MDPL03710
	10	12 1/4	MDPL03712
	16	18	MDPL03718
	22	24	MDPL03724
7/16	4	6 1/4	MDPL04306
	10	12 1/4	MDPL04312
1/2	4	6 1/4	MDPL05006
	8	10 1/4	MDPL05010
	10	12 1/4	MDPL05012
	16	18	MDPL05018
	22	24	MDPL05024
9/16	4	6 1/4	MDPL05606
	10	12 1/4	MDPL05612
	16	18	MDPL05618
5/8	6	8	MDPL06208
	10	12	MDPL06212
	16	18	MDPL06218
	22	24	MDPL06224
1 1/16	6	8	MDPL06808
	8	10	MDPL07508
3/4	8	10	MDPL07510
	10	12	MDPL07512
	16	18	MDPL07518
	22	24	MDPL07524
	27	30	MDPL07530
1 3/16	6	8	MDPL08108
	8	10	MDPL08108
7/8	6	8	MDPL08708
	10	12 1/4	MDPL08712
	16	18	MDPL08718
1	8	10	MDPL10010
	16	18	MDPL10018

SDS-PLUS Shank Bit

SDS-PLUS bits use an asymmetrical-parabolic flute for efficient energy transmission and dust removal.



SDS-PLUS Drill Bits

SDS-PLUS Solid-Tip Carbide Drill Bits

Diameter (in.)	Total Length (in.)	Drilling Depth (in.)	Model No.
3/16	4 1/4	2	MDPL01804S
3/16	6 1/4	4	MDPL01806S
3/16	8 1/4	6	MDPL01808S
3/16	12	10	MDPL01812S
1/4	6 1/4	4	MDPL02506S
1/4	8 1/4	6	MDPL02508S
1/4	12	10	MDPL02512S
5/16	6 1/4	4	MDPL03106S
5/16	12	10	MDPL03112S
3/8	6 1/4	4	MDPL03706S
3/8	12 1/4	10	MDPL03712S
1/2	6 1/4	4	MDPL05006S
1/2	12 1/4	10	MDPL05012S
9/16	6	4	MDPL05606S
9/16	12	10	MDPL05612S



Solid-Tip Carbide Drill Bit

SDS-PLUS Quad Head Drill Bits

Diameter (in.)	Drilling Depth (in.)	Overall Length (in.)	Model No.
5/8	6	8	MDPL06208Q
	10	12	MDPL06212Q
	16	18	MDPL06218Q
3/4	6	8	MDPL07508Q
	10	12	MDPL07512Q
	16	18	MDPL07518Q
7/8	6	8	MDPL08708Q
	10	12	MDPL08712Q
	16	18	MDPL08718Q
1	8	10	MDPL10010Q
	16	18	MDPL10018Q
1 1/8	8	10	MDPL11210Q
	16	18	MDPL11218Q
1 1/4	16	18	MDPL12518Q



Quad Head

SDS-PLUS Drill Bits

SDS-PLUS Shank Bits — Retail Packs

Diameter (in.)	Drilling Depth (in.)	Overall Length (in.)	Quantity (per pack)	Model No.
5/32	4	6 1/4	25	MDPL01506-R25
3/16	2	4 1/4	25	MDPL01804-R25
	4	6 1/4	25	MDPL01806-R25
	6	8 1/4	25	MDPL01808-R25
	8	10	25	MDPL01810-R25
	10	12	25	MDPL01812-R25
	12	14	25	MDPL01814-R25
7/32	4	6 1/4	25	MDPL02106-R25
	6	8 1/4	25	MDPL02108-R25
	8 3/4	11	25	MDPL02111-R25
1/4	2	4 1/4	25	MDPL02504-R25
	4	6 1/4	25	MDPL02506-R25
	6	8 1/4	25	MDPL02508-R25
	8 3/4	11	25	MDPL02511-R25
5/16	4	6 1/4	25	MDPL03106-R25
3/8	4	6 1/4	25	MDPL03706-R25
	8	10 1/4	25	MDPL03710-R25
	10	12 1/4	25	MDPL03712-R25
1/2	4	6 1/4	25	MDPL05006-R25
	8	10 1/4	25	MDPL05010-R25
	10	12 1/4	25	MDPL05012-R25
5/8	6	8	20	MDPL06208-R20



SDS-PLUS Retail Packs



Fixed-Depth Drill Bit

Carbide Drill Bits

Fixed-Depth Drill Bits

Model No.	Drill Bit Diameter (in.)	Drill Depth (in.)	Drop-In Anchor (in.)
Standard Drop-In Anchors (DIAB, DIA)			
MDPL037DIA	3/8	1 1/16	1/4
MDPL050DIA	1/2	1 11/16	3/8
MDPL062DIA	5/8	2 1/16	1/2
Short Drop-In Anchors (DIAS)			
MDPL050DIAS	1/2	1 11/16	3/8
MDPL062DIAS	5/8	2 1/16	1/2

SDS-PLUS Drill Bits

Titen® Screw Drill Bit/Driver Product Data*

Diameter (in.)	Drilling Depth (in.)	Overall Length (in.)	For Screw Diameter (in.)	Model No.
5/32	2 3/8	5	3/16	MDPL01505H
	3 1/8	6	3/16	MDPL01506H
	4 1/8	7	3/16	MDPL01507H
3/16	2 3/8	5	1/4	MDPL01805H
	3 1/8	6	1/4	MDPL01806H
	4 1/8	7	1/4	MDPL01807H

Product is sold individually.

Titen® Screw Drill Bit/Driver — Bulk Packs*

Diameter (in.)	Drilling Depth (in.)	Overall Length (in.)	For Screw Diameter (in.)	Model No.
5/32	2 3/8	5	3/16	MDPL01505H-R25
	4 1/8	7	3/16	MDPL01507H-R25
3/16	2 3/8	5	1/4	MDPL01805H-R25
	4 1/8	7	1/4	MDPL01807H-R25

*SDS-PLUS Shank



Special hex adaptor (included with the Titen® Screw installation kit) allows the Titen installation tool to slide over the bit and lock in, ready to drive Titen concrete and masonry screws. Rotohammer must be in rotation-only mode before driving screws.

SDS-PLUS and SDS-MAX Drill Bits

SDS-MAX and SDS-MAX Quad Head Shank Bits

Diameter (in.)	Drilling Depth (in.)	Overall Length (in.)	Model No.
3/8	7 1/2	13	MDMX03713
1/2	7 1/2	13	MDMX05013
	15 1/2	21	MDMX05021
9/16	7 1/2	13	MDMX05613
	15 1/2	21	MDMX05621
5/8	7 1/2	13	MDMX06213Q
	15 1/2	21	MDMX06221Q
	30 1/2	36	MDMX06236Q
1 1/16	15 1/2	21	MDMX06821Q
3/4	8	13	MDMX07513Q
	17	21	MDMX07521Q
	31	36	MDMX07536Q
1 3/16	17	21	MDMX08121Q
7/8	8	13	MDMX08713Q
	17	21	MDMX08721Q
	31	36	MDMX08737Q
1	8	13	MDMX10013Q
	17	21	MDMX10021Q
	31	36	MDMX10036Q
1 1/16	18	23	MDMX10623Q
1 1/8	12	17	MDMX11217Q
	17	21	MDMX11221Q
	31	36	MDMX11236Q
1 3/16	18	23	MDMX11823Q
1 1/4	10	15	MDMX12515Q
	18	23	MDMX12523Q
	31	36	MDMX12536Q
1 3/8	12	17	MDMX13717Q
	18	23	MDMX13723Q
1 1/2	18	23	MDMX15023Q
1 3/4	18	23	MDMX17523Q
2	18	23	MDMX20023Q

Model numbers ending with "Q" denote Quad Head.



Quad Head
Model numbers ending with "Q" denote quad-head bits.



SDS-MAX
Shank Bit

Spline/Straight Shank Drill Bits

Spline Shank Bits

Diameter (in.)	Drilling Depth (in.)	Overall Length (in.)	Model No.
3/8	5	10	MDSP03710
	8	13	MDSP03713
	11	16	MDSP03716
7/16	8	13	MDSP04313
1/2	5	10	MDSP05010
	8	13	MDSP05013
	11	16	MDSP05016
	17	22	MDSP05022
	24	29	MDSP05029
	31	36	MDSP05036
9/16	8	13	MDSP05613
	11	16	MDSP05616
	18	23	MDSP05623
5/8	5	10	MDSP06210
	8	13	MDSP06213
	11	16	MDSP06216
	17	22	MDSP06222
	24	29	MDSP06229
	31	36	MDSP06236
11/16	8	13	MDSP06813
	11	16	MDSP06816
3/4	5	10	MDSP07510
	8	13	MDSP07513
	11	16	MDSP07516
	17	22	MDSP07522
	24	29	MDSP07529
	31	36	MDSP07536
7/8	11	16	MDSP08716
	17	22	MDSP08722
	31	36	MDSP08736
1	11	16	MDSP10016
	17	22	MDSP10022
	31	36	MDSP10036
1 1/8	11	16	MDSP11216
	17	22	MDSP11222
1 1/4	11	16	MDSP12516
	17	22	MDSP12522
1 3/8	11	16	MDSP13716
	17	22	MDSP13722
1 1/2	11	16	MDSP15016
	17	22	MDSP15022
1 3/4	17	22	MDSP17522
2	17	22	MDSP20022



Spline Shank Bit

Spline shank bits continued on the next page.

Spline/Straight Shank Drill Bits

Spline Shank Quad Head Bits

Diameter (in.)	Drilling Depth (in.)	Overall Length (in.)	Model No.
5/8	5	10	MDSP06210Q
	11	16	MDSP06216Q
	17	22	MDSP06222Q
	24	29	MDSP06229Q
	31	36	MDSP06236Q
11/16	11	16	MDSP06816Q
3/4	5	10	MDSP07510Q
	11	16	MDSP07516Q
	17	22	MDSP07522Q
	24	29	MDSP07529Q
	31	36	MDSP07536Q
7/8	11	16	MDSP08716Q
	17	22	MDSP08722Q
1	11	16	MDSP10016Q
	17	22	MDSP10022Q
	31	36	MDSP10036Q
1 1/8	11	16	MDSP11216Q
	17	22	MDSP11222Q
1 1/4	11	16	MDSP12516Q
	17	22	MDSP12522Q
	31	36	MDSP12536Q
1 3/8	11	16	MDSP13716Q
	17	22	MDSP13722Q
1 1/2	17	22	MDSP15022Q
1 3/4	18	23	MDSP17523Q
2	18	23	MDSP20023Q



Spline Shank Bit



Quad Head



'A' Taper Bit

'A' Taper Shank Bits

Diameter (in.)	Drilling Depth (in.)	Overall Length (in.)	Model No.
1/2	7	9	MDA05007
5/8	7	9	MDA06207
3/4	16	18	MDA07516

Spline/Straight Shank Drill Bits

Straight Shank Bits

Diameter (in.)	Drilling Depth (in.)	Overall Length (in.)	Model No.
1/8	1 3/8	3	MDB01203
3/16	1 9/16	3 1/2	MDB01803
	4	6	MDB01806
1/4	2 1/8	4	MDB02504
	4	6	MDB02506
	10	12	MDB02512
5/16	2 3/4	4 3/4	MDB03104
	4	6	MDB03106
3/8	4	6	MDB03706
	10	12	MDB03712
7/16	4	6	MDB04306
1/2	4	6	MDB05006
	10	12	MDB05012
	22	24	MDB05024
5/8	3 1/2	6	MDB06206
	10	12	MDB06212
	22	24	MDB06224
3/4	4	6	MDB07506
	10	12	MDB07512
7/8	4	6	MDB08706
	10	12	MDB08712
1	4	6	MDB10006
	10	12	MDB10012

Bits have recessed shank to fit Titen® screws and other masonry screw installation tools. They also work in three-jaw-style chucks.



Straight Shank Bit

Straight Shank Bits – Retail Packs

Diameter (in.)	Drilling Depth (in.)	Overall Length (in.)	Quantity (per pack)	Model No.
1/8	1 3/8	3	25	MDB01203-R25
3/16	1 9/16	3 1/2	25	MDB01803-R25
	4	6	25	MDB01806-R25
1/4	2 1/8	4	25	MDB02504-R25
	4	6	25	MDB02506-R25
5/16	2 3/4	4 3/4	25	MDB03104-R25
	4	6	25	MDB03106-R25
3/8	4	6	25	MDB03706-R25
1/2	4	6	25	MDB05006-R25
5/8	4	6	20	MDB06206-R20



Rebar Cutters/Adaptors

Rebar Cutters*

When hole placement conflicts with rebar or wire mesh, these bits enable the rebar to be removed so the hole can be drilled to the proper depth. Rebar cutters are separate from shanks. Shanks work with all sizes of rebar cutters. Overall length is approximately 15".

* After drilling through the reinforcement or plate, remove debris from the hole and resume drilling with carbide-tipped drill bit.



Rebar Cutter Detail



Rebar Cutter

Diameter (in.)	Drilling Depth (in.)	Model No.
1/2	12	MCR05012
5/8	12	MCR06212
3/4	12	MCR07512
7/8	12	MCR08712
1	12	MCR10012

Plate Cutters*

Similar to rebar cutters, these bits are designed for cutting through steel base plates when it is necessary to enlarge the fixture hole. These bits can also be used as rebar cutters. Plate cutters are separate from shanks. Shanks work with all sizes of plate cutters.

* After drilling through the reinforcement or plate, remove debris from the hole and resume drilling with carbide-tipped drill bit.



Plate Cutter Detail



Plate Cutter

Diameter (in.)	Drilling Depth (in.)	Model No.
1/2	12	MCP05012
5/8	12	MCP06212
3/4	12	MCP07512
7/8	12	MCP08712
1	12	MCP10012

Rebar Cutters/Adaptors

Shanks for Rebar and Plate Cutters

Shank Style	Model No.	Description
Straight	MC	For use in drills with jawed chucks. Use in rotation-mode only.
SDS-PLUS	MCSDP	For use in SDS-PLUS style drills. Use in rotation-mode only.
SDS-MAX	MCSDM	For use in SDS-MAX style drills. Shank design allows rotation only.
Spline	MCS	For use in spline-style drills. Shank design allows rotation only.



SDS-PLUS Shank



Spline Shank

Drill Bit Shank Adaptors

Description (shank style to bit type)	Model No.
SDS-MAX to SDS-PLUS Adaptor	ADMX2PL
Spline to SDS-PLUS Adaptor	ADSP2PL
SDS-top to SDS-PLUS Adaptor	ADST2PL



SDS-MAX to SDS-PLUS Adaptor



Spline to SDS-PLUS Adaptor

SDS-Top
(T-ET style) to SDS-PLUS Adaptor

Demolition Chisels and Bits

Simpson Strong-Tie® chisels are made of toughened steel with special surface treatment that improves performance. The superior tempering process creates a hardened surface that is more wear-resistant and allows the working point to be re-sharpened, which extends the life of the tool.

Simpson Strong-Tie® demolition chisels and bits come in various shank styles to fit virtually any demolition tool.



SDS-MAX



SDS-PLUS



Splined

(Design disables rotohammer rotation.)



3/4" Hex

Scrapers

Removing Tiles, Flooring and Other Materials

Shank Type	Head Width (in.)	Overall Length (in.)	Model No.
SDS-PLUS	3/4	10	CHPLF07510
	1 1/2	10	CHPLSC15010
SDS-MAX	2	12	CHMXSCP20012
Splined	2	12	CHSPSCP20012



Scraper

Flat Chisels

General Concrete and Masonry Demolition

Shank Type	Head Width (in.)	Overall Length (in.)	Model No.
SDS-MAX	1	12	CHMXF10012
	1	18	CHMXF10018
Splined	1	12	CHSPF10012
	1	18	CHSPF10018
3/4" Hex	1	12	CHHF10012
	1	18	CHHF10018



Flat Chisel

Demolition Chisels and Bits

Bull Point Chisels

General Concrete and Masonry Demolition

Shank Type	Overall Length (in.)	Model No.
SDS-PLUS	10	CHPLBP10
SDS-MAX	12	CHMXBP12
	18	CHMXBP18
Spline	12	CHSPBP12
	18	CHSPBP18
¾" Hex	12	CHHBP12
	18	CHHBP18



Bull Point Chisel

Asphalt Cutters

Asphalt, Hardpan and Compacted Soil Cutting

Shank Type	Head Width (in.)	Overall Length (in.)	Model No.
SDS-MAX	3½	16	CHMXAC35016
¾" Hex	3½	16	CHHAC35016



Asphalt Cutter

Clay Spades

Clay and Other Rock-Free Soil Cutting

Shank Type	Head Width (in.)	Overall Length (in.)	Model No.
Spline	5%	16	CHSPCS53716
Clay Spade	5%	16	CHHCS53716



Clay Spade

Demolition Bits

Scalers

Removing Large Quantities of Material

Shank Type	Head Width (in.)	Overall Length (in.)	Model No.
SDS-MAX	1½	12	CHMXSC15012
	2	12	CHMXSC20012
	3	12	CHMXSC30012
Spline	1½	12	CHSPSC15012
	2	12	CHSPSC20012
	3	12	CHSPSC30012
¾" Hex	2	12	CHHSC20012
	3	12	CHHSC30012



Scaler

Ground Rod Drivers

Driving in Ground Rods

Shank Type	Head Width (in.)	Overall Length (in.)	Model No.
SDS-MAX	7/8	10¼	CHMXRD08710
Spline	7/8	10¼	CHSPRD08710



Ground Rod Driver

Bushing Tools One Piece

Concrete and Asphalt Surface Roughening

Shank Type	Head Width (in.)	Overall Length (in.)	Model No.
SDS-MAX	1¾	9½	CHMXBT17509
Spline	1¾	9¼	CHSPBT17509
Bushing Tool	1¾	9¼	CHHBT17509



Bushing Tool Head

Core Bits

Core Bits

Simpson Strong-Tie® Core Bits are made to the same exacting standards as our standard carbide-tipped drill bits. They utilize a centering bit to facilitate accurate drilling in combination hammer/drill mode.

Core Bits with Centering Bit – SDS-MAX Shank

Diameter (in.)	Drilling Depth (in.)	Overall Length (in.)	Model No.
1½	6¼	11¾	CBMX15011
		22	CBMX15022
2	6¼	11¾	CBMX20011
		22	CBMX20022
2½	6¼	11¾	CBMX26211
		22	CBMX26222
3½	6¼	11¾	CBMX31211
		22	CBMX31222
3½	6¼	22	CBMX35022
4	6¼	11¾	CBMX40011
		22	CBMX40022
5	6¼	11¾	CBMX50011
		22	CBMX50022
6	6¼	22	CBMX60022

NOTE: With 1-piece bits, once coring is begun, the centering bit must be removed using ejector pin. Core bit bodies are 2¼" deep.



Core bit transfers energy efficiently

Core Bits

Core Bits with Centering Bit –
Spline Shank

Diameter (in.)	Drilling Depth (in.)	Overall Length (in.)	Model No.
1½	6¼	11¾	CBSP15012
		22	CBSP15022
2	6¼	11¾	CBSP20011
		22	CBSP20022
2½	6¼	11¾	CBSP26211
		22	CBSP26222
3¼	6¼	11¾	CBSP31211
		22	CBSP31222
3½	6¼	11¾	CBSP35011
		22	CBSP35022
4	6¼	11¾	CBSP40011
		22	CBSP40022
5	6¼	11¾	CBSP50011
		22	CBSP50022

Core Bit Replacement Parts

Core Bit Center Pilot Bit

Diameter (in.)	Overall Length (in.)	Model No.
7/16	4¾	CTRBTF04304

Ejector Key

Diameter (in.)	Model No.
¾	CDBEJKEY

Appendix

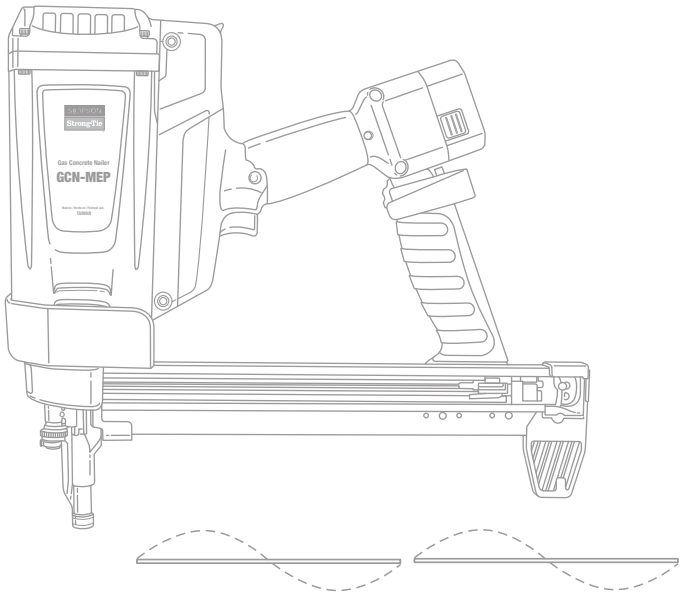
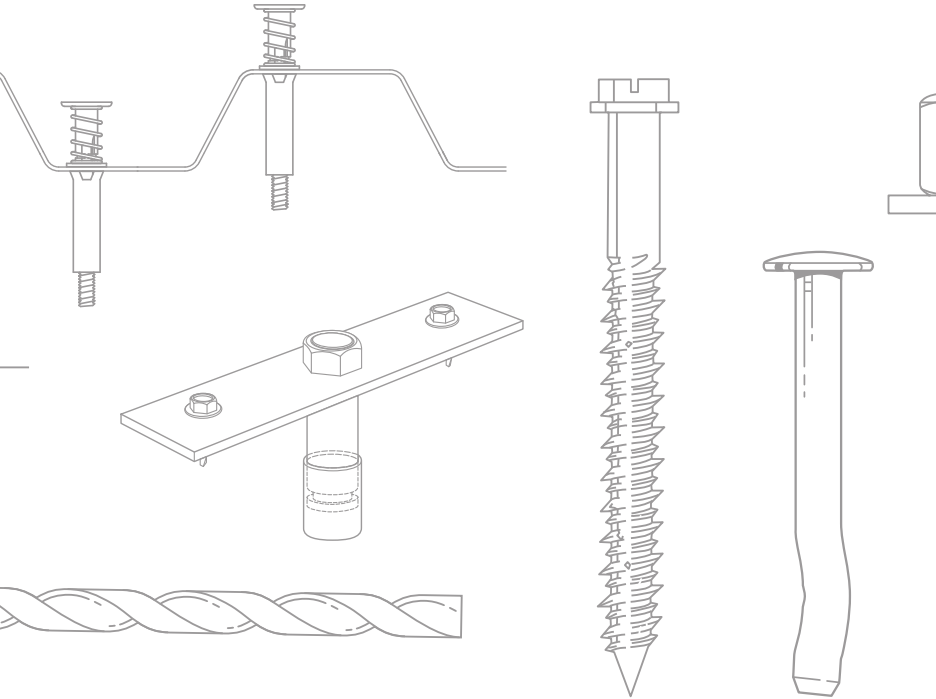

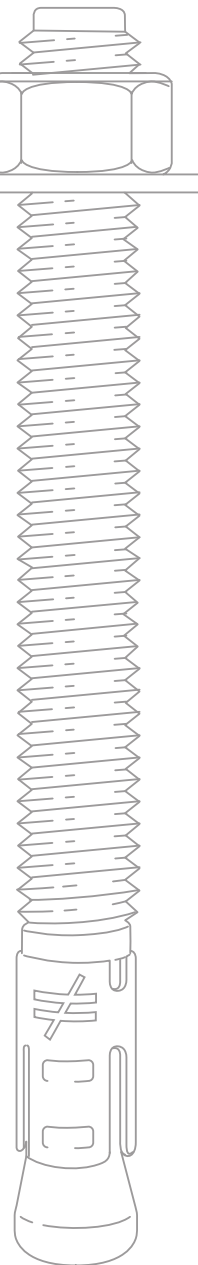

Anchoring and Fastening Applications by Market	Page
Concrete and Masonry	160–161
Commercial Drywall / Acoustical Ceiling	162–163
Curtainwall, Glazing and Cladding	164–165
Mechanical, Electrical and Plumbing	166–167
Highway and Bridge	168–169
Manufacturing, Maintenance and Material Handling	170–171
Structural and Miscellaneous Steel	172–173
Water and Sewage Treatment	174–175
Wood Construction	176–177
Concrete Repair/Restoration	178–179
Specialty Applications	180–181
Adhesive Anchoring Installation Instructions	182–189
Mechanical Anchoring Installation Instructions	190–213
Crack Injection	214–222
Length Identification Head Marks	223
Acceptable Hole Diameter	224–227
Glossary	228–231



Concrete and Masonry Applications



Anchoring Adhesives



AT-XP®



SET-XP®



ET-HP®



AT



SET

Mechanical Anchors

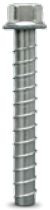

Titen HD®



Strong-Bolt® 2



Torq-Cut™



Wedge-All®



DSD
(Split Drive)



Drop-In
Anchor

Direct Fastening Systems



Gas Systems



Powder-Actuated Systems

For additional information about the above products including technical information, application information and installation instructions, reference the Simpson Strong-Tie® *Anchoring and Fastening Systems for Concrete and Masonry* catalog or visit www.strongtie.com.

Concrete and Masonry Applications

Rebar and Smooth Dowelling



Anchoring adhesives

Tilt-Up Braces



Titen HD®, Strong-Bolt® 2

Wall Dowels



Anchoring adhesives

Concrete Formwork



Coil Thread Drop-In, Titen HD, DSD, Strong-Bolt 2, Wedge-All®

Fastening Forms



Powder-actuated systems

Attaching Precast Elements



Anchoring adhesives and Strong-Bolt 2, Titen HD, Wedge-All

Anchors into Concrete Blocks



Anchoring adhesives and Strong-Bolt 2, Titen HD, Wedge-All



Note: These are general product recommendations. Final product selection must be made by a qualified engineer or installer in accordance with Simpson Strong-Tie technical information. Photos are for illustration purposes only.



Mechanical Anchors



Direct Fastening Systems



Gas Systems



Powder-Actuated Systems

Pins and Fasteners



For additional information about the above products including technical information, application information and installation instructions, reference the Simpson Strong-Tie® *Anchoring and Fastening Systems for Concrete and Masonry* catalog or visit www.strongtie.com.

Drywall Track



Direct fastening systems

Furring Strips



Titen® screw and CSD anchors,
Direct fastening systems

Ceiling Track



Direct fastening systems

Metal Furring



Direct fastening systems

Acoustical Ceiling Grid



Direct fastening systems, ceiling clips (PCLDPA, PECLDPA), Tie-Wire, Wedge-All®

Non-Top Supported Wall Braces



Strong-Bolt® 2, Titen HD®, Wedge-All



Note: These are general product recommendations. Final product selection must be made by a qualified engineer or installer in accordance with Simpson Strong-Tie technical information. Photos are for illustration purposes only.



Anchoring Adhesives



AT-XP®



SET-XP®



ET-HP®



AT



SET

Mechanical Anchors



Titen HD®



Strong-Bolt® 2



Wedge-All®



Titen® Screw



Split-Drive

Cold-Formed Steel Clips



SCB49.5

Direct Fastening Systems



Powder-Actuated Systems



PDPA Pin

For additional information about the above products including technical information, application information and installation instructions, reference the Simpson Strong-Tie® *Anchoring and Fastening Systems for Concrete and Masonry* catalog or visit www.strongtie.com.

Steel Curtain Walls



Titen HD®, Split-Drive, anchoring adhesives, direct fastening systems

Framework Mullions



Titen HD, Strong-Bolt 2, Wedge-All, direct fastening systems

Exterior Stone or Masonry Clips

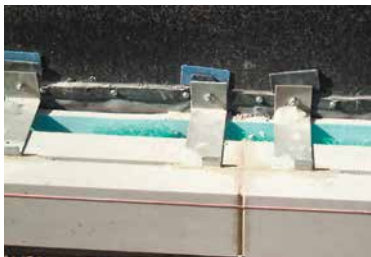

Anchoring adhesives, Strong-Bolt® 2, Wedge-All®

Masonry Veneer Ledger



Anchoring adhesives, Strong-Bolt 2, Wedge-All



Titen® screw



Note: These are general product recommendations. Final product selection must be made by a qualified engineer or installer in accordance with Simpson Strong-Tie technical information. Photos are for illustration purposes only.



Anchoring Adhesives



AT-XP®

SET-XP®

ET-HP®

AT

SET

Mechanical Anchors



Titen HD®
Rod Hanger

Titen HD®

Strong-Bolt® 2

Wedge-All®

Drop-In
Anchor

Sleeve-All

Titen®
Screw

Zinc
Nailon

Crimp
Drive®



Blue Banger Hanger®
Metal Deck Insert



Blue Banger Hanger®
Wood Form Insert



Blue Banger Hanger®
Roof Deck Insert

Direct Fastening Systems



Gas Systems



Powder-Actuated Systems

For additional information about the above products including technical information, application information and installation instructions, reference the Simpson Strong-Tie® *Anchoring and Fastening Systems for Concrete and Masonry* catalog or visit www.strongtie.com.

Junction Boxes and Breaker Panels



Titen HD®, Zinc Nailon, direct fastening systems

Transformers / Electrical Enclosures



Titen HD (interior), Strong-Bolt® 2, Wedge-All®, anchoring adhesives

Conduit Attachment



Titen® screw, Zinc Nailon, direct fastening systems

System Controls



Titen HD (interior), Strong-Bolt 2, Wedge-All, Titen screw

Cable Tray



Titen HD, Drop-In, Wedge-All, Blue Banger Hanger

Pipe Fixtures



Titen HD, Strong-Bolt 2, Wedge-All

Cable Hangers



Titen HD, Strong-Bolt 2, Wedge-All



Note: These are general product recommendations. Final product selection must be made by a qualified engineer or installer in accordance with Simpson Strong-Tie technical information. Photos are for illustration purposes only.

Highway and Bridge Applications



Anchoring Adhesives



AT-XP®

SET-XP®

ET-HP®

EDOT™

AT

SET

Mechanical Anchors



Strong-Bolt® 2

Wedge-All®

Visit www.strongtie.com/rps for more information about our new Repair, Protection and Strengthening Systems product line.



Appendix

Direct Fastening Systems



Gas Systems



Powder-Actuated Systems



PHBC Clip

For additional information about the above products including technical information, application information and installation instructions, reference the Simpson Strong-Tie® *Anchoring and Fastening Systems for Concrete and Masonry* catalog or visit www.strongtie.com.

Dowels for New or Lane Addition



Anchoring adhesives

Rebar Baskets



Direct fastening systems (PHBC clips)

Dowels for Repairs



Anchoring adhesives

Glare Screens



Strong-Bolt® 2, Wedge-All®, anchoring adhesives

Barriers and Guardrails



Anchoring adhesives

Heavy- and Light-Duty Signs



Anchoring adhesives, Strong-Bolt 2, Wedge-All

Dowels for Jersey Barriers



Anchoring adhesives



Note: These are general product recommendations. Final product selection must be made by a qualified engineer or installer in accordance with Simpson Strong-Tie technical information. Photos are for illustration purposes only.

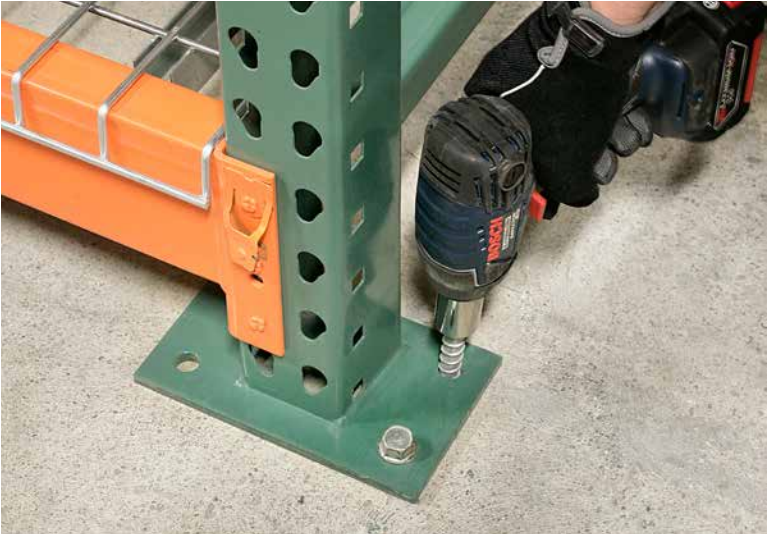

Anchoring Adhesives



AT-XP®



SET-XP®



ET-HP®



AT



SET

Mechanical Anchors



Torq-Cut®



Titen HD®



Strong-Bolt® 2



Wedge-All®



Titen® Screw

For additional information about the above products including technical information, application information and installation instructions, reference the Simpson Strong-Tie® *Anchoring and Fastening Systems for Concrete and Masonry* catalog or visit www.strongtie.com.

Machinery and Equipment Mounting



Anchoring adhesives, Strong-Bolt® 2, Wedge-All®, Torq-Cut®

Dock Doors and Bumpers



Anchoring adhesives, Titen HD® (interior), Strong-Bolt 2, Wedge-All

Control Stations and Electrical



Titen HD, Strong-Bolt 2, Wedge-All, Titen® screws

Overhead Doors



Anchoring adhesives, Titen HD, Strong-Bolt 2, Wedge-All

Conveyors and Rollers



Anchoring adhesives, Strong-Bolt 2, Wedge-All, Torq-Cut

Racking



Titen HD, Strong-Bolt 2, Wedge-All, Torq-Cut

Security Cage and Shelving



Titen HD, Strong-Bolt 2, Wedge-All



Note: These are general product recommendations. Final product selection must be made by a qualified engineer or installer in accordance with Simpson Strong-Tie technical information. Photos are for illustration purposes only.



Anchoring Adhesives



AT-XP®



SET-XP®



ET-HP®



AT



SET

Mechanical Anchors



Titen HD®



Strong-Bolt® 2



Torq-Cut™



Wedge-All®

For additional information about the above products including technical information, application information and installation instructions, reference the Simpson Strong-Tie® *Anchoring and Fastening Systems for Concrete and Masonry* catalog or visit www.strongtie.com.

Steel Beams / Columns



Anchoring adhesives, Titen HD®, Strong-Bolt® 2, Wedge-All®, Torq-Cut™

Exterior Stairs and Ladders



Strong-Bolt 2, Wedge-All

Awnings



Anchoring adhesives, Strong-Bolt 2, Wedge-All

Interior Stairs



Anchoring adhesives, Titen HD, Strong-Bolt 2, Wedge-All, Torq-Cut

Hand Railings and Access Ladders



Anchoring adhesives, Strong-Bolt 2, Wedge-All

Ornamental Iron



Anchoring adhesives, Strong-Bolt 2, Wedge-All

Protective Railing and Fencing



Titen HD (interior), Strong-Bolt 2, Wedge-All



Note: These are general product recommendations. Final product selection must be made by a qualified engineer or installer in accordance with Simpson Strong-Tie technical information. Photos are for illustration purposes only.

Water and Sewage Treatment Applications



Anchoring Adhesives



AT-XP®



SET-XP®



ET-HP®



AT



SET

Mechanical Anchors



Titen HD®



Strong-Bolt® 2



Wedge-All®



Drop-In Anchor



Blue Banger Hanger®
Wood Form Insert

For additional information about the above products including technical information, application information and installation instructions, reference the Simpson Strong-Tie® *Anchoring and Fastening Systems for Concrete and Masonry* catalog or visit www.strongtie.com.

Covers and Domes



Anchoring adhesives, Strong-Bolt® 2, Wedge-All®

Pumps and Equipment



Anchoring adhesives, Titen HD® (interior), Strong-Bolt 2, Wedge-All

Railings and Ladders



Titen HD (interior), Strong-Bolt 2, Wedge-All,

Instrumentation and Controls



Titen HD (interior), Strong-Bolt 2, Wedge-All

Gates



Anchoring adhesives, Strong-Bolt 2, Wedge-All

Elevated Walkways



Titen HD (interior), Strong-Bolt 2, Wedge-All

Pipe Supports



Drop-In, Strong-Bolt 2, Wedge-All, Blue Banger Hanger®



Note: These are general product recommendations. Final product selection must be made by a qualified engineer or installer in accordance with Simpson Strong-Tie technical information. Photos are for illustration purposes only.

Wood Construction Applications



Anchoring Adhesives



AT-XP®



SET-XP®



ET-HP®



AT



SET

Mechanical Anchors



Titen HD®



Strong-Bolt® 2



Wedge-All®

Powder-Actuated Fastening Systems



Powder-Actuated Systems



PDPALW



PDPAS

For additional information about the above products including technical information, application information and installation instructions, reference the Simpson Strong-Tie® *Anchoring and Fastening Systems for Concrete and Masonry* catalog or visit www.strongtie.com.

Wood Construction Applications

Perimeter Mudsills



Anchoring adhesives, Titen HD[®], powder-actuated systems

Framing Hardware (new and retrofit)



Anchoring adhesives, Titen HD, Strong-Bolt[®] 2, Wedge-All[®]

Ledgers



Anchoring adhesives, Titen HD (interior only), Strong-Bolt 2, Wedge-All

Structural Beams



Anchoring adhesives, Strong-Bolt 2, Wedge-All

Post Bases for Decks, Railings and Patio Covers



Anchoring adhesives, Strong-Bolt 2, Wedge-All



Note: These are general product recommendations. Final product selection must be made by a qualified engineer or installer in accordance with Simpson Strong-Tie technical information. Photos are for illustration purposes only.

Concrete Repair / Restoration Applications



Crack Injection Adhesives



ETI-SLV



ETI-LV



ETI-GV



Crack-Pac®



Crack-Pac® Flex-H₂O™



ETR-16



CIP-F

For additional information about the above products including technical information, application information and installation instructions, reference the Simpson Strong-Tie® *Anchoring and Fastening Systems for Concrete and Masonry* catalog or visit www.strongtie.com.

Crack injection in concrete slabs and walls to stop moisture



Dry cracks: ETI-SLV, ETI-LV, ETI-GV, Crack-Pac®, Crack-Pac® Flex-H₂O™
Wet/leaking cracks: ETI-SLV, ETI-LV, ETI-GV, Crack-Pac Flex-H₂O

Gravity feed for cracks in floors



ETI-SLV, ETI-LV, ETI-GV, Crack-Pac, Crack-Pac Flex-H₂O

Crack injection in concrete slabs, walls, columns and beams to restore structural integrity



ETI-SLV, ETI-LV, ETI-GV

Dowels to reinforce replaced concrete



Anchoring adhesives

Crack injection in swimming pools



ETI-SLV, ETI-LV, ETI-GV, Crack-Pac, Crack-Pac Flex-H₂O



Note: These are general product recommendations. Final product selection must be made by a qualified engineer or installer in accordance with Simpson Strong-Tie technical information. Photos are for illustration purposes only.

Visit www.strongtie.com/rps for more information about our new Repair, Protection and Strengthening Systems product line.



Specialty Applications



Anchoring Adhesives



AT-XP®



SET-XP®



ET-HP®



AT



SET

Mechanical Anchors



Heli-Tie™

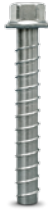

Titen HD®



Strong-Bolt® 2



Torq-Cut™



Wedge-All®



Titen® Screw

Direct Fastening Systems



Gas Systems



Powder-Actuated Systems

For additional information about the above products including technical information, application information and installation instructions, reference the Simpson Strong-Tie® *Anchoring and Fastening Systems for Concrete and Masonry* catalog or visit www.strongtie.com.

Specialty Applications

Stadium Seating



Anchoring adhesives, Strong-Bolt® 2, Titen HD® (interior), Wedge-All®

Basement Wrap / Waterproofing



Direct fastening systems (GDP, GDPS, PDPA pins)

Rail Anchoring



Anchoring adhesives

Architectural Features



Anchoring adhesives, Strong-Bolt 2, Titen HD (interior only), Wedge-All, Titen® screw

Lathing



Direct fastening systems (GDP, GWL pins)

Concrete Removal



Strong-Bolt 2, Titen HD, Wedge-All

Seismic Retrofit / Structural Renovation



Anchoring adhesives, Strong-Bolt 2, Titen HD, Wedge-All, Torq-Cut™



Note: These are general product recommendations. Final product selection must be made by a qualified engineer or installer in accordance with Simpson Strong-Tie technical information. Photos are for illustration purposes only.

Adhesive Anchoring Installation Instructions



NOTE: Always check expiration date on product label. Do not use expired product.



WARNING: When drilling and cleaning hole, use eye and lung protection. When installing adhesive, use eye and skin protection.

1 Hole Preparation – Horizontal, Vertical and Overhead Applications

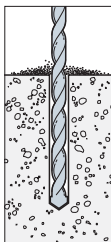

1. Drill.
Drill hole to specified diameter and depth.

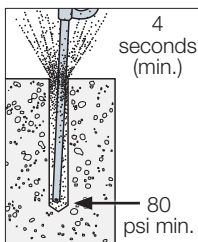

2. Blow.
Remove dust from hole with oil-free compressed air for a minimum of 4 seconds. Compressed air nozzle must reach the bottom of the hole.

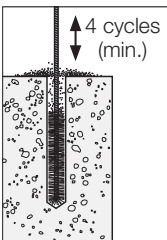

3. Brush.
Clean with a nylon brush for a minimum of 4 cycles. Brush should provide resistance to insertion. If no resistance is felt, the brush is worn and must be replaced.

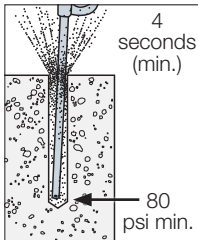

4. Blow.
Remove dust from hole with oil-free compressed air for a minimum of 4 seconds. Compressed air nozzle must reach the bottom of the hole.

Refer to page 32 or visit www.strongtie.com for proper brush part number.

2 Cartridge Preparation

1. Check.

Check expiration date on product label. **Do not use expired product.** Product is usable until end of printed expiration month.

Refer to www.strongtie.com for proper mixing nozzle and dispensing tool part number.

2. Open.

Open cartridge per package instructions.

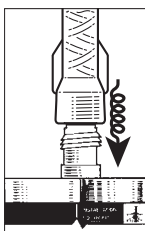

3. Attach.

Attach proper Simpson Strong-Tie® nozzle and extension to cartridge. Do not modify nozzle.

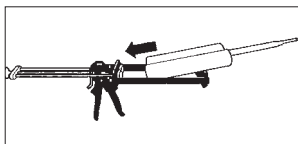

4. Insert.

Insert cartridge into dispensing tool.

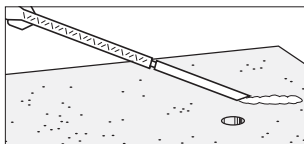

5. Dispense.

Dispense adhesive to the side until properly mixed (uniform color).

FOR SOLID BASE MATERIALS

3A Filling the Hole – Vertical Anchorage

Prepare the hole per “Hole Preparation” instructions on product label.

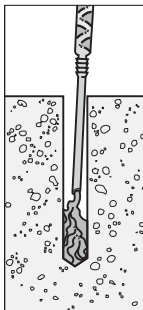
DRY AND DAMP HOLES:**1. Fill.**

Fill hole $\frac{1}{2}$ to $\frac{2}{3}$ full, starting from bottom of hole to prevent air pockets. Withdraw nozzle as hole fills up.

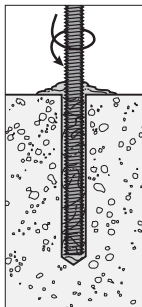
**2. Insert.**

Insert clean, oil-free anchor, turning slowly until the anchor contacts the bottom of the hole.

Threaded rod or rebar

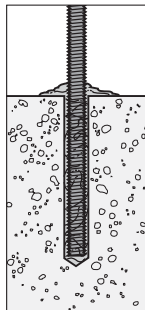
**3. Do not disturb.**

Do not disturb anchor until fully cured. (See cure schedule for specific adhesive.)

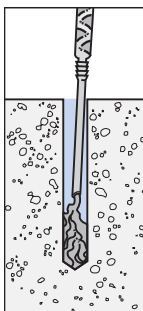
WATER-FILLED HOLES:**1. Fill.**

Fill hole completely full, starting from bottom of hole to prevent water pockets. Withdraw nozzle as hole fills up.

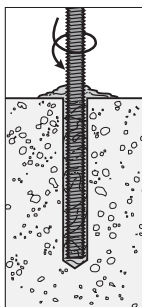
**2. Insert.**

Insert clean, oil-free anchor, turning slowly until the anchor contacts the bottom of the hole.

Threaded rod or rebar

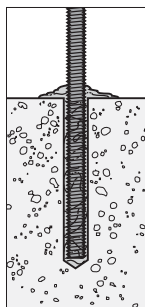
**3. Do not disturb.**

Do not disturb anchor until fully cured. (See cure schedule.)

Note: Nozzle extensions may be needed for deep holes.

Adhesive Anchoring Installation Instructions

3B Filling the Hole – Piston Plug Delivery System

Prepare the hole per "Hole Preparation" instructions on product label.

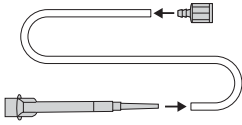

Step 1:

- Attach the piston plug to one end of the flexible tubing (PPFT25).
- Cut tubing to the length needed for the application, mark tubing as noted at right and attach other end of tubing to the mixing nozzle.
- If using a pneumatic dispensing tool, regulate air pressure to 80–100 psi.

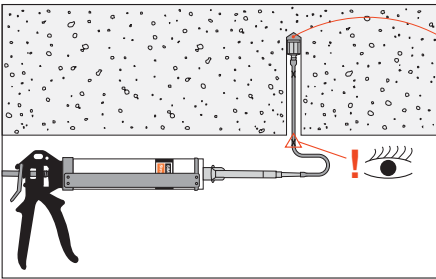
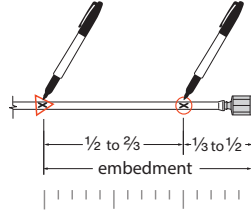

Step 2:

- Insert the piston plug to the back of the drilled hole and dispense adhesive.

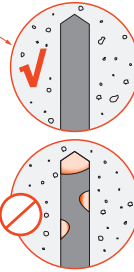
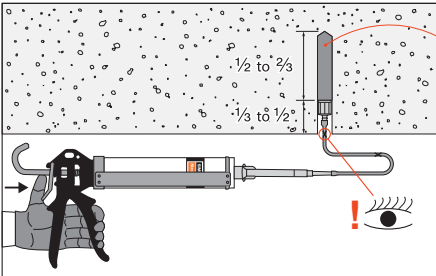

Step 3:

- Fill the hole $\frac{1}{2}$ to $\frac{2}{3}$ full.
- **Note:** as adhesive is dispensed into the drilled hole, the piston plug will slowly displace out of the hole due to back pressure, preventing air gaps.

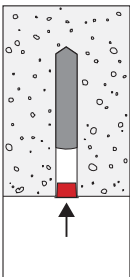

Step 4:

- Install the appropriate Simpson Strong-Tie adhesive retaining cap.

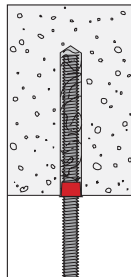

Step 5:

- Place either threaded rod or rebar through the adhesive retaining cap and into adhesive-filled hole.
- Turn rod/rebar slowly until the insert bottoms out.
- Do not disturb until fully cured.

Adhesive Anchoring Installation Instructions

3C Filling the Hole – Horizontal and Overhead Anchorage with Adhesive Retaining Caps

Prepare the hole per "Hole Preparation" instructions on product label.

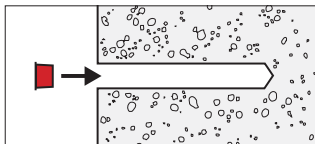
**1. Install.**

Install Simpson Strong-Tie® ARC adhesive retaining cap. Refer to page 28 or visit www.strongtie.com for proper ARC size.

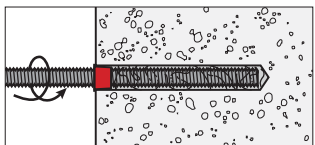
Threaded rod or rebar**3. Insert.**

Insert clean, oil-free anchor, turning slowly until the anchor contacts the bottom of the hole.

Note: Nozzle extensions may be needed for deep holes.

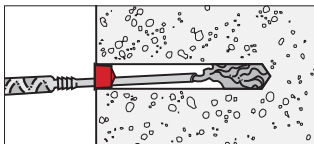
**2. Fill.**

Fill hole 1/2–2/3 full, starting from bottom of hole to prevent air pockets. Withdraw nozzle as hole fills up.

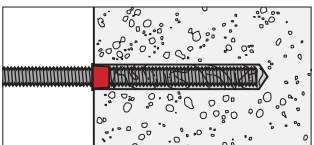
Threaded rod or rebar**4. Do not disturb.**

Do not disturb anchor until fully cured (see cure schedule).

FOR HOLLOW BASE MATERIALS

3D Filling the Hole – When Anchoring with Screens: For AT, ET-HP®, SET-XP® and SET Adhesives (except SET1.7KTA)

Prepare the hole per instructions on "Hole Preparation."

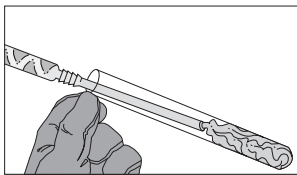
**1. Fill.**

Fill screen completely. Fill from the bottom of the screen and withdraw the nozzle as the screen fills to prevent air pockets. (Opt-Mesh screens: Close integral cap after filling.)

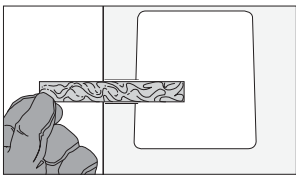
**2. Insert.**

Insert adhesive-filled screen into hole.

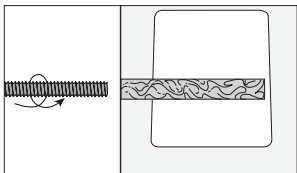
**3. Insert.**

Insert clean, oil-free anchor, turning slowly until the anchor contacts the bottom of the screen.

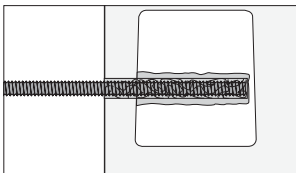
**4. Do not disturb.**

Do not disturb anchor until fully cured. (See cure schedule for specific adhesive.)

Installation instructions continued on page 186. →

Adhesive Anchoring Installation Instructions

FOR UNREINFORCED BRICK MASONRY

- 1A** **Hole Preparation** – For Configurations A and C (Horizontal) and B (22½-Degree Downward) Installations with a Carbide-Tipped Drill Bit.

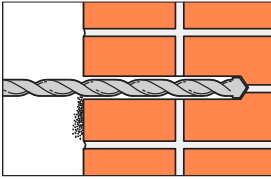
**1. Drill.**

Drill 1-inch-diameter hole to specified depth with a carbide-tipped drill bit, using rotation-only mode. For Configurations A and C, drill 8 inches deep. For Configuration B, drill to within 1 inch of the opposite side of wall (minimum 13 inches deep).

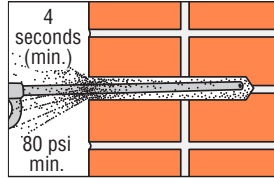
**2. Blow.**

Remove dust from hole with oil-free compressed air for a minimum of 4 seconds. Compressed air nozzle MUST reach the bottom of the hole.

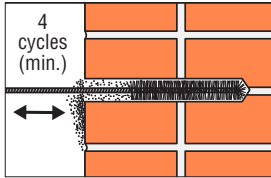
**3. Brush.**

Clean with a nylon brush for a minimum of 4 cycles. Brush MUST reach the bottom of the hole. Brush should provide resistance to insertion. If no resistance is felt, the brush is worn and must be replaced.

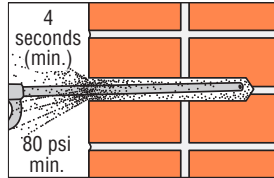
**4. Blow.**

Remove dust from hole with oil-free compressed air for a minimum of 4 seconds. Compressed air nozzle MUST reach the bottom of the hole.

- 1B** **Hole Preparation** – For using SET Adhesive Configurations A and C (Horizontal) and B (22½-Degree Downward) Installations with a Wet Diamond Core-Drill Bit.

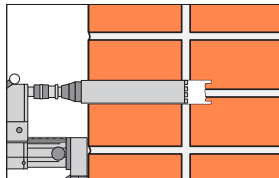
**1. Drill.**

Drill hole to specified depth with 1-inch-diameter wet diamond core-drill bit. For Configurations A and C, drill 8 inches deep. For Configuration B, drill to within 1 inch of the opposite side of wall (minimum 13 inches deep).

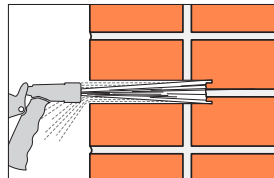
**2. Flush.**

Flush out hole with pressurized water until water runs clear.

Adhesive Anchoring Installation Instructions

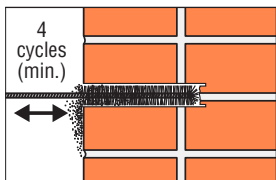
1B Hole Preparation (cont.)**3. Brush.**

Clean with a nylon brush (Simpson Strong-Tie part number ETB10) for a minimum of 4 brush strokes. Brush **MUST** reach the bottom of the hole. Brush should provide resistance to insertion. If no resistance is felt, the brush is worn and must be replaced.

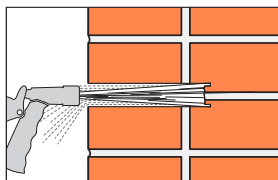
**4. Flush.**

Flush out hole with pressurized water until water runs clear.

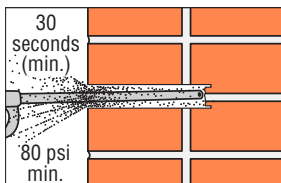
**5. Blow.**

Remove free standing water from hole with oil-free compressed air and blow out hole for a minimum of 30 seconds. Compressed air nozzle **MUST** reach the bottom of the hole.

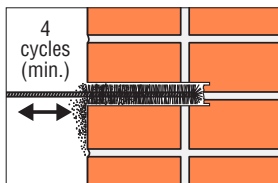
**6. Brush.**

Clean with a nylon brush (Simpson Strong-Tie part number ETB10) for a minimum of 4 brush strokes. Brush **MUST** reach the bottom of the hole. Brush should provide resistance to insertion. If no resistance is felt, the brush is worn and must be replaced.

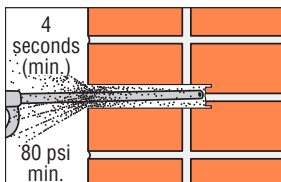
**7. Blow.**

Blow hole with oil-free compressed air for a minimum of 4 seconds. Compressed air nozzle **MUST** reach the bottom of the hole.

Adhesive Anchoring Installation Instructions

2 Cartridge Preparation**1. Check.**

Check cartridge expiration date. **Do not use expired product.** Product is usable until end of printed expiration month.

2. Open.

Open cartridge per package instructions.

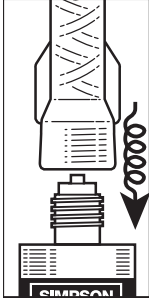
**3. Attach.**

Attach proper Simpson Strong-Tie® nozzle to cartridge. Do not modify nozzle.

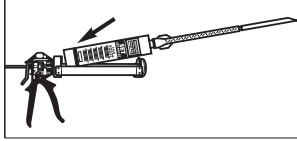
**4. Insert.**

Insert cartridge into dispensing tool.

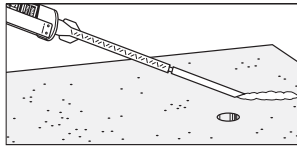
**5. Dispense.**

Dispense adhesive to the side until properly mixed (uniform color).

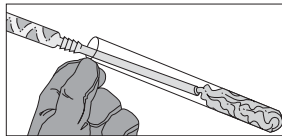
3A Filling the Hole – For Configurations A (Horizontal) and B (22½-Degree Downward) Installations**1. Fill.**

Fill screen completely. Fill from the bottom of the screen and withdraw the nozzle as the screen fills to prevent air pockets. (Opti-Mesh screens: Close integral cap after filling.)

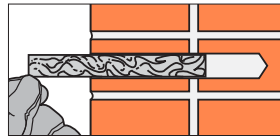
**2. Insert.**

Insert adhesive-filled screen into hole.

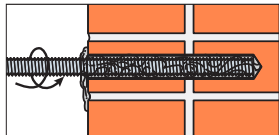
**3. Insert.**

Insert clean, oil-free anchor, turning slowly until the anchor contacts the bottom of the screen.

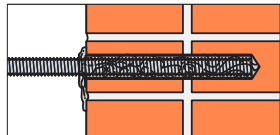
**4. Do not disturb.**

Do not disturb anchor until fully cured. (See cure schedule for specific adhesive.)

Note: Opti-Mesh plastic screens or steel wire mesh screens may be used for Configurations A and B.

Adhesive Anchoring Installation Instructions

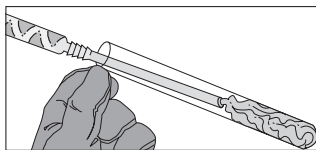
3B Filling the Hole – For Configuration C (Horizontal Through-Bolt) Installation**1. Fill.**

Fill screen completely. Fill from the bottom of the screen and withdraw the nozzle as the screen fills to prevent air pockets.

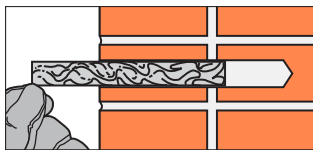
**2. Insert.**

Insert adhesive-filled screen into hole.

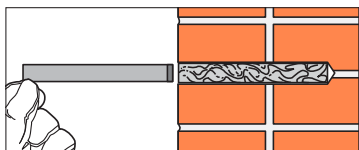
**3. Insert.**

Insert steel sleeve (capped end first) slowly into screen tube (adhesive will displace).

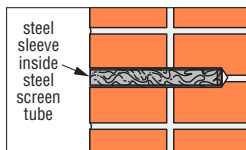
**4. Cure.**

Allow adhesive to cure (see Cure Time Table 1).

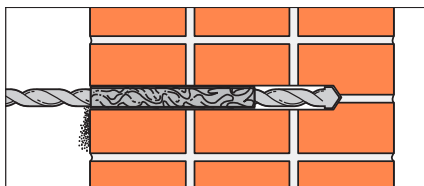
**5. Drill.**

Drill through plastic plug in (inside) end of steel sleeve and completely through the wall with $\frac{5}{8}$ " carbide tipped concrete drill bit (rotation mode only).

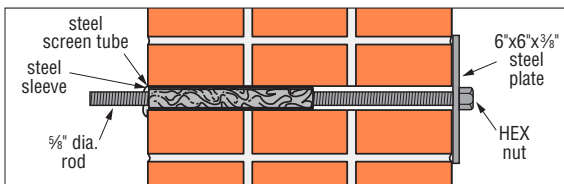
**6. Insert.**

Insert $\frac{5}{8}$ " rod through hole and attach metal plate and nut.

Note: Steel wire mesh screens shall be used for Configuration C.

Torq-Cut™ Self-Undercutting Anchor

Installation Instructions: Pre-Set Version

1. Drill a hole in the base material to the specified embedment depth using the appropriate diameter carbide drill bit specified for each diameter.
2. Blow the hole clean using compressed air.
3. Assemble the anchor with nut and washer, and finger-tighten the nut so all components are snug (spacer sleeve, expansion sleeve and cone). The bottom of the threaded rod should be flush with the bottom of the cone.
4. Place the anchor in the drilled hole, and use a hammer and setting tool to drive the anchor until the washer and nut are tight against the surface of the base material.
5. Remove the nut and washer and install the fixture. Reassemble the nut and washer over the fixture.
6. Tighten to the required installation torque.

Installation Instructions: Through-Set Version

1. Drill a hole in the base material to the specified embedment depth using the appropriate diameter carbide drill bit specified for each diameter.
2. Blow the hole clean using compressed air.
3. Assemble the anchor with nut and washer and finger-tighten the nut so all components are snug (spacer sleeve, expansion sleeve and cone). The bottom of the threaded rod should be flush with the bottom of the cone.
4. Place the anchor through the fixture and into the drilled hole. Use a hammer and setting tool to drive the anchor until the washer and nut are tight against the fixture.
5. Tighten to the required installation torque.



Caution: Oversized holes in the base material will make it difficult to set the anchor and will reduce the anchor's load capacity. Do not install in holes drilled with core drill bit.

Pre-Set and Through-Set Version

Step 1

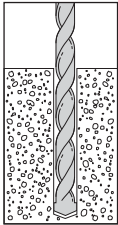

2

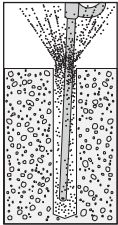

3

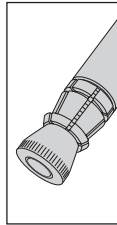
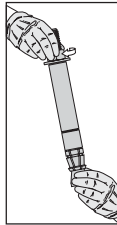

Pre-Set Version

Step 4

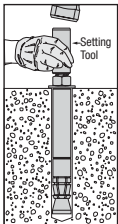

5

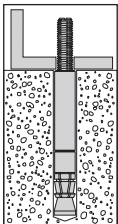

6

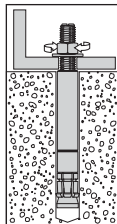

Through-Set Version

Step 4

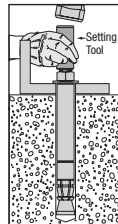

5

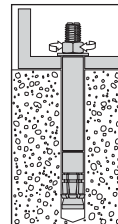

Strong-Bolt® 2 Wedge Anchor**Installation Instructions:**

Do not use an impact wrench to set or tighten the Strong-Bolt® 2 anchor.



Caution: Oversized holes in the base material will make it difficult to set the anchor and will reduce the anchor's load capacity.

1. Drill a hole in the base material using a carbide drill bit the same diameter as the nominal diameter of the anchor to be installed. Drill the hole to the specified minimum hole depth, and blow it clean using compressed air. (Overhead installations need not be blown clean.) Alternatively, drill the hole deep enough to accommodate embedment depth and dust from drilling.
2. Assemble the anchor with nut and washer so the top of the nut is flush with the top of the anchor. Place the anchor in the fixture, and drive it into the hole until the washer and nut are tight against the fixture.
3. Tighten to the required installation torque.

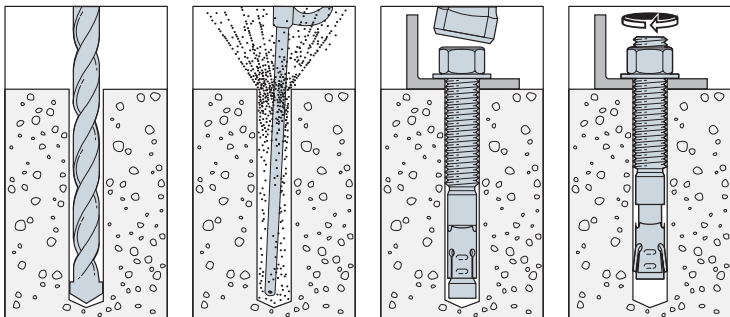
Installation Sequence

Wedge-All® Wedge Anchor

Installation Instructions:



Do not use an impact wrench to set or tighten anchors.



Caution: Oversized holes in the base material will make it difficult to set the anchor and will reduce the anchor's load capacity.

1. Drill a hole in base material using a carbide drill bit the same diameter as the nominal diameter of the anchor to be installed. Drill the hole to the specified embedment depth, and blow it clean using compressed air. (Overhead installations need not be blown clean.) Alternatively, drill the hole deep enough to accommodate the embedment depth and the dust from drilling.
2. Assemble the anchor with nut and washer so the top of the nut is flush with the top of the anchor. Place the anchor in the fixture, and drive it into the hole until the washer and nut are tight against the fixture.
3. Tighten to the required installation torque.

Installation Sequence

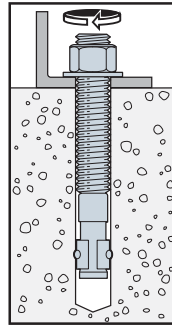
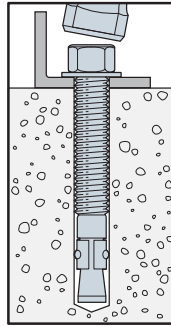
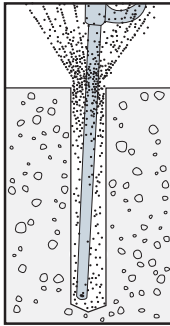
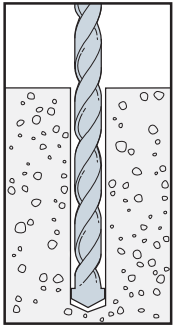

Tie-Wire Wedge Anchor

Installation Instructions:

1. Drill a hole at least 1 1/2" deep using a 1/4"-diameter carbide tipped bit.
2. Drive the anchor into the hole until the bottom of the head is flush with the base material.
3. Set the anchor by prying/pulling the head with the claw end of the hammer.

Installation Sequence

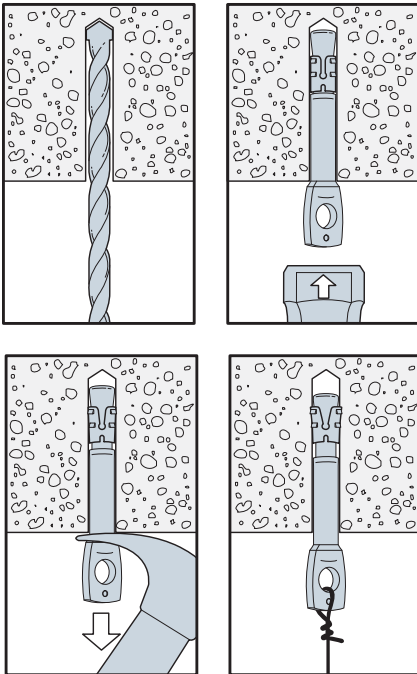

Easy-Set Pin-Drive Expansion Anchor

Installation Instructions:



Caution: Oversized holes in the base material will make it difficult to set the anchor and will reduce the anchor's load capacity.

1. Drill a hole in the base material using a carbide drill bit the same diameter as the nominal diameter of the anchor to be installed. Drill the hole to the specified embedment depth plus $\frac{1}{4}$ " to allow for pin extension and blow it clean using compressed air. (Overhead installations need not be blown clean.) Alternatively, drill the hole deep enough to accommodate embedment depth and the dust from drilling.
2. Adjust the nut for required embedment. Place the anchor through the fixture and into the hole.
3. Hammer the center pin until the bottom of the head is flush with top of anchor.

Installation Sequence

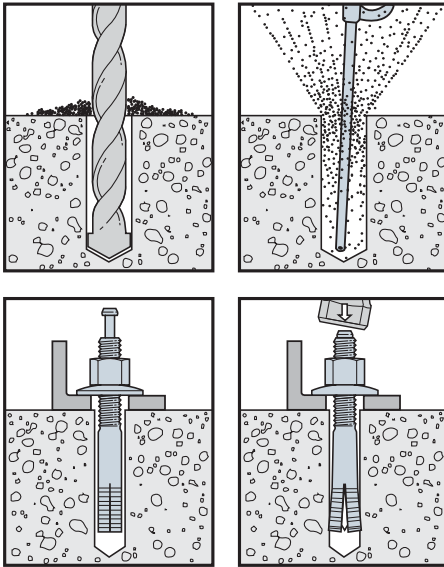

Sleeve-All® Sleeve Anchor

Installation Instructions:

1. Drill a hole in the base material using a carbide drill bit the same diameter as the nominal diameter of the anchor to be installed.
2. Drill the hole to the specified embedment depth, and blow it clean using compressed air. (Overhead installations need not be blown clean.) Alternatively, drill the hole deep enough to accommodate embedment depth and the dust from drilling.
3. Place the anchor in the fixture, and drive it into the hole until the washer and nut are tight against the fixture.
4. Tighten to required installation torque.



Caution: Oversized holes will make it difficult to set the anchor and will reduce the anchor's load capacity.

Installation Sequence

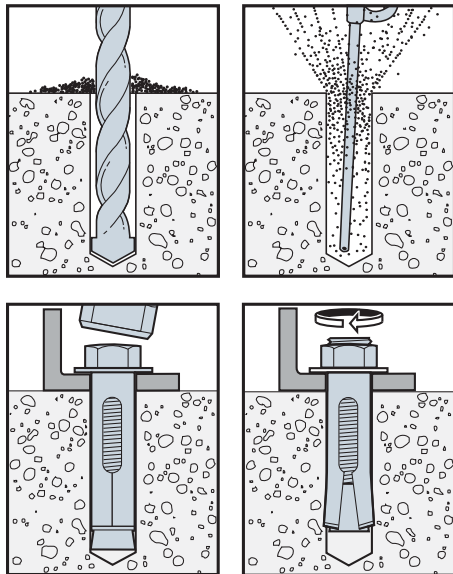

Titen HD® Heavy-Duty Screw Anchor

Installation Instructions:



Holes in metal fixtures to be mounted should match the diameter specified in the table below.

Use a Titen HD® screw anchor one time only — installing the anchor multiple times may result in excessive thread wear and reduce load capacity.



Do not use impact wrenches to install into hollow CMU.



Caution: Oversized holes in base material will reduce or eliminate the mechanical interlock of the threads with the base material and reduce the anchor's load capacity.

1. Drill a hole in the base material using a carbide drill bit the same diameter as the nominal diameter of the anchor to be installed. Drill the hole to the specified embedment depth plus minimum hole depth overall (see table below right) to allow the thread tapping dust to settle, and blow it clean using compressed air. (Overhead installations need not be blown clean.) Alternatively, drill the hole deep enough to accommodate embedment depth and the dust from drilling and tapping.
2. Insert the anchor through the fixture and into the hole.
3. Tighten the anchor into the base material until the hex-washer head contacts the fixture.

Installation Sequence

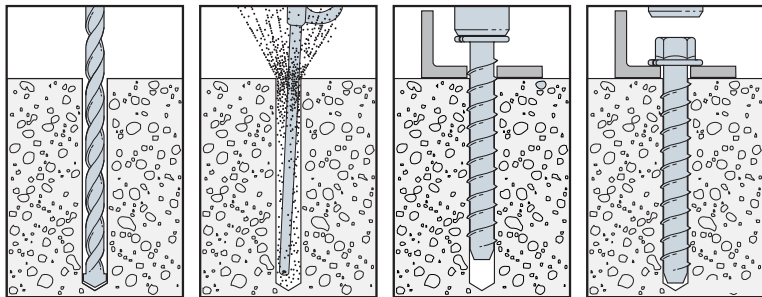

Titen HD® Rod Coupler

Installation Instructions:



Caution: Oversized holes in the base material will reduce or eliminate the mechanical interlock of the threads with the base material and will reduce the anchor's load capacity. Use a Titen HD® Rod Coupler one time only. Installing the anchor multiple times may result in excessive thread wear and reduce load capacity.

1. Drill a hole using the specified diameter carbide bit into the base material to a depth of at least $\frac{1}{2}$ " deeper than the required embedment.
2. Blow the hole clean of dust and debris using compressed air. Overhead installations need not be blown clean.
3. Tighten the anchor with appropriate size socket until the head sits flush against base material.

Installation Sequence

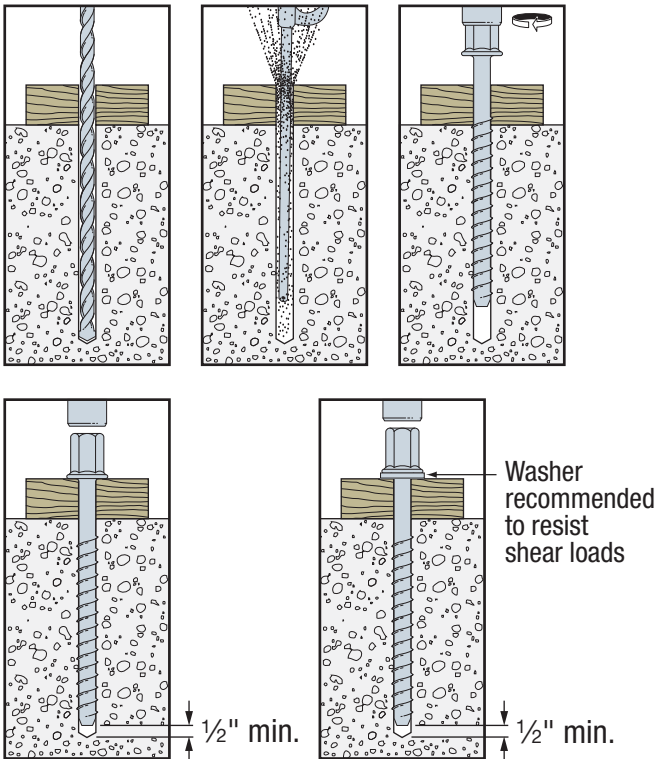

Titen® Concrete and Masonry Screw

Installation Instructions:



Caution: Industry studies show that hardened fasteners can experience performance problems in wet or corrosive environments. Steps must be taken to prevent inadvertent sustained loads above the listed allowable loads. Overtightening and bending moments can initiate cracks detrimental to the hardened screw's performance. Use the Simpson Strong-Tie installation tool kit. It is designed to reduce the potential for overtightening the screw.

Caution: Oversized holes in the base material will reduce or eliminate the mechanical interlock of the threads with the base material and will reduce the anchor's load capacity.

1. Drill a hole in the base material using the appropriate diameter carbide drill bit as specified in the table. Drill the hole to the specified embedment depth plus $\frac{1}{2}$ " to allow the thread tapping dust to settle and blow it clean using compressed air. (Overhead installations need not be blown clean.) Alternatively, drill the hole deep enough to accommodate embedment depth and dust from drilling and tapping.
2. Position fixture, insert screw and tighten using drill and installation tool fitted with a hex socket or Phillips bit.

Preservative-treated wood applications: suitable for use in non-ammonia formulations of CCA, ACQ-C, ACQ-D, CA-B, BX/DOT and zinc borate. Use in dry, interior environments only.

Use caution not to damage ceramic barrier coating during installation. Recommendations are based on testing and experience at time of publication and may change. Simpson Strong-Tie cannot provide estimates on service life of screws.

Installation Sequence

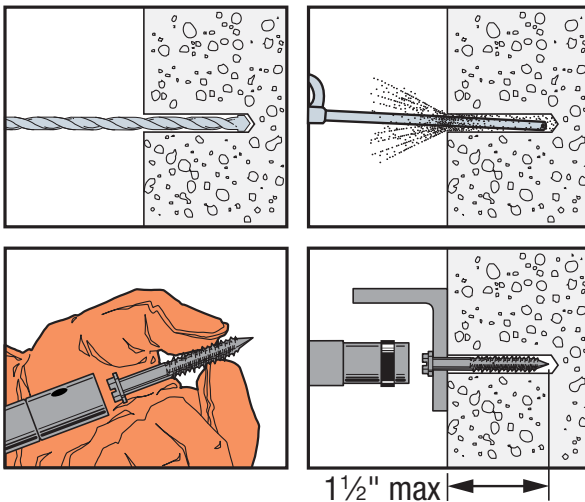

Titen HD® Threaded Rod Hanger

Installation Instructions:



Caution: Oversized holes in the base material will reduce or eliminate the mechanical interlock of the threads with the base material and will reduce the anchor's load capacity.



Caution: Use a Titen HD® Rod Hanger one time only. Installing the anchor multiple times may result in excessive thread wear and reduce load capacity.

1. Drill a hole using the specified diameter carbide bit into the base material to a depth of at least $\frac{1}{2}$ " deeper than the required embedment.
2. Blow the hole clean of dust and debris using compressed air.
3. **IMPORTANT:** Install with an applied torque of 15 ft-lb for the THD25112RH and THD37218RH rod hangers using a torque wrench, driver drill, hammer drill or cordless $\frac{1}{4}$ " impact driver with a maximum permitted torque rating of 100 ft-lb.

Installation Sequence

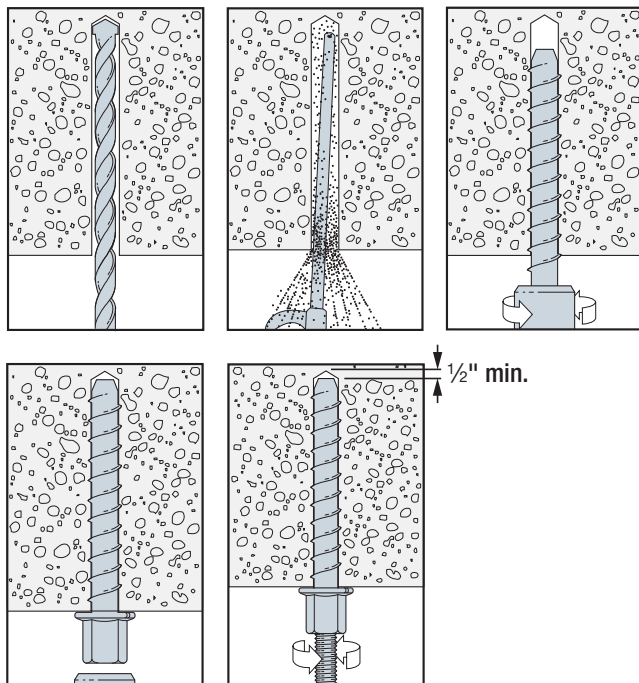

Wood Rod Hanger Threaded Rod Anchor System

Installation Instructions:

1. Attach RND62 nut driver to a drill.
2. Insert rod hanger into the RND62 nut driver.
3. Using rotation-only mode, drive rod hanger until it contacts the surface. Do not over-tighten. RND62 nut driver will disengage the rod hanger at the appropriate depth to prevent over-driving.
4. Insert threaded rod. Minimum thread engagement should be equal to the nominal diameter of the threaded insert.

Installation Sequence

Vertical Wood Rod Hanger

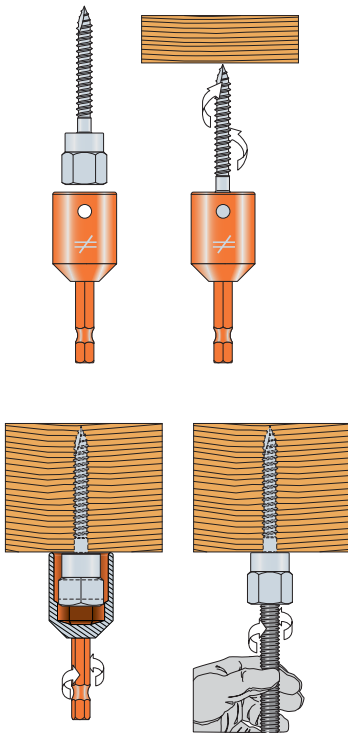

Installation Sequence

Horizontal Wood Rod Hanger

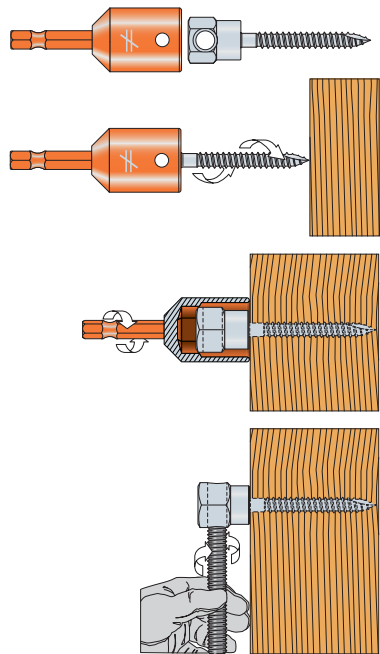

Wood-Form Insert

Installation Instructions:

1. Strike the top of the hanger and drive the three mounting nails into the forming material until the bottom of the hanger is flush with the bottom of the plywood. The hanger should be sitting 90° from the forming material.
2. Once concrete is hardened and forms are stripped, strike the mounting nails to break them off.
3. Insert the rod into the sleeve and thread it into the hanger.

Installation Sequence

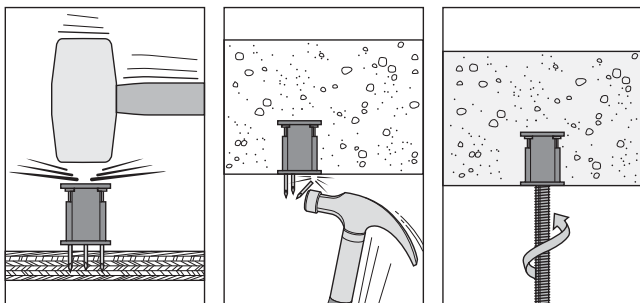

Metal-Deck Insert

Installation Instructions:

1. Drill a hole in the metal deck using the appropriate diameter bit as referenced in the table.
2. Insert the hanger in the hole and strike the top so that the plastic sleeve is forced through the hole and expands against the bottom side of the deck. The anchor can also be installed by stepping on it.
3. Insert the rod into the sleeve and thread it into the hanger.

Installation Sequence

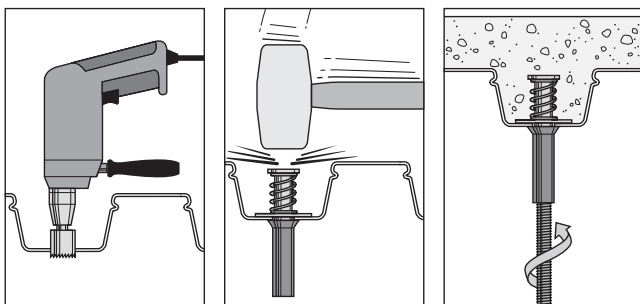

Metal-Roof-Deck Insert

Installation Instructions:

1. Drill a hole in the metal deck using the appropriate diameter bit as referenced in the table.
2. Insert the hanger into the hole and fasten to the deck with the two pre-staked screws provided.
3. Insert the rod into the sleeve and thread it into the hanger.

Installation Sequence

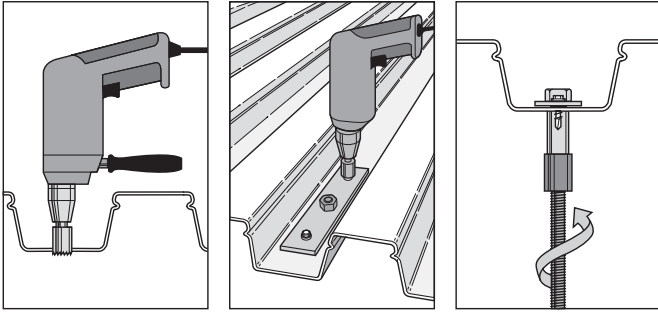

Drop-In Internally Threaded Anchor (DIAB)

DIAB Manual Installation Instructions:



Caution: Oversized holes will reduce the anchor's load capacity.

1. Drill a hole in the base material using the appropriate-diameter carbide drill bit or fixed-depth bit as specified in the table. Drill the hole to the specified embedment. For fixed-depth bits, drill the hole until the shoulder of the bit contacts the surface of the base material. Then blow the hole clean of dust and debris using compressed air. Overhead installations need not be blown clean.
2. Insert the anchor into the hole. Tap with hammer until flush against the surface.
3. Using the designated Drop-In setting tool, drive expander plug towards the bottom of the anchor until the shoulder of the setting tool makes contact with the top of the anchor. When properly set, four indentations will be visible on the top of the anchor indicating full expansion.
4. Insert bolt or threaded rod. Minimum thread engagement should be equal to the nominal diameter of the threaded insert.

Installation Sequence

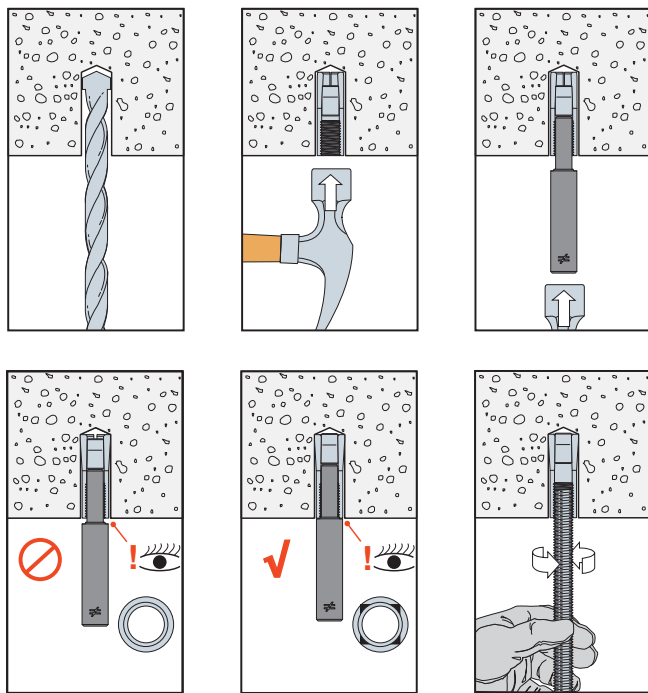

Drop-In Internally Threaded Anchor (DIAB)

DIAB SDS Installation Instructions:



Caution: Oversized holes will reduce the anchor's load capacity.

1. Drill a hole in the base material using the appropriate-diameter carbide drill bit or fixed-depth drill bit as specified in the table. Drill the hole to the specified embedment. For fixed-depth bits, drill the hole until the shoulder of the bit contacts the surface of the base material. Then blow the hole clean of dust and debris using compressed air. Overhead installations need not be blown clean.
2. Insert the anchor into the hole. Tap with hammer until flush against the surface.
3. Attach SDS Drop-In setting tool to a drill. Drive expander plug toward the bottom of the anchor using only hammer mode until the shoulder of the setting tool makes contact with the top of the anchor. When properly set, four indentations will be visible on the top of the anchor indicating full expansion.
4. Insert bolt or threaded rod. Minimum thread engagement should be equal to the nominal diameter of the threaded insert.

Installation Sequence

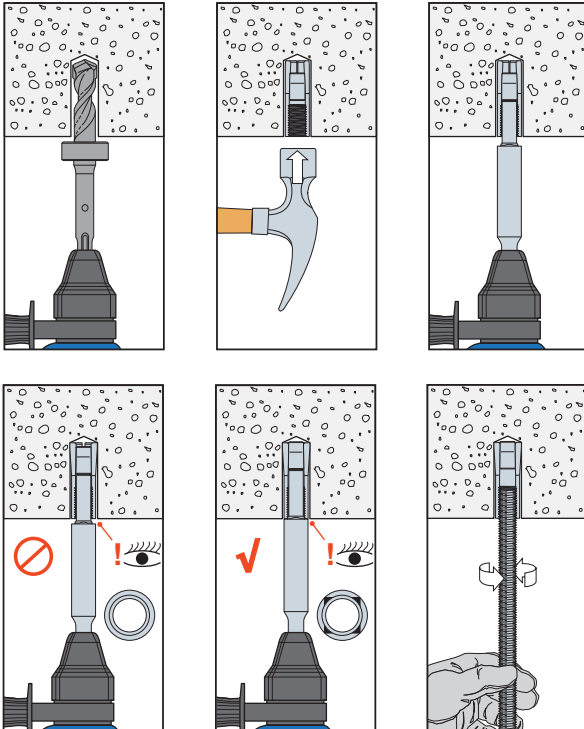

Drop-In Internally Threaded Anchor (DIA)

Installation Instructions:

1. Drill a hole in the base material using the appropriate-diameter carbide drill bit as specified in the table. Drill the hole to the specified embedment depth plus $\frac{1}{8}$ " for flush mounting. Blow the hole clean using compressed air. Overhead installations need not be blown clean.
2. Insert designated anchor into hole. Tap with hammer until flush against surface.
3. Using the designated drop-in setting tool, drive expander plug toward the bottom of the anchor until shoulder of setting tool makes contact with the top of the anchor.
4. Minimum thread engagement should be equal to the nominal diameter of the threaded insert.



Caution: Oversized holes will make it difficult to set the anchor and will reduce the anchor's load capacity.

Installation Sequence

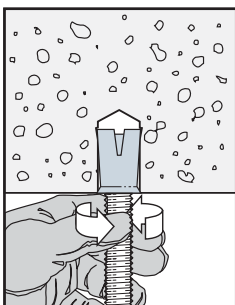
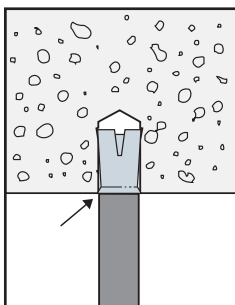
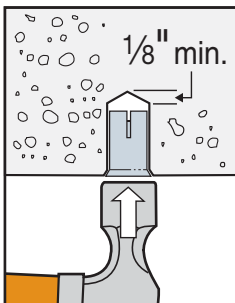
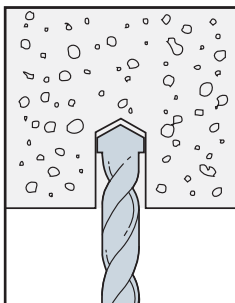

Hollow Drop-In Internally Threaded Anchor**Installation Instructions — Solid Base**
(using solid setting tool)

1. Drill a hole in the base material using the appropriate-diameter carbide drill bit as specified in the table. Drill the hole to the specified embedment depth.
2. Blow the hole clean using compressed air. Overhead installations need not be blown clean.
3. Insert the HDIA into hole. Tap with hammer until flush against surface.
4. Using the designated setting tool, drive the anchor to the bottom of the drilled hole. After the anchor reaches the bottom of the drilled hole, perform an additional three hammer blows against the setting tool to drive the anchor body over the cone.
5. Position fixture; insert fastener and tighten.

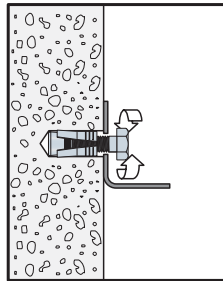
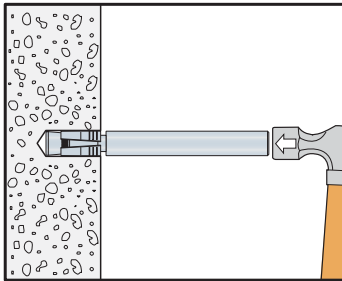
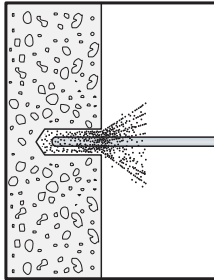
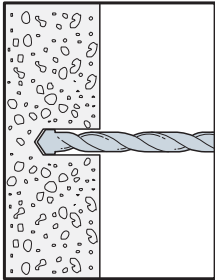
Installation Sequence

Hollow Drop-In Internally Threaded Anchor**Installation Instructions — Hollow Base**
(using hollow setting tool)

1. Drill a hole in the base material using the appropriate-diameter carbide drill bit as specified in the table.
2. Thread the HDIA onto the designated setting tool for hollow base materials.
3. Insert the HDIA into the hole. Tap the setting tool until the face of the tool contacts the surface.
4. Rotate the setting tool a minimum of two turns to set the anchor.
5. Remove the setting tool.
6. Position fixture; insert fastener and tighten.

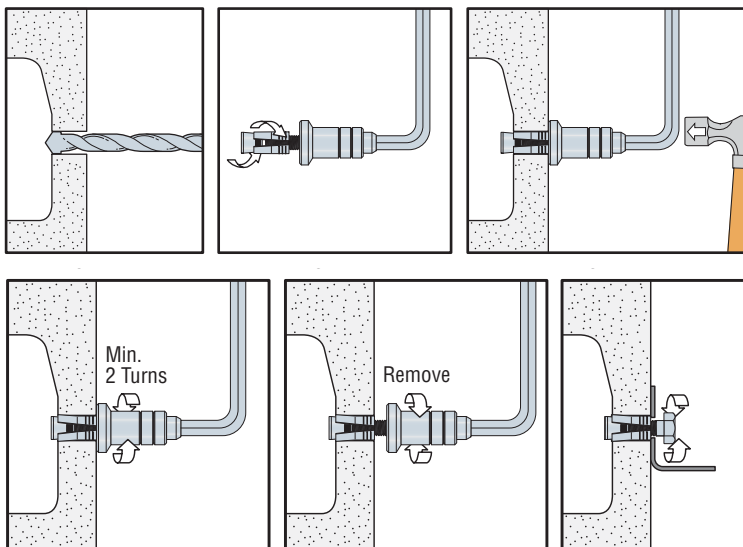
Installation Sequence

LSES Lag Screw Expansion Shield

Installation Instructions:



Caution: Oversized holes may make it impossible to set the anchor and will reduce the anchor's load capacity.

1. Drill a hole in the base material using the appropriate-diameter carbide drill bit as specified in the table. Drill the hole to the specified embedment depth plus $\frac{1}{8}$ " for flush mounting and blow it clean using compressed air. Alternatively, drill the hole deep enough to accommodate embedment depth and dust from drilling. Overhead installations need not be blown clean.
2. Insert anchor into hole. Tap with hammer until flush with surface of base material.
3. Position fixture, insert screw and tighten.

Installation Sequence

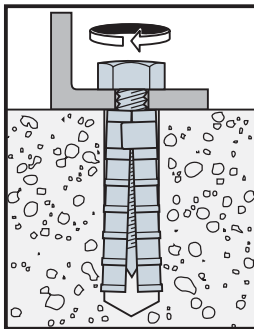
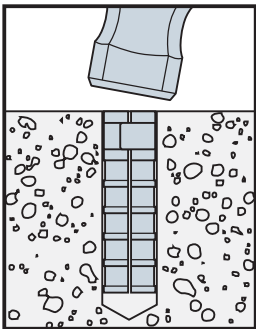
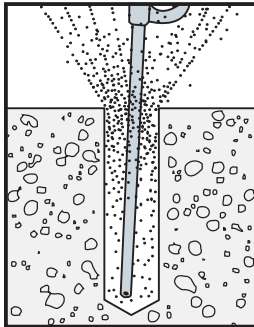
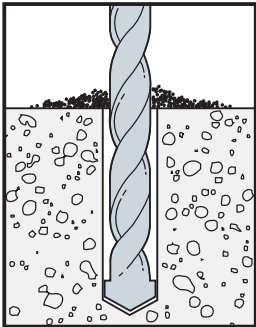

ESA Expansion Screw Anchor

Installation Instructions:

1. Drill a hole in the base material using the appropriate-diameter carbide drill bit as specified in the table. Drill the hole to the specified embedment depth plus $\frac{1}{8}$ " for flush mounting. Blow the hole clean using compressed air. Overhead installations need not be blown clean.
2. Insert anchor into hole.
3. Using a piloted setting punch, drive expander shield over cone.
4. Position fixture, insert fastener and tighten.

Installation Sequence

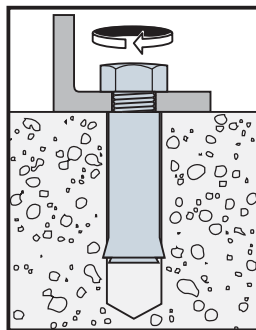
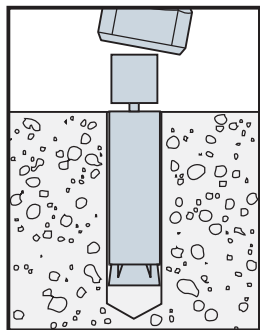
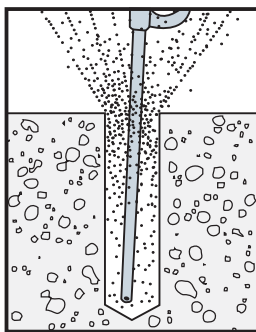
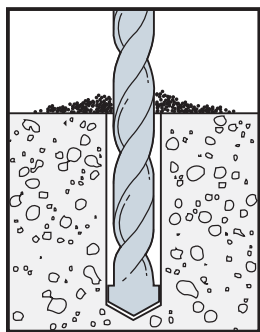

Zinc Nailon™ Pin Drive Anchors

Installation Instructions:



Caution: Not for use in overhead applications.



Caution: Nailon anchors are not recommended for eccentric tension (prying) loads — capacity will be greatly reduced in such applications.

1. Drill a hole in base material using a carbide drill bit the same diameter as the nominal diameter of the anchor to be installed. Drill the hole to specified embedment depth, plus ¼" for pin extension, and blow hole clean using compressed air. Alternatively, drill the hole deep enough to accommodate embedment depth and dust from drilling.
2. Position fixture and insert Nailon anchor.
3. Tap with hammer until flush with fixture, then drive pin until flush with top of head.

Installation Sequence

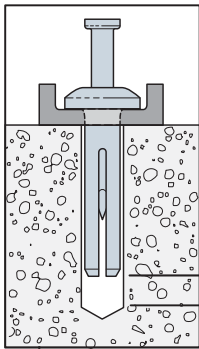
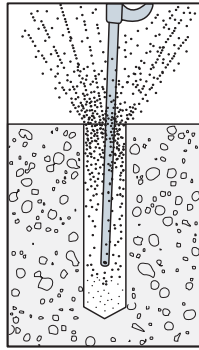
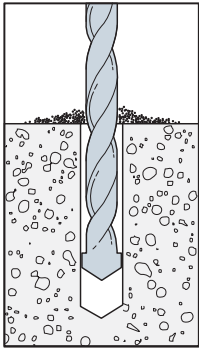

1/4" MIN.

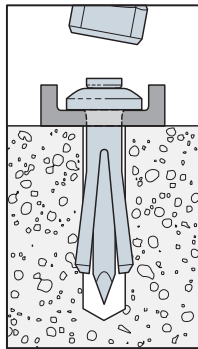

Installation Instructions:



Warning: Industry studies show that hardened fasteners can experience performance problems in wet or corrosive environments. Accordingly, with the exception of the duplex anchor, use these products in dry, interior and non-corrosive environments only.

1. Drill a hole using the specified diameter carbide bit into the base material to a depth of at least ½" deeper than the required embedment.
2. Blow the hole clean of dust and debris using compressed air. Overhead application need not be blown clean. Where a fixture is used, drive the anchor through the fixture into the hole until the head sits flush against the fixture.
3. Be sure the anchor is driven to the required embedment depth. The rod coupler and tie-wire models should be driven in until the head is seated against the surface of the base material.

Installation Sequence

Rod Coupler

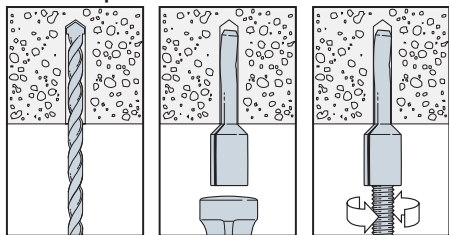

Tie-Wire

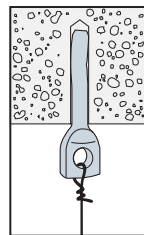

Mushroom Head

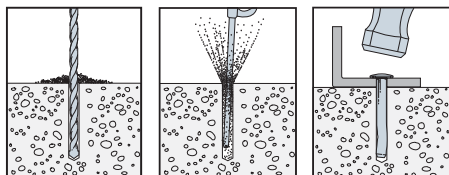

Duplex

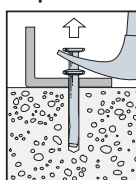

Duplex-head anchor may be removed with a claw hammer

Countersunk Head Installation Sequence

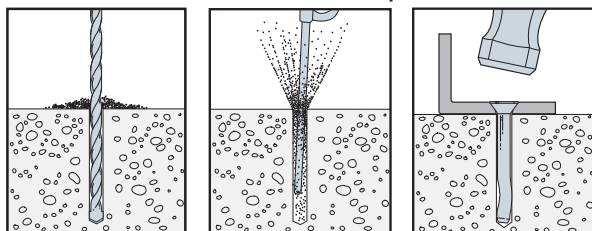

CSD/DSD Split-Drive Anchors

Installation Instructions:



Warning (CSD only): Industry studies show that hardened fasteners can experience performance problems in wet or corrosive environments. Accordingly, use these products in dry, interior and non-corrosive environments only.



Caution: Oversized holes in the base material will greatly reduce the anchor's load capacity. For CSD, embedment depths greater than 1 1/2" may cause bending during installation.

1. Drill a hole in base material using a 1/4"-diameter carbide-tipped drill. Drill hole to specified embedment depth and blow clean using compressed air. (Overhead installation need not be blown clean.) Alternatively, drill hole deep enough to accommodate embedment depth and dust from drilling. Position fixture and insert split-drive anchor through fixture hole.
2. For CSD, 3/8"-diameter fixture hole is recommended for hard fixtures such as steel. For DSD, 5/16"-diameter fixture hole is recommended.
3. Drive anchor until head is flush against fixture.

Installation Sequence

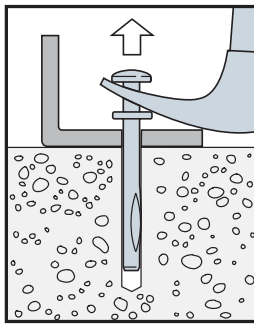
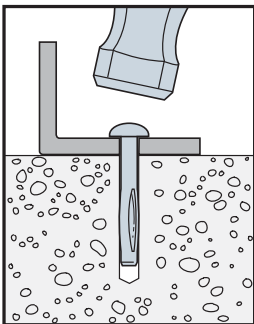
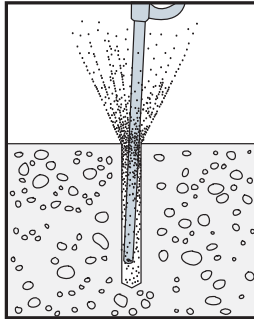
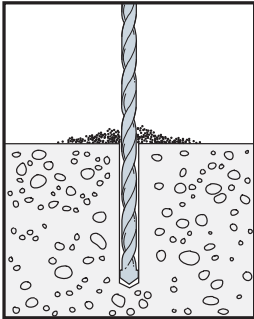

DSD anchor may be removed with a claw hammer

Sure Wall Drywall Anchor

Installation Instructions:

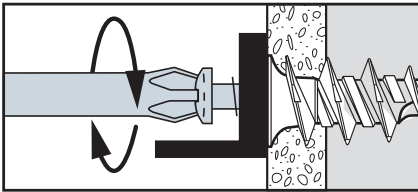
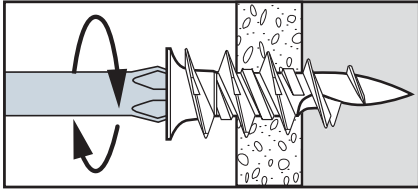
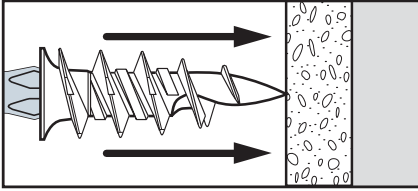

Crack Injection Guide

Cartridge Preparation and Mixing Instructions for Crack-Pac and Crack-Pac Flex-H₂O

After the product is mixed, a small volume of air will remain in the cartridge. Keeping this cushion of air at the back of the cartridge during dispensing will allow the dispensing of the final bit of epoxy from the nozzle once the cartridge is empty.

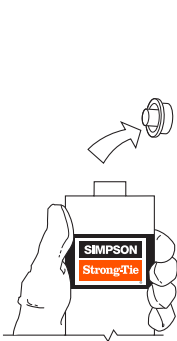

1. Remove the red cap from the top of the cartridge.

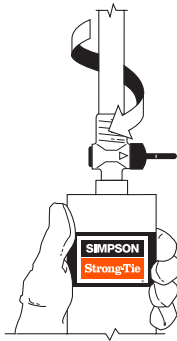

2. Screw the threaded portion of the nozzle into the cartridge.

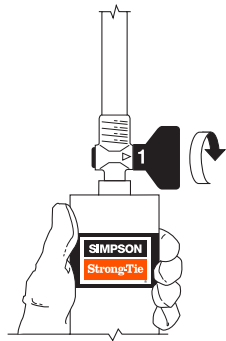

3. Turn the black valve so that the #1 on the valve aligns with the arrow on the neck of the nozzle.

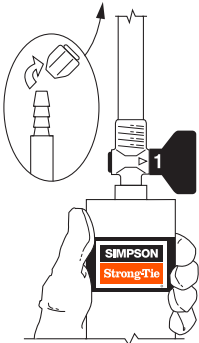

4. Twist off the tip of the nozzle and allow the material contained within to drain into the cartridge.

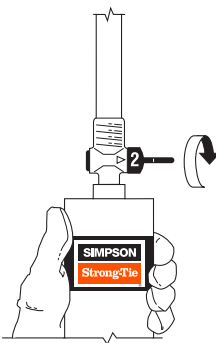

5. Turn the black valve to the #2 position.

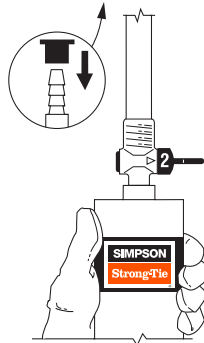

6. Attach the black cap securely to the end of the nozzle.



Wear gloves when handling the Crack-Pac® Flex-H₂O™ cartridge. Eye protection is recommended.

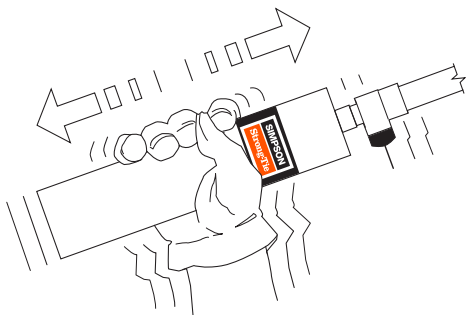

7. Shake the cartridge at a rate of 2 shakes per second for 2 minutes or until the mixed material is a uniform color.

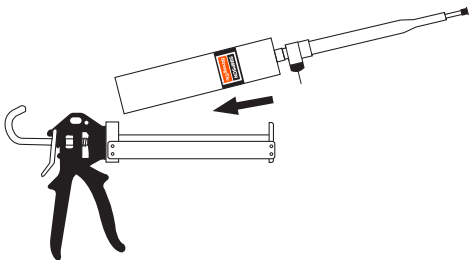

8. Insert the cartridge into the caulking tool.

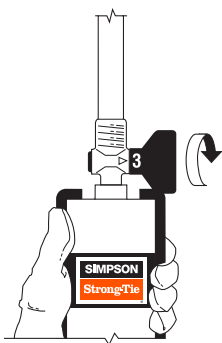

9. Turn the black valve to the #3 position.

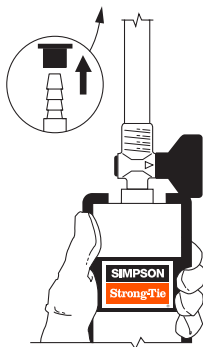

10. Remove the black cap from the end of the nozzle. Attach the E-Z-Click™ injection fitting to the end of the nozzle for injection.



Warning: Do not open cartridge until ready to use. The polyurethane will react to atmospheric moisture if left exposed. To prevent pressure build-up possibly resulting in cartridge breach and injury, remove cartridge from the caulking tool when not dispensing.

Crack Injection Guide



Important: These instructions are intended as recommended guidelines. Due to the variability of field conditions, selection of the proper material for the intended application and installation is the sole responsibility of the applicator.

Epoxy injection is an economical method of repairing non-moving cracks in concrete walls, slabs, columns and piers and is capable of restoring the concrete to its pre-cracked strength. Prior to doing any injection, it is necessary to determine the cause of the crack. If the source of cracking has not been determined and remedied, the concrete may crack again.

Materials

- ETI-SLV for repair of hairline cracks (0.002") and those up to 1/4" in width.
- ETI-LV for repair of fine to medium-width cracks (Suggested width range: 1/64"–1/4").
- ETI-GV for repair of medium-width cracks (Suggested width range: 3/32"–1/4")
- Crack-Pac® injection epoxy for repair of fine to medium non-structural cracks (Suggested width range: 1/64"–1/4")
- CIP-F and ETR are recommended for paste-over of crack surface and installation of injection ports. ET-HP, EDOT™, ETR or SET adhesives may also be used as a substitute. (SET is the only paste-over epoxy approved for NSF/ANSI Standard 61.)
- E-Z-Click™ injection ports, fittings and other suitable accessories.

Crack Injection Guide

Estimating Guide for Epoxy Crack Injection

Width of Crack (in.)	Concrete Thickness (in.)	Approx. Coverage per 22 oz. Cartridge (linear ft.)	Approx. Coverage per 16.5 oz. Cartridge (linear ft.)	Approx. Coverage per 9 oz. Cartridge (linear ft.)
1/64	4	47.7	35.7	18.4
	6	31.8	23.8	12.3
	8	23.8	17.9	9.2
	10	19.1	14.3	7.4
1/32	4	23.8	17.9	9.2
	6	15.9	11.9	6.1
	8	11.9	8.9	4.6
	10	9.5	7.1	3.7
1/16	4	11.9	8.9	4.6
	6	7.9	6.0	3.1
	8	6.0	4.5	2.3
	10	4.8	3.6	1.8
1/8	4	6.0	4.5	2.3
	6	4.0	3.0	1.5
	8	3.0	2.2	1.2
	10	2.4	1.8	0.9
3/16	4	4.0	3.0	1.5
	6	2.6	2.0	1.0
	8	2.0	1.5	0.8
	10	1.6	1.2	0.6
1/4	4	3.0	2.2	1.2
	6	2.0	1.5	1.8
	8	1.5	1.1	0.6
	10	1.2	0.9	0.5

Coverage listed is approximate and will vary depending on waste and condition of concrete.

Crack Injection Guide

Preparation of the Crack for Injection

Clean the crack and the surface surrounding it to allow the paste-over to bond to sound concrete. At a minimum, the surface to receive paste-over should be brushed with a wire brush. Oil, grease or other surface contaminant must be removed in order to allow the paste-over to bond properly. Take care not to impact any debris into the crack during cleaning. Using clean, oil-free compressed air, blow out the crack to remove any dust, debris or standing water. Best results will be obtained if the crack is dry at the time of injection. If water is continually seeping from the crack, the flow must be stopped in order for epoxy injection to yield a suitable repair. Other materials such as polyurethane resins may be required to repair an actively leaking crack.

For many applications, additional preparation is necessary in order to seal the crack. Where a surfacing material has been removed using an acid or chemical solvent, prepare the crack as follows:

1. Using clean, compressed air, blow out any remaining debris and liquid.
2. Remove residue by high-pressure washing or steam cleaning.
3. Blow any remaining water from the crack with clean compressed air.

If a coating, sealant or paint has been applied to the concrete, it must be removed before placing the paste-over epoxy. Under the pressure of injection, these materials may lift and cause a leak. If the surface coating is covering the crack, it may be necessary to route out the opening of the crack in a "V" shape using a grinder in order to get past the surface contamination.

Sealing of the Crack and Attachment of E-Z-Click™ Injection Ports

1. To adhere the port to the concrete, apply a small amount of paste-over around the bottom of the port base (Picture 1). Place the port at one end of the crack and repeat until the entire crack is ported (Picture 2). As a rule of thumb, injection ports should be placed 8" apart along the length of the crack.

Important: Do not allow paste-over to block the port or the crack under it; this is where the injection epoxy must enter the crack.

2. Using a putty knife or other paste-over tool, generously work paste-over along the entire length of the crack (Picture 3). Take care to mound the paste-over around the base of the port to approximately ¼" thick extending 1" out from the base of the port and to work out any holes in the material. It is recommended that the paste-over should be a minimum of ⅜" thick and 1" wide along the crack. Insufficient paste-over will result in leaks under the pressure of injection. If the crack passes completely through the concrete element, seal the back of the crack, if possible. If not, epoxy may be able to run out the back side of the crack, resulting in an ineffective repair.
3. Allow the paste-over to harden before beginning injection. Note: CIP-F and ETR epoxies are fast-cure materials and may harden prematurely if left in a mixed mass on the mixing surface while installing ports. Spreading paste-over into a thin film (approximately ⅛") on the mixing surface will slow curing by allowing the heat from the reaction to dissipate.

Crack Injection Guide

Injection Procedure for ETI-SLV, ETI-LV, ETI-GV and Crack-Pac® Injection Epoxy

1. Follow cartridge preparation instructions on the cartridge label. Verify that the material flowing from the Optimix® mixing nozzle is a uniform and consistent color: for ETI-SLV, the mixed product is black; ETI-LV is transparent amber; and ETI-GV is grey. For Crack-Pac® injection epoxy, verify that the mixed material in the cartridge is a transparent amber color.
2. Attach the E-Z-Click™ fitting to the end of the nozzle by pushing the tubing over the barbs at the end of the nozzle. Make sure that all ports are pushed in to the open position.
3. Attach the E-Z-Click™ injection fitting to the first E-Z-Click™ port until it clicks into place. Make sure that the heads of all the ports are pushed in to the open position. In vertical applications, begin injection at the lowest port and work your way up. In a horizontal application, start at one end of the crack and work your way to the other end.
4. Inject epoxy into the first port until it will no longer flow into the crack. If epoxy shows at the next port and the first port still accepts material, close the second port and continue to inject into the first port until it accepts no more epoxy. Continue closing ports where epoxy appears until the first port refuses epoxy. When the first port reaches the point of refusal, brace the base of the port and pull out gently on the head of the port to close it. Pulling too hard may dislodge the port from the surface of the concrete, causing a leak. Depress the metal tab on the head of the E-Z-Click fitting and remove it from the port.
5. Go to the last port where epoxy appeared while injecting the first port, open it, and continue injection at this port. If the epoxy has set up and the port is bonded closed, move to the next clean port and repeat the process until every portion of the crack has refused epoxy.

While this method may appear to leave some ports uninjected, it provides maximum pressure to force the epoxy into the smaller areas of the crack. Moving to the next port as soon as epoxy appears will allow the epoxy to travel along the wider parts of the crack to the next ports rather than force it into the crack before it travels to the next ports.

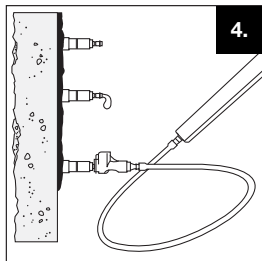

Crack Injection Guide

INJECTION TIPS

- If using a pneumatic dispensing tool, set the tool at a low setting when beginning injection and increase pressure if necessary to get the epoxy to flow.
- For narrow cracks, it may be necessary to increase the pressure gradually until the epoxy begins to flow. It may also be necessary to wait for a few minutes for the epoxy to fill the crack and travel to the next port.
- If desired, once the injection epoxy has cured, remove the injection ports and paste-over. An epoxy-based paste-over can be removed with a chisel, scraper or grinder. The paste-over can be simply peeled off if CIP-F is used. Using a heat gun to soften the epoxy is recommended when using a chisel or scraper.
- Mixing nozzles can be used for multiple cartridges as long as the epoxy does not harden in the nozzle. For injection epoxies in side-by-side cartridges, care must be taken to ensure the level of material is the same on both parts of the cartridge. This can be done by checking for air in the cartridge and the positions of the wipers in the back of the cartridge. If the liquid levels are off by more than $\frac{1}{8}$ ", then Step 1 from the injection procedures must be repeated.

TROUBLESHOOTING

Epoxy is flowing into the crack, but not showing up at the next port.

This can indicate that the crack either expands and/or branches off under the surface of the concrete. Continue to inject and fill these voids. In situations where the crack penetrates completely through the concrete element, and the back-side of the concrete element cannot be sealed (e.g., basement walls, or footings with backfill), longer injection time may not force the epoxy to the next port. This most likely indicates that epoxy is running out the unsealed back side of the crack. In this case, the application may require a gel viscosity injection epoxy (ETI-GV) or may not be suitable for epoxy injection repair without excavation and sealing of the back side of the crack.

Epoxy is leaking from the pasted-over crack or around injection ports.

Stop injecting. If using a fast-cure paste-over material (ETR or CIP), wipe off the leaking injection epoxy with a cotton cloth and reapply the paste-over material. Wait approximately 10–15 minutes to allow the epoxy to begin to harden. If the leak is large (e.g., the port broke off of the concrete surface), it is a good idea to wait approximately 30 minutes, or longer as necessary, to allow the paste-over to cure more completely. Check to see that the epoxy is hard before reinjecting, or the paste-over or ports may leak. Another option for small leaks is to clean off the injection epoxy and use paraffin or crayon to seal the holes.

More epoxy is being used than estimated.

This may indicate that the crack either expands or branches off below the surface. Continue to inject and fill these voids. This may also indicate that epoxy is running out the back side of the crack. If the crack penetrates completely through the concrete element and cannot be sealed, the application may require a gel viscosity injection epoxy (ETI-GV) or may not be suitable for injection repair.

Crack Injection Guide

TROUBLESHOOTING (cont.)

Back pressure is preventing epoxy from flowing.

This can indicate several situations:

- The crack is not continuous, and the portion being injected is full. (See above instructions about injection after the port has reached refusal.)
- The port is not aligned over the crack properly.
- The crack is blocked by debris.
- The injection epoxy used has too high a viscosity.
- If the mixing nozzle has been allowed to sit for a few minutes full of epoxy, the material may have hardened in the nozzle. Attach the E-Z-Click™ fitting to a port at another uninjected location on the crack and attempt to inject. If the epoxy still won't flow, chances are the epoxy has hardened in the nozzle. If so, replace the nozzle.

Less epoxy is being used than estimated.

This may indicate that the crack is shallower than originally thought, or the epoxy is not penetrating the crack sufficiently before moving to the next port. Reinject some ports with a lower-viscosity epoxy to see if the crack will take more epoxy. Another option is to heat the epoxy to a temperature of 80–100°F, which will reduce its viscosity and allow it to penetrate into small cracks easier. The epoxy should be heated uniformly; do not overheat cartridge.

Injection Procedure for Crack-Pac® Flex-H₂O™ Crack Sealer

1. Follow cartridge preparation instructions on the cartridge label. Verify that the material flowing from the nozzle is a uniform green color.
2. Attach the E-Z-Click™ fitting to the end of the nozzle by pushing the tubing over the barbs at the end of the nozzle. Make sure that all ports are pushed into the open position.
3. Attach the E-Z-Click injection fitting to the first E-Z-Click port until it clicks into place. Make sure that the head of the port is pushed into the open position. In vertical applications, begin injection at the lowest port and work your way up. In a horizontal application, start at one end of the crack and work your way to the other end.
4. Inject polyurethane into the first port until material shows at the next port. Remove the E-Z-Click fitting by bracing the base of the port and pulling out gently on the head of the port to close it. Pulling too hard may dislodge the port from the surface of the concrete, causing a leak. Depress the metal tab on the head of the E-Z-Click fitting and remove it from the port.
5. Move to the next port and repeat until all ports have been injected.

Injection Tips for Crack-Pac® Flex-H₂O Crack Sealer

- For narrow cracks, it may be necessary to increase the pressure gradually until the polyurethane begins to flow. It may also be necessary to wait a few minutes for the material to fill the crack and travel to the next port.
- If desired, once the polyurethane has cured, remove the injection ports and paste-over epoxy or hydraulic cement. The paste-over can be removed with a chisel, scraper or grinder.

Crack Injection Guide

Troubleshooting for Crack-Pac® Flex-H₂O Crack Sealer

Polyurethane is flowing into the crack, but not showing up at the next port.

This can indicate that either the crack expands and/or branches off under the surface of the concrete. Continue to inject and fill these voids.

Back pressure is preventing polyurethane from flowing.

This can indicate several situations:

- The crack is not continuous and the portion being injected is full.
- The port is not aligned over the crack properly.
- The crack is blocked by debris.

Polyurethane is leaking from the pasted-over crack or around injection ports.

Stop injecting. If using a fast cure paste-over material (ETR or CIP), wipe off the leaking injection epoxy with a cotton cloth and reapply the paste over material. Wait a approximately 10–15 minutes to allow the paste-over to begin to harden. If the leak is large (e.g., the port broke off of the concrete surface), it is a good idea to wait approximately 30 minutes, or longer as necessary, to allow the paste-over to cure more completely. Check to see that the paste-over is hard before reinjecting or the paste-over or ports may leak.

Another option for small leaks is to clean off the injection adhesive and use paraffin or crayon to seal the holes.

More polyurethane is being used than estimated.

This may indicate that the crack either expands or branches off below the surface. Continue to inject and fill these voids.

Less polyurethane is being used than estimated.

This may indicate that the crack is shallower than originally thought, or the polyurethane is not penetrating the crack sufficiently before moving to the next port.

GRAVITY-FEED PROCEDURE

In some horizontal applications where complete penetration isn't a requirement, cracks can be repaired using the gravity-feed method.

1. Follow cartridge preparation instructions on the cartridge label. Verify that the material flowing from the Optimix® mixing nozzle is a uniform and consistent color: For ETI-SLV, the mixed product is black, while ETI-LV is transparent amber. For Crack-Pac® injection epoxy, verify that the mixed material in the cartridge is a transparent amber color.
2. Starting at one end of the crack, slowly dispense epoxy into the crack, moving along the crack as it fills. It will probably be necessary to do multiple passes in order to fill the crack. It is possible that the epoxy will take some time to run into the crack, and the crack may appear empty several hours after the initial application. Reapply epoxy until the crack is filled.
3. In situations where the crack completely penetrates the member (e.g., concrete slab), the material may continue to run through the crack into the subgrade. It may be possible to use a small amount of coarse, dry sand to act as a barrier for the injection epoxy. Place the sand in the crack to a level no more than ¼" thickness of the member and apply the injection epoxy as described in step 2. The epoxy level will drop as it penetrates the sand, but should cure and provide a seal to the bottom of the crack. Reapply the epoxy until the crack is filled. In some cases, application of sand is impractical or not permitted and epoxy repair may not provide a complete and effective repair. Use of a gel viscosity injection epoxy (ETI-GV) may permit a surface repair to the crack with partial penetration.

Length Identification Head Marks

The following tables define the length of various Simpson Strong-Tie® mechanical anchors based upon the letter stamped on the anchor head. The lengths represented are in inches.

This information pertains to the following Simpson Strong-Tie mechanical anchors:

- Strong-Bolt® 2
- Wedge-All®
- Sleeve-All®
- Torq-Cut™

Length Identification Head Marks

Mark	Units	A	B	C	D	E	F	G	H	I
From	in.	1½	2	2½	3	3½	4	4½	5	5½
Up To But Not Including	in.	2	2½	3	3½	4	4½	5	5½	6

Length Identification Head Marks

Mark	Units	J	K	L	M	N	O	P	Q	R
From	in.	6	6½	7	7½	8	8½	9	9½	10
Up To But Not Including	in.	6½	7	7½	8	8½	9	9½	10	11

Length Identification Head Marks

Mark	Units	S	T	U	V	W	X	Y	Z
From	in.	11	12	13	14	15	16	17	18
Up To But Not Including	in.	12	13	14	15	16	17	18	19

Acceptable Hole Diameter

Mechanical Anchors

Pre-Load Relaxation

Expansion anchors that have been set to the required installation torque in concrete will experience a reduction in pre-tension (due to torque) within several hours. This is known as pre-load relaxation. The high compression stresses placed on the concrete cause it to deform which results in a relaxation of the pre-tension force in the anchor. Tension in this context refers to the internal stresses induced in the anchor as a result of applied torque and does not refer to anchor capacity. Historical data shows it is normal for the initial tension values to decrease by as much as 40–60% within the first few hours after installation. Retorquing the anchor to the initial installation torque is not recommended or necessary.

Adhesive Anchors

Installation into Green Concrete

The strength design data for adhesive anchors in this catalog are based on installations into concrete that is at least 21 days old. Anchors may be installed in concrete less than 21 days old, provided a reduction factor is applied to bond strength:

Products	Concrete Age When Installed	Concrete Age When Loaded	Bond Strength Factor
AT® AT-XP® ET-HP® SET SET-XP®	14 days	21 days	1.0
		14 days	0.9
	7 days	21 days	1.0
		7 days	0.7

Acceptable Hole Diameter

Adhesive Anchors (cont.)

Oversized Holes

The performance data for adhesive anchors are based upon anchor tests in which holes were drilled with carbide-tipped drill bits of the same diameter listed in the product's load table. Additional static tension tests were conducted to qualify anchors installed with SET, SET-XP®, ET-HP® and AT adhesives for installation in holes with diameters larger than those listed in the load tables. The tables indicate the acceptable range of drilled hole sizes and the corresponding tension-load reduction factor (if any). The same conclusions also apply to the published shear load values. Drilled holes outside of the accepted range shown in the charts are not recommended.

SET Adhesive – Acceptable Hole Diameter

Insert Diameter (in.)	Acceptable Hole Diameter Range (in.)	Acceptable Load Reduction Factor
3/8	1/2 – 3/4	1.0
1/2	5/8 – 1 5/16	1.0
5/8	3/4 – 1 1/8	1.0
3/4	7/8 – 1 5/16	1.0
7/8	1 – 1 1/2	1.0
1	1 1/8 – 1 11/16	1.0
1 1/8	1 1/4 – 1 7/8	1.0
1 1/4	1 3/8 – 2 1/16	1.0
1 3/8	1 1/2 – 2 1/4	1.0

SET-XP and ET-HP Adhesives – Acceptable Hole Diameter

Insert Diameter (in.)	Acceptable Hole Diameter Range (in.)	Acceptable Load Reduction Factor
1/2	5/8 – 3/4	1.0
5/8	3/4 – 1 5/16	1.0
3/4	7/8 – 1 1/8	1.0
7/8	1 – 1 5/16	1.0
1	1 1/8 – 1 1/2	1.0
1 1/4	1 3/8 – 1 7/8	1.0

AT Adhesive – Acceptable Hole Diameter

Insert Diameter (in.)	Acceptable Hole Diameter Range (in.)	Acceptable Load Reduction Factor
3/8	7/16 – 1/2	1.0
1/2	9/16 – 5/8	1.0
5/8	1 1/16 – 3/4	1.0
3/4	1 3/16 – 7/8	1.0
7/8	1	1.0
1	1 1/16 – 1 1/8	.75 for 1 1/8 only

Acceptable Hole Diameter

Adhesive Anchors (cont.)

Core-Drilled Holes

The performance data for adhesive anchors are based upon anchor tests in which holes were drilled with carbide-tipped drill bits. Additional static tension tests were conducted to qualify anchors installed with SET and AT anchoring adhesives for installation in holes drilled with diamond-core bits. In these tests, the diameter of the diamond-core bit matched the diameter of the carbide-tipped drill bit recommended in the product's load table. The test results showed that no reduction of the published allowable tension load for SET and AT anchoring adhesives is necessary for this condition. The same conclusions also apply to the published allowable shear loads.

Installation in Damp, Wet and Submerged Environments

SET-XP®, ET-HP® and AT-XP®: The performance data for adhesive anchors using SET-XP, ET-HP and AT-XP adhesives are based upon tests according to ICC-ES AC308. This criteria requires adhesive anchors that are to be installed in outdoor environments to be tested in water-saturated concrete holes that have been cleaned with less than the amount of hole cleaning recommended by the manufacturer. A product's sensitivity to this installation condition is considered in determining the product's "Anchor Category" (strength reduction factor). SET-XP, ET-HP and AT-XP may be installed in dry or water-saturated concrete.

Based on Reliability Testing per ICC-ES AC308

- Dry Concrete – Cured concrete whose moisture content is in equilibrium with surrounding non-precipitate atmospheric conditions.
- Water-Saturated Concrete – Cured concrete that is covered with water and water saturated.
- Submerged Concrete – Cured concrete that is covered with water and water saturated.
- Water-Filled Hole – Drilled hole in water-saturated concrete that is clean yet contains standing water at the time of installation.

SET, EDOT and AT: The performance data for adhesive anchors using SET, EDOT and AT adhesives are based upon tests in which anchors are installed in dry holes. Additional static tension tests were conducted for some products in damp holes, water-filled holes and submerged holes. The test results show that no reduction of the published allowable tension load is necessary for SET, EDOT and AT adhesives in damp holes, or for SET and AT adhesives in water-filled holes. For SET and AT adhesives in submerged holes, the test results show that a reduction factor of 0.60 is applicable. The same conclusions also apply to the published allowable shear load values.

Acceptable Hole Diameter

Adhesive Anchors (cont.)

Based on Reliability Testing per ICC-ES AC58

- **Dry Concrete** – Cured concrete whose moisture content is in equilibrium with surrounding non-precipitate atmospheric conditions.
- **Damp Hole** – A damp hole, as defined in ASTM E1512 and referenced in ICC-ES AC58, is a drilled hole that has been properly drilled, cleaned and then is filled with standing water for seven days. After seven days, the standing water is blown out of the hole with compressed air and the adhesive anchor is installed.
- **Water-Filled Hole** – A water-filled hole is defined similarly to a damp hole; however, the standing water is not blown out of the hole. Instead, the adhesive is injected directly into the water-filled hole (from the bottom of the hole up) and the insert is installed.
- **Submerged Hole** – A submerged hole is similar to a water-filled hole with one major exception – in addition to standing water within the hole, water also completely covers the surface of the base material. Note that drilling debris and sludge should be removed from the drilled hole prior to installation. ICC-ES AC58 does not address this condition.

Glossary

ACI — American Concrete Institute

ACRYLIC — Polymer based on resins prepared from a combination of acrylic and methacrylic esters.

ADHESIVE ANCHOR — Typically, a threaded rod or rebar that is installed in a predrilled hole in a base material with a two-part chemical compound.

ADMIXTURE — A material other than water, aggregate or hydraulic cement used as an ingredient of concrete and added to concrete before or during its mixing to modify its properties.

AERATED CONCRETE — Concrete that has been mixed with air-entraining additives to protect against freeze-thaw damage and provide additional workability.

AGGREGATE — A granular material, such as sand, gravel, crushed stone and iron blast-furnace slag, used with a cementing medium to form a hydraulic cement concrete or mortar.

AISC — American Institute of Steel Construction

ALLOWABLE LOAD — The maximum design load that can be applied to an anchor. Allowable loads for mechanical and adhesive anchors are based on applying a factor of safety to the average ultimate load.

ALLOWABLE STRESS DESIGN (ASD) — A design method in which an anchor is selected such that service loads do not exceed the anchor's allowable load. The allowable load is the average ultimate load divided by a factor of safety.

AMINE CURING AGENT — Reactive ingredient used as a setting agent for epoxy resins to form highly crosslinked polymers.

ANCHOR CATEGORY — The classification for an anchor that is established by the performance of the anchor in reliability tests such as sensitivity to reduced installation effort for mechanical anchors or sensitivity to hole cleaning for adhesive anchors.

ANSI — American National Standards Institute

ASTM — American Society for Testing and Materials

BASE MATERIAL — The substrate (concrete, CMU, etc.) into which adhesive or mechanical anchors are to be installed.

BOND STRENGTH — The mechanical interlock or chemical bonding capacity of an adhesive to both the insert and the base material.

BRICK — A solid masonry unit of clay or shale formed into a rectangular prism while plastic and burned or fired in a kiln that may have cores or cells comprising less than 25% of the cross sectional area.

CAMA — Concrete Anchor Manufacturer's Association

CAST-IN-PLACE ANCHOR — A headed bolt, stud or hooked bolt installed into formwork prior to placing concrete.

CHARACTERISTIC DESIGN VALUE — The nominal strength for which there is 90% confidence that there is a 95% probability of the actual strength exceeding the nominal strength.

CONCRETE — A mixture of Portland cement or any other hydraulic cement, fine aggregate, coarse aggregate and water, with or without admixtures. Approximate weight is 150 pcf.

CONCRETE BRICK — A solid concrete masonry unit (CMU) made from Portland cement, water, and aggregates.

CONCRETE COMPRESSIVE STRENGTH (f'_c) — The specified compressive load carrying capacity of concrete used in design, expressed in pounds per square inch (psi) or megapascals (MPa).

CONCRETE MASONRY UNIT (CMU) — A hollow or solid masonry unit made from cementitious materials, water and aggregates.

CORE DRILL — A method of drilling a smooth wall hole in a base material using a special drill attachment.

CREEP — Displacement under a sustained load over time.

Glossary

CURE TIME — The elapsed time required for an adhesive anchor to develop its ultimate carrying capacity.

DESIGN LOAD — The calculated maximum load that is to be applied to the anchor for the life of the structure.

DESIGN STRENGTH — The nominal strength of an anchor calculated per ACI 318, ICC-ES AC193 or ICC-ES AC308 and then multiplied by a strength reduction factor (ϕ).

DROP-IN ANCHOR — A post-installed mechanical anchor consisting of an internally-threaded steel shell and a tapered expander plug. The bottom end of the steel shell is slotted longitudinally into equal segments. The anchor is installed in a pre-drilled hole using a hammer and a hand-setting tool. The anchor is set when the tapered expander plug is driven toward the bottom end of the anchor such that the shoulder of the hand-setting tool makes contact with the top end of the anchor. A drop-in anchor may also be referred to as a displacement controlled expansion anchor.

DYNAMIC LOAD — A load whose magnitude varies with time.

EDGE DISTANCE:

EDGE DISTANCE (C) — The measure between the anchor centerline and the free edge of the concrete or masonry member.

CRITICAL EDGE DISTANCE (C_{cr} or C_{ac}) — The least edge distance at which the allowable load capacity of an anchor is applicable without reductions.

MINIMUM EDGE DISTANCE (C_{min}) — The least edge distance at which the anchors are tested for recognition.

EFFECTIVE EMBEDMENT DEPTH — The dimension measured from the concrete surface to the deepest point at which the anchor tension load is transferred to the concrete.

EMBEDMENT DEPTH — The distance from the top surface of the base material to the installed end of the anchor. In the case of a post-installed mechanical anchor, the embedment depth is measured prior to application of the installation torque.

EPOXY RESIN — A viscous liquid containing epoxide groups that can be crosslinked into final form by means of a chemical reaction with a variety of setting agents.

EXPANSION ANCHOR — A mechanical fastener placed in hardened concrete or assembled masonry, designed to expand in a self-drilled or predrilled hole of a specified size and engage the sides of the hole in one or more locations to develop shear and/or tension resistance to applied loads without grout, adhesive or drypack.

FATIGUE LOAD TEST — A test in which the anchor is subjected to a specified load magnitude for 2×10^6 cycles in order to establish the endurance limit of the anchor.

GEL TIME — The elapsed time at which an adhesive begins to increase in viscosity and becomes resistant to flow.

GROUT — A mixture of cementitious material and aggregate to which sufficient water is added to produce pouring consistency without segregation of the constituents.

GROUTED MASONRY (or GROUT-FILLED MASONRY) — Hollow-unit masonry in which the cells are filled solidly with grout. Also, double or triple-wythe wall construction in which the cavity(s) or collar joint(s) is filled solidly with grout.

HOT-DIP GALVANIZED — A part coated with a relatively thick layer of zinc by means of dipping the part in molten zinc.

IAPMO UES — IAPMO Uniform Evaluation Service. An ISO 17065 ANSI-accredited company that issues evaluation reports expressing a professional opinion as to a product's building code compliance.

IBC — International Building Code.

ICC-ES — ICC Evaluation Service. An ISO 17065 ANSI-accredited company that issues evaluation reports expressing a professional opinion as to a product's building code compliance.

Glossary

LEGACY ACCEPTANCE CRITERIA — A past version of an ICC-ES anchor qualification criteria. These are no longer current standards, but are the basis for legacy allowable load data for anchors in concrete. These standards have been replaced by modern standards such as ICC-ES AC193 and AC308.

LIGHTWEIGHT CONCRETE — Concrete containing lightweight aggregate. The unit weight of lightweight concrete is not to exceed 115 pcf.

MASONRY — Brick, structural clay tile, stone, concrete masonry units or a combination thereof bonded together with mortar.

MECHANICALLY GALVANIZED — A part coated with a layer of zinc by means of mechanical impact. The thickest levels of mechanical galvanizing (ASTM B695, Class 55 or greater) are considered to be alternatives to hot-dip galvanizing and provide a medium level of corrosion resistance.

MORTAR — A mixture of cementitious materials, fine aggregate and water used to bond masonry units together.

NOMINAL STRENGTH — The strength of an element as calculated per ACI 318, ICC-ES AC193 or ICC-ES AC308.

NORMAL WEIGHT CONCRETE — Concrete containing normal weight aggregate. The unit weight of normal weight concrete is approximately 150 pcf.

OBLIQUE LOAD — A load that is applied to an anchor, which can be resolved into tension and shear components.

PLAIN CONCRETE — Structural concrete with no reinforcement or with less reinforcement than the minimum specified for reinforced concrete.

PORTLAND CEMENT — Hydraulic cement consisting of finely pulverized compounds of silica, lime and alumina.

POST-INSTALLED ANCHOR — Either a mechanical or adhesive anchor installed in a pre-drilled hole in the base material.

POST-TENSION — A method of prestressing in which tendons are tensioned after concrete has hardened.

POT LIFE — The length of time a mixed adhesive remains workable (flowable) before hardening.

PRECAST CONCRETE — A concrete structural element cast elsewhere than its final position in the structure.

PRESTRESSED CONCRETE — Structural concrete in which internal stresses have been introduced to reduce potential tensile stresses in concrete resulting from loads.

PRETENSIONING — A method of prestressing in which tendons are tensioned before concrete is placed.

REBAR — Deformed reinforcing steel which comply with ASTM A615.

REINFORCED CONCRETE — Structural concrete reinforced with no less than the minimum amount of prestressed tendons or nonprestressed reinforcement specified in ACI 318.

REINFORCED MASONRY — Masonry units and reinforcing steel bonded with mortar and/or grout in such a manner that the components act together in resisting forces.

REQUIRED STRENGTH — The factored loads and factored load combinations that must be resisted by an anchor.

SCREEN TUBE — Typically a wire or plastic mesh tube used with adhesives for anchoring into hollow base materials to prevent the adhesive from flowing uncontrolled into voids.

SCREW ANCHOR — A post-installed anchor that is a threaded mechanical fastener placed in a predrilled hole. The anchor derives its tensile holding strength from the mechanical interlock of the fastener threads with the grooves cut into the concrete during the anchor installation.

SHEAR LOAD — A load applied perpendicular to the axis of an anchor.

SHOTCRETE — Concrete that is pneumatically projected onto a surface at high velocity. Also known as gunite.

Glossary

SLEEVE ANCHOR — A post-installed mechanical anchor consisting of a steel stud with nut and washer, threaded on the top end and a formed uniform tapered mandrel on the opposite end around which a full length expansion sleeve formed from sheet steel is positioned. The anchor is installed in a predrilled hole and set by tightening the nut by torquing thereby causing the expansion sleeve to expand over the tapered mandrel to engage the base material.

SPACING:

SPACING (S) — The measure between anchors, centerline-to-centerline distance.

CRITICAL SPACING (S_{cr}) — The least anchor spacing distance at which the allowable load capacity of an anchor is applicable such that the anchor is not influenced by neighboring anchors.

MINIMUM SPACING (S_{min}) — The least anchor spacing at which the anchors are tested for recognition.

STAINLESS STEEL — A family of iron alloys containing a minimum of 12% chromium. Type-316 stainless steel provides greater corrosion resistance than Types 303 or 304.

STANDARD DEVIATION — As it pertains to this catalog, a statistical measure of how widely dispersed the individual test results were from the published average ultimate loads.

STATIC LOAD — A load whose magnitude does not vary appreciably over time.

STRENGTH DESIGN (SD) — A design method in which an anchor is selected such that the anchor's design strength is equal to or greater than the anchor's required strength.

STRENGTH REDUCTION FACTOR (ϕ) — A factor applied to the nominal strength to allow for variations in material strengths and dimensions, inaccuracies in design equations, required ductility and reliability, and the importance of the anchor in the structure.

TENDON — In pretensioned applications, the tendon is the prestressing steel. In post-tensioned applications, the tendon is a complete assembly consisting of anchorages, prestressing steel, and sheathing with coating for unbonded applications or ducts with grout for bonded applications.

TENSION LOAD — A load applied parallel to the axis of an anchor.

THIXOTROPIC — The ability of a fluid to become less viscous (resistant to flow) under shear, then thicken when the shear force is removed.

TORQUE — The measure of the force applied to produce rotational motion usually measured in foot-pounds. Torque is determined by multiplying the applied force by the distance from the pivot point to the point where the force is applied.

ULTIMATE LOAD — The average value of the maximum loads that were achieved when five or more samples of a given product were installed and statically load tested to failure under similar conditions. The ultimate load is used to derive the allowable load by applying a factor of safety.

UNDERCUT ANCHOR — A post-installed anchor that develops its tensile strength from the mechanical interlock provided by undercutting of the concrete at the embedded end of the anchor.

UNREINFORCED MASONRY (URM) — A form of clay brick masonry bearing wall construction consisting of multiple wythes periodically interconnected with header courses. In addition, this type of wall construction contains less than the minimum amounts of reinforcement as defined for reinforced masonry walls.

WEDGE ANCHOR — A post-installed mechanical anchor consisting of a steel stud with nut and washer, threaded on the top end and a formed uniform tapered mandrel on the opposite end around which an expansion clip formed from sheet steel is positioned. The anchor is installed in a predrilled hole and set by tightening the nut by torquing, thereby causing the expansion clip to expand over the tapered mandrel to engage the base material. A wedge anchor may also be referred to as a torque controlled expansion anchor.

WYTHE — A continuous vertical section of masonry one unit in thickness.

ZINC PLATED — A part coated with a relatively thin layer of zinc by means of electroplating.

Alphabetical Index of Products

AD	Drill Bit Shank Adaptor	152
ADT	Acrylic Dispensing Tools	25
ADTA	Acrylic Battery-Powered and Pneumatic Dispensing Tools	25
AMN	Acrylic Mixing Nozzle	26
ARC	Adhesive Retaining Caps	28
AST	Adhesive Shear Tube	32
AT	Acrylic Adhesive	18
AT-XP	Acrylic Adhesive	12
ATS & ATSP	Acrylic Screens	31
BBMD	Blue Banger Hanger®	64
BBRD	Blue Banger Hanger®	65
BBWF	Blue Banger Hanger®	63
CBMX	One-Piece Core Bit – SDS-MAX Shank	156
CBSP	One-Piece Core Bit – Spline Shank	157
CD	Crimp Drive® Anchor	78
CDBE	One-Piece Core Bit – Ejector Key	157
CDT10S	Adhesive Dispensing Tool	24
CHH	Hex Shank Chisels and Demolition Bits	154
CHMX	SDS-MAX Chisels and Demolition Bits	155
CHPL	SDS-PLUS Chisels and Demolition Bits	153
CHSP	Spline Shank Chisels and Demolition Bits	153
CIP-F	Crack Injection Paste Over	130
CPFH	Crack-Pac® Flex-H ₂ O™ Crack Sealer	128
CSD	Countersunk Split Drive	80
CTRB	One-Piece Core Bit – Center Pilot Bit	157
DIA	Drop-In Anchor	70
DIAB	Drop-In Anchor	66
DIABST	Drop-In Anchor Setting Tool	69
DIAST	Drop-In Anchor Setting Tool	72
DSD	Duplex Head Split Drive	80
DXS	Dust Extraction System Drill Bits	35
EDOT	General-Purpose Epoxy Anchoring Adhesive	22
EDT	Epoxy Dispensing Tools	24
EDTA	Epoxy Battery-Powered and Pneumatic Dispensing Tools	24
EIF	Injection Fitting	131
EIP	Injection Port	131

Alphabetical Index of Products

EMN	Epoxy Mixing Nozzle	26
ESA	Expansion Screw Anchor	76
ET-HP®	Epoxy Adhesive	16
ETB	Hole-Cleaning Brush	32
ETI	Crack Injection Epoxy	124
ETIPAC	Crack-Pac® Injection Epoxy	126
ETR	Epoxy Paste	131
ETS & ETSP	Epoxy Screens	31
EZAC	Easy-Set Pin-Drive Anchor	49
E-Z-Click	Injection System	130
GAC	Gas Pins	89
GCC	Gas Pins	89
GCL	Gas Pins	89
GCN-MEP	Gas-Actuated Concrete Nailer	84
GCT	Gas Pins	89
GDP	Gas Pins	86
GDPS	Gas Pins	86
GDPSK	Spiral-Knurled Gas Pins	87
GFC	Gas Fuel Cell	88
GMR-2	Magnetic Ring	87
GRH	Gas Pins	89
GTH	Gas Pins	89
GTS	Gas Pins	89
GW	Gas Pins	89
GWL-100	Lathing Washer	87
HDIA	Hollow Drop-In Anchor	73
HELI	Heli-Tie Helical Wall and Stitching Tie	132
LSES	Lag Screw Expansion Shield	75
MC	Rebar Cutter Shank – Straight	152
MCP	Plate Cutter Head	151
MCR	Rebar Cutter Head	151
MCS	Rebar Cutter Shank – Spline	152
MCSDM	Rebar Cutter Shank – SDS-MAX	152
MCSDP	Rebar Cutter Shank – SDS-PLUS	152
MDA	“A” Taper Shank Drill Bits	149
MDB	Straight Shank Drill Bits	150

Alphabetical Index of Products

MDBP	Titen Drill Bit / Driver	60
MDMX	SDS-MAX & SDS-MAX Quad Head Bits	147
MDPL	SDS-PLUS Shank Bits	143
MDSP	Spline Shank Drill Bits	148
P22A	.22 Cal. Powder Load – Single, Crimped	110
P22LRSC	.22 Cal. Powder Load – Single, Straight Wall	110
P25SL	.25 Cal. Powder Load – Strip	110
P27LVL	.27 Cal. Powder Load – Single, Long	111
P27SL	.27 Cal. Powder Load – Strip	111
PBXDP	BX Cable Strap	116
PCC	Conduit Clip	116
PCLDPA	Ceiling Clip	114
PDPA	0.157" Shank Diameter Drive Pin	112
PDPAS	.157" Shank Diameter Drive Pin	113
PDPAT	0.157" Shank Diameter Tophat Fastener	114
PDPAW	0.157" Shank Diameter with ¾" Metal Washer	112
PDPAWL	0.157" Shank Diameter with 1" Metal Washer	113
PDPWLSS	0.145" Shank Diameter and 1" Metal Washer – Type-304 Stainless Steel	115
PECLDPA	Ceiling Clip	114
PEPT	Pole Tool / Accessories	90
PEPT-LR	Pole Tool / Accessories	90
PHBC	Highway Basket Clip	116
PHD	Hammer Drive Pin	119
PHN	8mm Head Pin	117
PHNT	8mm Tophat Fastener	118
PHNW	8mm Headed Pin with 1" Washer	118
PHT	Hammer Drive Tool	119
PINW	100 through 300 – 0.300" Headed Pin with 1 7/16" Washer	115
PINWP	100 through 300 – 0.300" Headed Pin with 1 7/16" Plastic Washer	115
PKP	Concrete Forming Pin	119
PP	Piston Plug Adhesive Delivery System	27
PPFT	Piston Plug Adhesive Flexible Tubing	27
PSLV3	¾" Threaded Stud	117
PSLV4	¼" Threaded Stud	116

Alphabetical Index of Products

PT-22A	.22 Cal. Powder-Actuated Tool	106
PT-22HA	Hammer-Activated Powder Tool	108
PT-22P	Powder-Actuated Tool	109
PT-27	.27 Cal. Powder-Actuated Tool	104
PT-27HDA	Heavy-Duty Powder-Actuated Tool	102
PTP-27L	.27 Cal. Auto Powder-Actuated Tool	94
PTP-27LMAGR	.27 Cal. Auto Powder-Actuated Tool with Magazine	94
PTP-27S	.27 Cal. Auto Powder-Actuated Tool	98
PTP-27SMAGR	.27 Cal. Auto Powder-Actuated Tool with Rotating Magazine	98
PTRHA	0.157" Shank Diameter Threaded Rod Hanger	114
RFB	Retrofit Bolt	33
RWH	Horizontal Wood Rod Hanger	62
RWW	Vertical Wood Rod Hanger	62
SET	Epoxy Adhesive	20
SET-XP®	Epoxy Adhesive	14
SL	Sleeve-All® Anchor	50
STB2	Strong-Bolt® 2 Wedge Anchor	41
SWN	Sure Wall Anchor – Nylon	81
SWZ	Sure Wall Anchor – Zinc	81
TCA	Torq-Cut™ Anchor	38
THD	Titen HD® Heavy-Duty Screw Anchor	52
THDB	Titen HD® Heavy-Duty Screw Anchor	52
THD RC	Titen HD® Rod Coupler	55
THD RH	Titen HD® Rod Hanger	61
TTN	Titen® Concrete and Masonry Screw	56
TTNSS	Titen® Concrete and Masonry Screw – Stainless Steel	58
TTNT	Titen® Screw Installation Tool	59
TW	Tie-Wire Wedge Anchor	48
WA	Wedge-All® Anchor	43
ZN	Zinc Nailon™	77

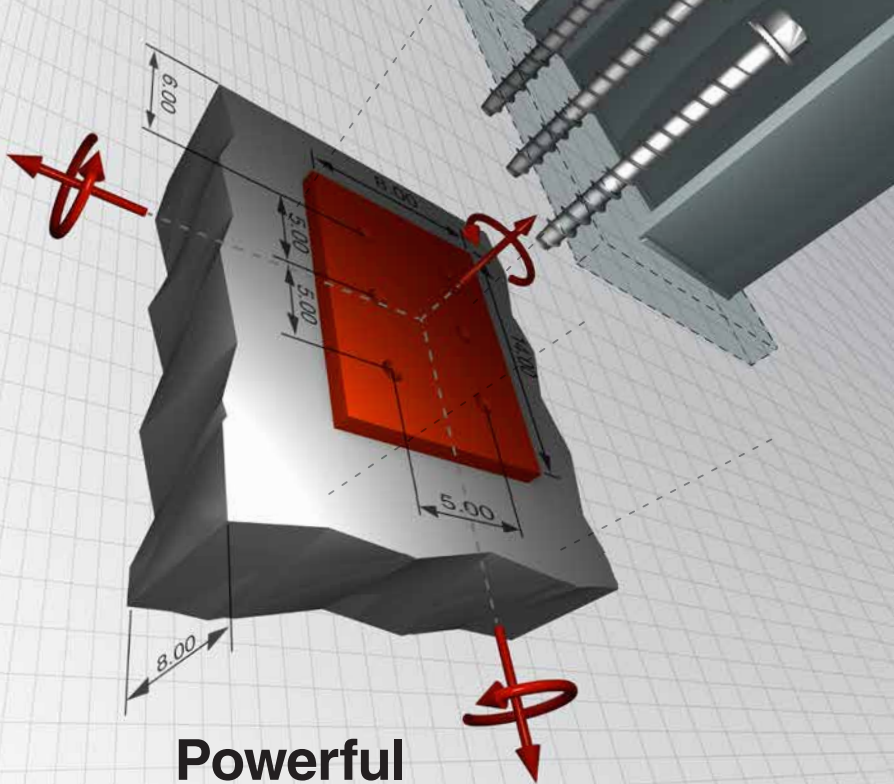

Powerful calculations, *Concrete solutions*



Performing challenging calculations required by current design methodologies can be completed quickly and accurately with the new Simpson Strong-Tie® Anchor Designer™ software. A fully interactive 3D graphical-user interface with 42 pre-loaded anchor configurations simplify input, and calculation results are output for verification and submission of your design. Anchor Designer complies with current ACI 318, ETAG and CSA code requirements.

Call (800) 999-5099 to learn more and download the free software at strongtie.com/anchordesigner.

